

# PONTELAND

B O W L I N G C L U B

Centenary Year 1923 - 2023



## PAST AND PRESENT

*Bernard D.W. Wright*

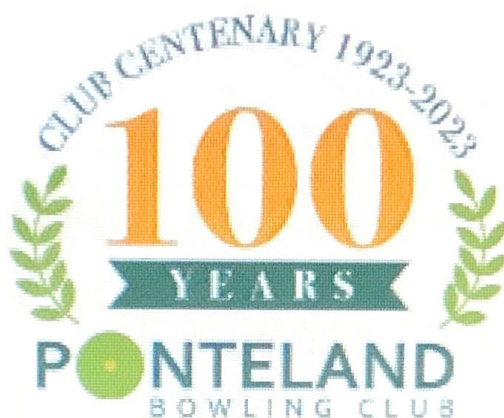

# PONTELAND BOWLING CLUB

Past AND Present

1923 - 2023

*September 2023*

*Bernard D.W. Wright*  
(Honorary Life Member)

# Contents

<b>Acknowledgements</b>	<b>5</b>
<b>Anonymous Tyneside Poem</b>	<b>6</b>
<b>Poem by Miss Jean Trimble of the Ladies' Section</b>	<b>7</b>
<b>Preamble</b>	<b>8</b>
<b>List of Abbreviations</b>	<b>10</b>
<b>Introduction</b>	<b>11</b>
<b>1. PBC Activities</b>	
<b>1.1 Men's Section</b>	<b>14</b>
<b>1.2 Ladies' Section</b>	<b>52</b>
<b>1.3 Combined Sections</b>	<b>78</b>
<b>1.4 Financial Review of Social Activities</b>	<b>107</b>
<b>1.5 Honorary Membership</b>	
<b>1.5.1 Men's Section</b>	<b>108</b>
<b>1.5.2 Ladies' Section</b>	<b>108</b>
<b>1.6 Fund-raising Summary, 1935 - 2022</b>	<b>109</b>
<b>2. PBC Fixtures &amp; Results</b>	
<b>2.1 Men's Section</b>	<b>110</b>
<b>2.2 Ladies' Section</b>	<b>118</b>
<b>2.3 Friendly Fixtures</b>	<b>122</b>
<b>2.3.1 Regular Fixtures</b>	<b>122</b>
<b>2.3.2 Tourists</b>	<b>123</b>
<b>3. PBC Domestic Competitions</b>	
<b>3.1 Men's Section</b>	<b>127</b>
<b>3.1.1 Notable Achievements</b>	<b>131</b>
<b>3.2 Ladies' Section</b>	<b>131</b>
<b>3.2.1 Notable Achievements</b>	<b>132</b>
<b>4. Northumberland Executive Committees</b>	
<b>4.1 NCBA</b>	<b>134</b>
<b>4.2 NCWBA</b>	<b>135</b>
<b>5. Northumberland Fixtures and National Competitions</b>	
<b>5.1 NCBA</b>	<b>138</b>
<b>5.1.1 Other Competitions</b>	<b>142</b>
<b>5.1.2 NCBA Presidents' Tours</b>	<b>144</b>
<b>5.2 NCWBA</b>	<b>145</b>

<b>6. Representative Honours</b>	
<b>6.1 Men's Section</b>	<b>160</b>
<b>6.2 Ladies' Section</b>	<b>161</b>
<b>7. The Bowling Green</b>	<b>162</b>
<b>8. Pavilion / Clubhouse Projects</b>	<b>178</b>
<b>9. Modified Retail Price Indices (1919- 2023)</b>	<b>191</b>
<b>10. PBC Officials</b>	
<b>10.1 Combined Sections (2000 - 2023)</b>	<b>192</b>
<b>10.2 Men's Section (1932 - 2023)</b>	<b>193</b>
<b>Men's Section Presidents</b>	<b>196</b>
<b>10.3 Ladies' Section (1967 - 2023)</b>	<b>200</b>
<b>Ladies' Section Presidents</b>	<b>202</b>
<b>11. PBC Domestic Competition Results</b>	
<b>11.1 Men's Section</b>	<b>206</b>
<b>11.2 Ladies' Section</b>	<b>216</b>
<b>11.3 Mixed Competitions</b>	<b>222</b>
<b>12. PBC Membership</b>	<b>227</b>

## **Acknowledgements**

The author gratefully acknowledges the helpful suggestions and information provided by members of Ponteland Bowling Club and, in particular, their assistance in identifying members in some of the photographs included in this narrative.

Also, I am indebted to Stewart Borthwick, Past President and Life Member of Bowls Northumberland, for his help and time-consuming efforts in verifying the County records of our members and providing the results of representative matches played at Ponteland. My thanks also to the late Mrs Pat Weir, formerly Bowls Northumberland Women's Hon. Secretary, for her assistance with the County records of our lady members.

Notwithstanding the above, I wish particularly, to thank Pat, my wife, for her help whilst preparing the printed version of the Club's history in 2007. Now, sixteen years later, an extended and revised online version to commemorate the Club's centennial in 2023 can be seen by a wider audience. Concerning this, my thanks to Brian Foreman for setting up this narrative on the Club's website and to other members who have made it possible.

## Anonymous Tyneside Poem

*' Divvint Knock Th' Old' Uns, Lads'*

W' had a game o' bools one neet  
Doon at wor local green,  
W' tuk on fower fr' Ashin' ton  
The like y' ve nivvor seen!

Their leader waas one ancient chep  
Wi' a limp and a squint in each eye,  
Aa divvint knaa how ' e booled ' is woods  
But ' e got them pritty nigh!

The next waas even owlder still,  
In fact, the forst chep's faather,  
' e allus got a ' toucher ' on  
But how, aa' ll nivvor gather!

The thord bloke waas the youngest one,  
His age waas ninety-fower!  
By God ' e waas a good' un, lads,  
Yer' ve nivvor seen such power!

The skipper's beard waas two yards lang,  
And ' e tuk a nineteen shoe!  
They said ' e booled wi' Francis Drake  
But aa divvint reckon that's true.

We wun the toss, so off wis went,  
The clock struck ha' past sivin;  
Wi' d played ten ends by ha' past ite,  
Then it cum doon from the heaven!

Why! Geordie waas for chuckin it in,  
Joe sez, ' *it's only a shower* ',  
So w' played until the finish came  
About annither ' oor.

They beat us fowerty-sivvin ta three,  
Wi' d nivvor known such shame,  
Wi' d larnt a lisson nivvor t' scoff  
At boolers old ' n lame.

So, divvint knock th' old ' uns, lads  
Nee matter how baaldy ' n wizen' ;  
If y' ivvor want t' bool like them  
Sit doon... and...luk...and lissen!

***A Dreadful Incident That Took Place One Thursday Afternoon Of  
The Summer Of 1994 At Ponteland Bowling Club, Ladies' Section  
or  
The Tale Of The Tights***

by  
Miss Jean Trimble

It happened on one afternoon  
Of a C&S and Jumbles Day  
When we were all upon the green  
And just about to play.

*'I really am most worried  
What happens when I bend?  
I'm absolutely sure there'll be  
A terrifying rend!'*

Now there was Vera Lonsdale  
A-checking of her team  
When suddenly from Elizabeth  
Came a loud almighty scream !

Maria was not daunted  
*'Just put your pants on top  
And this will make quite sure' she said  
'The tights will never drop.'*

*'Vera come here, we need you  
As you're in your white and grey  
Come quickly here now Vera  
There's no time for delay.'*

*'Please hurry' called June Nichol  
'The driver's most irate  
He says if we don't leave right now  
We'll all be VERY LATE.'*

With startled face, our Vera  
Tugged at her own grey locks  
*'I can't' she said 'Elizabeth  
I've on my short white socks.'*

They climbed into the mini-bus  
When Thelma gave a roar  
*'My goodness gracious, where's my  
woods? Behind the Clubhouse door !'*

*'Never mind' said Elizabeth  
Suddenly standing there  
Her face was pink, her hair on end  
And both her feet were bare.*

At last they were all ready  
And settled on the bus  
As Ora said *'Each one of them  
Exhausted by the fuss.'*

Up stood our bold Maria  
*'I'll put this all to rights'*  
She placed her hand inside her bag  
And produced a pair of tights.

Arriving at the match place  
Now Iris Fletcher said  
*'Each member of the C&S team  
Was clutching a sore head.'*

She gave them to our Vera  
Whose face turned very white  
*'Oh goodness me Maria  
These tights are far TOO TIGHT !'*

They stepped onto the bowling green  
Amidst the summer sun  
You'll all be very glad to know  
PONTELAND LADIES WON !

The moral of this story is  
On C&S / Jumbles Day  
Be very careful that you don't  
Have on your skirt of grey.

Be also very sure, my friends  
You do not have your whites  
Or you may easily end up  
In Maria Shuttleworth's TIGHTS !

## **Preamble**

The history of Ponteland Bowling Club (PBC) was first published in book form in 2007. This narrative, marking its Centennial Anniversary, is a factual summary of meetings and events that occurred at the Club. It may be that some will find the events described somewhat repetitive but were noteworthy at the time they occurred-hence, their inclusion. Following the setting up of a new website in 2015, a regular newsletter was made available which provides details of matters discussed at General Purposes Committee (GPC) meetings and social events. In addition, the opportunity has been taken to both edit and describe more fully the Club's activities from those previously published. Arising from unification of the EBA Governing Body on the 1<sup>st</sup> January, 2008 under the umbrella of Bowls England (BE), the Northumberland County Bowling Association has been designated Bowls Northumberland (BN). However, all references prior to 2008 in this narrative of both NCBA and NCWBA records remain unchanged.

With the passage of time much water, mostly tranquil, has passed under the bridge in Ponteland. In many respects, the same can be said of the events that have occurred in the Club since its formation in 1923. During rare periods of turbulence, in most cases, common sense has prevailed.

The records of meetings and social events have been summarised, whilst retaining an insight of the problems faced and the progress made by the Club, albeit from its modest beginning to its present standing in the Northumberland bowling community. As the senior serving member of the Men's Section, having joined the Club in 1967, it is pleasing to record the bowling achievements of its members and those of the Ladies' Section both past and present in local, regional and National competitions, which has brought the Club much credit and recognition.

In preparing this narrative of the Club it has been necessary to browse through hundreds of pages of both hand and type-written records. For the most part, the earlier events up to the mid-1970s have been carefully hand-written and generally are well documented, thereby, easing the task of abridgement. Occasionally, however, some records of meetings are brief with little indication of the Club members' achievements in competitive matches. In such cases, and where considered appropriate, further relevant information has been obtained from Bowls Northumberland.

The voluntary efforts of both Officers and members serving on the Club's various Committees have contributed, in no small measure, to its success in organising social and competitive events. Also, recognition is due to the ladies who worked behind the scenes in social events prior to the formation of the Ladies' Section in 1967. Also, it is worthy to comment that there are past members not mentioned in this narrative who will have played their part in the Club's progress. In this connection, the assistance provided over the years by both the Ponteland Memorial Hall (PMH) Committee and local authorities is acknowledged. Although the combined membership of the Club had fallen significantly in recent years the introduction of Taster Sessions has led to the recruitment of many new members. They have revitalized the Club, improving both the competitions and social activities together with reporting of these events. In general, matters raised mostly at the AGMs relating to the bowling green and the Clubhouse are reported separately in Sections 7 and 8 respectively of this narrative. Many references are made to Officers serving in honorary positions. However, for conciseness and with due respect, the honorary title has been omitted. Since the 1980s, it has generally been the practice in the writing of the Minutes of the Annual, Spring and GPC meetings to include only the forenames or familiar names of members, and shown in Section 12. Again, for conciseness, and in most cases, the initials of forenames are included in the group photographs throughout the text, also the lists of domestic competition winners presented in Section 11.

The following personal anecdote may be of interest.



In the late 1970s a newcomer to the Club enquired whether his 12-year old son could play on the green. The Secretary agreed on the understanding that an adult member is present on the rink.

The young lad enjoyed playing with several members in the evening roll up and his enthusiasm was clearly evident. Indeed, to such an extent, it upset one senior member who approached the Secretary saying, ' That young upstart has the cheek to keep calling me Jim !' The Secretary replied, ' Well, Jim, that is your name, isn't it ?' 'Yes,' said Jim, 'but would you, as the Secretary, mind telling him that he should address me by my surname!' ' No, Jim,' replied the Secretary, ' you go back on to the rink and quietly ask him to call you by your surname until you decide otherwise.' Nothing more was heard of the incident.

From that time on, the lad, Michael Bennett, practised regularly and, four years later, he entered the Club's Singles competition to become the youngest albeit losing finalist. Two years on, and during the next fourteen years at the Club, he played in another twelve Singles championship finals, winning eleven of which nine were in consecutive seasons. In addition, he competed well in other domestic competitions. Michael's achievements are recorded in Sections 3, 5 & 11 of this narrative.

Whilst at Ponteland B.C. Michael made one hundred appearances for the County and was the winner of ten County competitions in seven events. Michael with fellow member, Keith Wood, went on to win both the County and National Pairs' titles and to represent England in 1995 winning the Pairs' title at the British Isles Championships, held in Llanelli. Also, in 1997, Michael represented England in a Series of Home Internationals and remained in the England squad in 1998.

In 1999, to further improve his bowling skills he left Ponteland moving on eventually to three more competitive private clubs to become their Singles' champions whilst continuing to represent the County. Also, in recent years, Michael's son, Daniel, has represented the County in National competitions.

One can learn a lesson from this story concerning the long-term future of the Club. It is not only dependent on its most recent successful recruitment policy. Several years ago, there was limited success in recruiting children from a local school. The principal reason being the absence of suitable coaching by senior members at the Club. Later on, however, several members obtained coaching qualifications which led, in no small measure, to successful results particularly in the ladies' league and County matches. Now, there is the need to encourage young persons in the local area to join the Club. Maybe, they too could possibly achieve recognition in the bowling community similar to the members identified in several sections of this narrative.

It is hoped that the social harmony and competitive spirit of members existing within the Club will ensure that its future remains as one of the premier private clubs in Northumberland. In the words of King George V when he opened the 1924 British Empire Exhibition :

' Let us look back with pride and forward with resolution.'

## List of Abbreviations

<b>AGM</b>	<b>Annual General Meeting</b>
<b>AOB</b>	<b>Any Other Business</b>
<b>BDA</b>	<b>Bowls Development Alliance</b>
<b>BE</b>	<b>Bowls England</b>
<b>BN</b>	<b>Bowls Northumberland</b>
<b>C. &amp; S.</b>	<b>Collins and Shipley</b>
<b>CMBC</b>	<b>Castle Morpeth Borough Council</b>
<b>DHEC</b>	<b>Darras Hall Estate Committee</b>
<b>EBA</b>	<b>English Bowling Association</b>
<b>EBF</b>	<b>English Bowling Federation</b>
<b>EGM</b>	<b>Extraordinary General Meeting</b>
<b>EWBA</b>	<b>English Women's Bowling Association</b>
<b>FSA</b>	<b>Foundation for Sport and the Arts</b>
<b>GBTC</b>	<b>Gosforth Bowlers Touring Club</b>
<b>GPC</b>	<b>General Purposes Committee</b>
<b>HVP</b>	<b>Honorary Vice President</b>
<b>IBB</b>	<b>International Bowling Board (now the World Bowls Board)</b>
<b>IBC</b>	<b>Indoor Bowling Club</b>
<b>NCBA</b>	<b>Northumberland County Bowling Association</b>
<b>NCWBA</b>	<b>Northumberland County Women's Bowling Association</b>
<b>N&amp;DBA</b>	<b>Northumberland &amp; Durham Bowling Association</b>
<b>NEEPCL</b>	<b>North East of England Private Clubs League</b>
<b>NELBL</b>	<b>North Eastern Ladies' Bowling League</b>
<b>NPFA</b>	<b>Northumberland Playing Fields Association</b>
<b>NLC</b>	<b>National Lottery Commission</b>
<b>PBC</b>	<b>Ponteland Bowling Club</b>
<b>PMH</b>	<b>Ponteland Memorial Hall</b>
<b>PPC</b>	<b>Ponteland Parish Council</b>
<b>PTC</b>	<b>Ponteland Town Council.</b>

## Introduction

At a public meeting, held in the local school on the 19th July 1918, it was decided that a Committee should be set up for the purpose of erecting a memorial to the men from the Ponteland area that lost their lives in serving their country during World War I. Also, it was stated that funds were to be collected for the purpose of founding, and establishing, a non-sectarian and non-political institute, and place of recreation, and social intercourse for the advantage or benefit of the inhabitants of the Castle Ward Rural District. It was agreed that the memorial should include an obelisk, memorial hall, bowling green and tennis courts. The land site comprising of 2.5 acres was purchased for £550 in January 1919. Nowadays, this sum would be equivalent to approximately £14,500 per acre which is a relatively small sum when compared with the price of land in Darras Hall being in the region of £700,000 per acre in recent times.

In July 1922 it was decided to appoint as members of a bowling green sub-Committee Messrs W. Ferguson, R.L. Davison and J. Hilton. In order to minimize costs in providing a bowling green, it was intended the work should be undertaken using voluntary labour. However, six months later, little progress had been made on the green and it was decided that the construction work, including the provision of a small wooden pavilion and two tennis courts, should be undertaken by a local contractor for the sum of £535. This sum would have an equivalent value about £39,190 in 2023.

In 1923, the Newcastle Chronicle reported that over 160 were present at a Whist Drive and Dance held in Ponteland Memorial Hall (PMH) which was arranged by its Committee. The proceeds from the function were in aid of the new bowling green.



Ponteland Bowling Club was founded in 1923. The official opening of the green by the Lord Mayor of Newcastle-upon-Tyne, Alderman Stephen Easten (President of Portland Bowling Green Club), duly took place on Wednesday, the 24th September 1924. Sir Hugh Swinburne, on behalf of the contractors, presented the Lord Mayor with a silver jack suitably inscribed to mark the occasion. The Club representatives were the Chairman, J.T. March, and the Secretary, R.L. Davison. Some of the names of dignitaries who attended the opening of the bowling green are included in this narrative, and in a booklet entitled "A History of the Ponteland War Memorial" prepared in 1938 by R.L. Davison.

Following the formal opening of the green the Lady Mayoress delivered the first

jack. Afterwards, a match between the Lord Mayor's team and the Chairman's team resulted in a win for the Lord Mayor's team by three shots.



**Official Opening of Ponteland Bowling Club Green by the Lord Mayor of Newcastle-upon-Tyne, Alderman Stephen Easten, 24th September 1924**

**PBC Chairman : J.T. March**

**PBC Secretary : R.L Davison**

**Among the representative gathering was Miss Easten the Lady Mayoress, Sir Hugh Swinburne, Sir William and Lady Noble, Sir Joseph and Lady Reed, Sir John Fitzgerald, Alderman J.M. Criddle, Rev. F.W. Langton, Councillor and Mrs Rowe also members from PBC and PMH Committee**

The growth and prosperity of the Club is evident in the reports on the excellent efforts of members relating to both social and competitive events. This has led, in some years, to more detailed coverage of activities within the Club. These include excerpts from the Treasurer's reports and financial statistics on costs associated with the maintenance of the bowling green and various pavilion/clubhouse projects undertaken over the years. In this connection, a modified table of Retail Price Indices has been prepared based on statistics from a Parliamentary Economics Research Paper 12-31, covering an extended period 1750 - 2023. For interested members, the indices presented in Section 9 cover the period 1919 - 2023 They can be applied directly to the Club Treasurer's figures quoted throughout this narrative to afford comparison with present- day values. An example is given in Section 9. Other events covered include the social functions arranged in aid of both the Club and PMH, also in Section 1.5 the monies raised for deserving causes.

The achievements of members in both County and National competitions are highlighted in Section 5, and the results of various PBC domestic competitions are presented in Section 11. Friendly fixtures with faith teas are, of course, the life-blood of any sporting institution and, in this connection, the names of the bowling clubs and visiting tourists who have over the years participated in friendly matches are listed in Section 2.

Membership of the Club has been drawn from a wide range of known occupations, viz. accountancy, banking, blacksmith, bricklayer, butcher, café owner, chartered surveyor, collier, choirmaster, clergyman, doctor, engineer, farmer, garage owner, house-builder, ironmonger, magistrate, naval architect, nurseryman, pharmacist,

photographer, policeman, printer, professional footballer, secretary, shopkeeper, stationmaster, teacher, university lecturer, warehouseman, and not forgetting housekeeper.

With the advent of personal computers and word processing software, some members have helped with the various administrative tasks. Mention should be made of the computing facilities initially provided by Mr R. and Mrs E.D. Brown. In 2005, the PBC website was set up by Alan Ridley of the Men's Section having the following address :

<http://www.pontelandbowlingclub.co.uk>

In addition, photographs of members attending social events, Opening Days, Presidents' Days and Annual Prize Presentations were archived onto compact discs, copies of which were made available by the webmaster. Sadly, Alan passed away in July 2015 and Miss Jean Barras accepted the role of website administrator. In 2022, the GPC named Brian Foreman as webmaster to oversee the development of a new website which has the following address.

<https://www.pontelandbowls.com>

Of particular interest, both websites included members' honours boards, current fixture lists including match results, and social activities. Many photographs are now available on the website of various events held at the Club and a representative sample is shown in this narrative.

# 1

## PBC Activities

### 1.1 Men's Section

Section 1.1 deals with the activities of male members and various ladies' events prior to 1967. Following the formation of the Ladies' Section, on the 15th June 1967, their activities are recorded separately in Section 1.2.

Unfortunately, there are no official records available now on PBC activities and of its members during the early years, 1923 - 1933.

In general, matters raised at an AGM relating to the bowling green and the pavilion / clubhouse projects are reported separately in Sections 7 and 8 respectively.

At the annual re-election of Officers held in 1934 there were a Chairman, President, two Vice Presidents, Secretary, Assistant Secretary, Treasurer and Auditor. At the 1936 AGM it was decided a Vice Chairman should be elected and, by 1948, the number of elected Vice Presidents had risen to ten members. During this period both doctors and clergymen had been elected as Vice Presidents.

In October 1934, the tenth AGM was held in The Coates Institute with 26 of the 80 members in attendance. Later on, these meetings were held in other venues viz. the Louisville Children's Home, the Seven Stars Hotel, St Mary's Church Room, Coates Infants' School and the Ponteland Memorial Hall onwards from 1968. In 1934, the Treasurer reported the finances comprised of £31 6s. 3d in its current account and £12 6s. 9d in the Pavilion Building Fund. Treasurer's reports were subsequently provided until 1938 showing an average balance of £25 in the current account. Also, at the 1934 meeting, consideration was given to a thorough revision of the Club Rules by the General Committee. Besides the General Committee, there was a Selection Committee and a Competitions Handicap sub-Committee, also for the Club's representatives at the Northumberland & Durham B.A. (N&DBA) and the English Bowling Federation (EBF) meetings.

The revised Club Rules and Bye-Laws were subsequently incorporated in the 1935 Fixtures List. It was hoped the contentious issue, of players not playing or completing their games by the due dates in the domestic competitions, would be resolved. Unfortunately, this has proved to be a perennial problem and frequently recorded in the minutes of annual meetings. In January 1935, the Committee enquired whether the lady helpers at the Club would be willing to form another Ladies' Committee. In the past, they had freely given much of their time assisting in the running of various functions and raising funds for the new Pavilion. Accordingly, a meeting was held in The Coates Institute in March 1935 with thirteen ladies in attendance together with the Chairman and the Secretary. Arising from this meeting, future social activities including Jumble Sales (with hardware and £1 stalls, a bran tub for children, bagatelle competitions etc.) led to various revenue-raising events at regular intervals for both the PBC and PMH. In this connection, at a special ladies' meeting, arrangements were made for Cubs from the local Boy Scouts to distribute six hundred handbills, requesting saleable goods from householders of which they had no further use.

Also, in 1935, a representative from the Club joined the local Sports Committee to help organise the King George V Golden Jubilee Celebrations. In connection with PBC fixtures, it was proposed at the 1935 AGM *"Only members of the Club are allowed to play in matches, and that only players who practice on the green should be chosen*

*for matches.*" That ruling was certainly broken in the 1970s when it proved difficult to get the co-operation of members to play in some of the scheduled friendly matches. Fortunately, during this period, visitors willingly played instead. For the domestic competitions, it was decided to hold the first PBC Supper & Prize Presentation in the Seven Stars Hotel at the end of the season. In 1936, PBC organised a Whist Drive & Dance in aid of the PMH and another for the benefit of the Club, which was scheduled to finish at 1a.m. Clearly, the dances starting after the Whist Drive at 10p.m. were very successful as, later on, some were scheduled to finish at 2 a.m.



**President's Day, circa 1935**

**Standing 12<sup>th</sup> from left : M. Johnstone, E. Morley and E. Forster  
Seated (l - r) : J. Robson, J. Oliver and 3<sup>rd</sup> from right, W.L Hepple**

In 1937, it was decided to hold fortnightly Whist Drives in order to provide funds for seating around the bowling green. In 1938, the Club was invited to send two representatives to a meeting in PMH to discuss ways and means of reducing the debt on PMH. Towards the end of 1938, events in Europe led to some of the members being involved in preparatory work for Air Raid Precautions operations and other civil defence activities. This impacted on the Club's social events including the cancellation of the Annual Supper & Prize Presentation; the prizes being distributed at the 1939 Spring meeting.

During World War II there were no AGMs, the last being held in October 1938. However, several General Committee meetings were held each year. Although PMH Committee were responsible for the costs involved in the maintenance of the green, the Club's General Committee looked after the day-to-day events at the green. The agendas typically covered the ordering of dressings for the bowling green, the supplying or repairing of rubber overshoes for members and visitors (hire charge of 1d), purchasing the printed fixture cards, silver spoons, and organising competition handicaps. Additional agenda items included making arrangements for a series of Whist Drives during the winter months, the Annual Hot Supper and the President's Day Evening

Concert. During the war years, both social and playing activities at PBC were increasingly limited; most of the members being engaged in Air Raid Precaution activities during the evenings.

At the 1941 Spring meeting W. Barrons having served nine years as Secretary resigned from the position to become Chairman for nine years. In appreciation of services to the Club, he was made a life Vice President and received a pair of bowls with a befitting silver-mounted inscription.

In 1941, soldiers from the local camp were allowed to play on the green with fees at half-price. At that time PMH Committee provided rubber over-shoes for visitors and agreed to allow car parking in their grounds. Although the social calendar was greatly reduced during the war several fund-raising efforts, including Whist Drives, were made by the members for Mrs Churchill's "Aid to Russia Fund" in 1943 and the Red Cross Fund in 1945. In addition, proceeds from pennies collected from players participating in the Saturday evening Jumbles competitions were donated to the Royal Victoria Infirmary in 1946, and to the Dunston Hill Emergency Hospital in 1948.

At the 1944 Spring meeting the Secretary commented on the enthusiasm in the Club following the formation of the Ponteland Civil Defence Bowling League. The catalyst was the rink competition, held in 1943, which had been arranged for the "Wings for Victory" Savings Week. In 1944, some of the Club's funds were used to purchase £40 of War Savings Certificates during the "Salute the Soldier Week". The 3% Defence Bonds were realized in 1952.

At the 1945 Spring meeting, attended by 24 of the 80 or more members, a total of 33 positions were filled in the re-election of Officers and Committee members. Two members were appointed to represent the Club on the PMH Committee. It was hoped matters relating to the unsatisfactory condition of the bowling green could be resolved by their presence at these meetings. A dance was organised shortly afterwards in aid of PMH. At the 1945 Annual Prize Presentation and Social Evening, W. Wilson, the nurseryman in Callerton Lane, was presented with a suitably inscribed gold medal in recognition of his winning the prestigious N&DBA J.M. Oubridge Cup. This was the first major trophy to be won by a member from PBC. The Club's reputation was enhanced in future years with notable achievements in various competitions details of which are given in Section 5.1. In April 1946, a Whist Drive and Dance was held in aid of PMH.

Following several general Committee meetings, a decision was eventually taken at an Emergency General Meeting (EGM) held in November 1946 for the Club to become a member of the Northumberland County Bowling Association (NCBA). This change meant the 3-men rink N&DBA Cowen and Sinclair Cup competitions would be replaced by the 4-men rink Clegg Cup and Knight Cup league competitions. Also, there would be other knock-out competitions including the Edwardson Cup, the 4-Bowl Singles "Champion of Champions" for the Deuchar Cup and the Northumberland Challenge Cup. Furthermore, members could enter the various NCBA knock-out competitions, the winners of which would represent the County at the EBA National Championships in London. Arising from this decision a revision of the Club Rules and Bye-Laws ensued in 1948.

The effect of the war on the Club's social activities was apparent when the Annual Whist Drive & Dance was resumed in 1947. In the pre-war years, a dozen or so raffle prizes were available whereas, in 1947, the prizes comprised of a bottle of sherry, a bag of potatoes and two other prizes of a dozen eggs. Needless to say, the prizes were welcomed by the recipients. Again, PMH was a beneficiary on receiving some of the proceeds from that event.





**Saturday Evening Jumbles, circa 1947**



**President's Day, 1949**

**Back Row (l - r) : ? , T.W. Cuthbert, ?**

**Standing (l - r) : W.R. Yates, ? , ? , ? , ? , ? , ? , J. Oliver, J. Morley,  
E. Morley, W.V. Reed, W.S. Douglas, J.M. Moorhead,  
W. Endersby, E. Hopkinson, ?**

**Seated Back Row (l - r) : W.S. Arrowsmith, E. Forster, R.F. Pascoe,  
W. Barrons, ? , E. Stokoe, J. Carr, W.L. Hepple,  
J. Robson and H. B. Stobert**

**Seated Front Row (l - r) : ? , W. Weatman, ? , W. Urwin, G.A. Hall,  
? , M. Johnstone, C.F. Jameson and T. Wintrip**

For several years no records were taken after 1938 of the financial situation. In 1950, the Treasurer reported a balance of £33 in the account and a rising membership of 95. The 1950 Annual Whist Drive, Supper and Prize Presentation programme also included some entertainment provided by a comedian and a local soprano. At this event it was necessary for members to bring their own food which would be pooled, similar to the arrangements for faith teas after playing friendly home matches. Outside caterers were hired, however, for other annual social events and, in the mid-1950s, friends and members were invited to provide musical items in lieu of professional entertainers. Later on, several accordionists, conjurors etc. provided the evening entertainment.

In 1951, a Military Whist Drive with 56 tables, was followed by a Dance and buffet meal in PMH. At an EGM held in September 1951 it was agreed to re-introduce the AGM in the first week of October and to abolish the payment of green fees by members and introduce annual subscriptions. At the 1951 AGM it was agreed that the 53 playing members pay an annual subscription of one guinea for the 1952 season to cover all green fees and entry to the domestic competitions. The 15 non-playing members would pay 2s. 6d. It was further agreed that casual green fees and a sum of £50 p.a. be paid as rental to the PMH Committee for the use of the bowling green. Concerning Club dress, it was decided that members should adopt the wearing of blazers for their matches and a design for a new PBC badge was to be prepared by R. Young. Sad to say, that at this time, there was increasing difficulty in raising teams for friendly fixtures. The efforts of the wives and friends at PBC were suitably recognized in August 1951 when a special Ladies' Day was held followed by a faith tea and prize-giving. It became a regular feature in the Club calendar before the formation of a Ladies' Section in 1967 and the introduction in 1968 of a Ladies' President's Day.

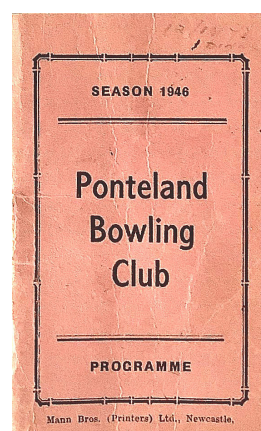

Fixtures Booklet, 1946

On opening the 1952 Spring meeting the Chairman, J. Oliver, referred to the sad and most untimely passing of His late Majesty King George VI and members stood in silent tribute. At a General Purposes Committee (GPC) meeting, a decision was taken that the Annual Social Evening should take the form of a Whist Drive and include the booking of a Quartet and a comedian. At the 1952 AGM it was agreed that all sub-Committees be elected by the GPC from its own membership, and a Senior Vice President, similar to that of the Vice Chairman, be appointed at the time of election of officers. Seven Officers (eight in future years) were elected to form the GPC. Arrangements were finalized for the first Carnival Dance on Christmas Eve in 1952 and a Whist Drive & Dance in February 1953. Also, it was agreed that the Secretary be provided in future with a copy of the 1953 EBA Year Book. In 1953, donations were made to the Ponteland & District Coronation Celebrations Committee and Ponteland Flood Relief Fund.

Over the years regular Whist Drives had been very successful mainly due to the efforts of W. Urwin in raising considerable funds for PBC. In May 1954, as a token of the Club's appreciation of his efforts, he was presented with a pair of bowls suitably inscribed to mark the occasion. The 1954 Annual dinner and Prize Presentation was held in the Wheatsheaf Hotel, Woolsington. For the first time, invitations were sent to the County President, the Secretary and their wives to attend the function. At the 1954 AGM it was decided to dispense with the offices of both Chairman and Vice Chairman, with the President and Vice President respectively fulfilling these duties. In addition, seven Vice Presidents were re-elected.

At the 1955 AGM it was agreed that the proceeds from both Military and Progressive Whist Drives, to be held during the winter, should be donated to the PMH Extension Fund. A total of £32 was raised. The Treasurer stated a new insurance policy covering member's effects held in the Pavilion had been drawn up. A Concert Party was engaged for the annual Social Evening comprising of a Supper and Prize Presentation to be held in PMH.

At the 1956 Spring meeting it was decided to replace the PBC lapel badge with another design, similar to a recently designed blazer badge. In connection with PMH Extension Fund activities the Club was requested to send a representative to attend the newly formed Bazaar Committee. In 1956, prior to the AGM, the GPC submitted an Attendance List of Officials to assist decision-making at future annual meetings. However, without explanation, this helpful practice was discontinued in 1958. At this time, there were approximately 65 members and the annual subscription was £1.5s. 0d. The Annual dinner and Prize Presentation was held in the Wheatsheaf Hotel.



President's Day, 2nd July 1955

Standing (l - r) : ? , P.G. Lloyd, ? , ? , ? , J. Straughan, ? , C.R. Ions,  
 G.A. Hall, ? , ? , T.W. Cuthbert, J. Morley, ? , H.S. Robinson,  
 A. Ridley, ? , ? , ? , ? , ? , ? , R. Yates and A. Robinson  
 Seated, Back Row (l - r) : J. Oliver, W.V. Reed, R.F. Pascoe (President),  
 A. Attwater and E. Forster  
 Seated, Middle Row (l - r) : W. Wilson, J. Robson, W. Weatman, K.B. Straughan,  
 J.A. Ions, W.L. Hepple, E. Hopkinson, ?  
 Front Row (l - r) : T. Nichol, W. Urwin and J. Mitchell

In 1957, the GPC decided to charge members a fee of 4s 0d for entering all the domestic competitions, and 1s 0d for individual entries. It was also decided to accept the invitation from Gateshead B.C. to play friendly fixtures. The Annual dinner and Prize Presentation was held in PMH. In 1958, it was held again in PMH, with an outside caterer who provided a 4-course meal, at a cost of 7s 0d per head, the main dish being steak and kidney pie. As part of the evening entertainment, the President had arranged for some musical items. At the AGM it was agreed that the annual subscription be increased to £1 5s 0d, inclusive of all domestic competition fees. Also, in 1958, a Christmas Eve Dance was held in PMH.

At the 1959 Spring meeting it was reported that the previous year's expenditure was in excess of income. Members would continue to pay existing fees of 2s 6d and 1s

6d for league and friendly matches respectively. The Annual dinner and Prize Presentation was held in PMH but from reports the formal speeches rather spoilt the occasion for some members and friends.

At the 1960 Spring meeting the Treasurer commented on the Club's financial difficulties. The expenditure incurred in 1959 was £50 greater than the income due mainly to the Club subsidizing bus fares for its league and friendly matches. In view of this, it was decided to increase the annual subscription by 80% to £2 5s. 0d. Any members facing hardship were allowed to pay their dues in instalments although, in August 1960, some 25% had failed to pay their subscriptions. In connection with the domestic competitions, it was agreed that each round of the Club Singles ties be played to 21 shots. Also, it was decided to give cash vouchers instead of silver spoons to winners of the Saturday evening Jumbles. Visitors winning a Jumble, however, would still be awarded spoons. The cash vouchers were redeemed by members at the end of the season. Fees remained at 1s 1d for members and 1s 7d for visitors.

In 1960, for the first time, it was decided to hold monthly Committee meetings during the bowling season. Also, members' names, addresses, telephone numbers and payments of annual subscription were publicly displayed on the Pavilion notice board. Of particular concern at the 1960 AGM was the poor support of members in fulfilling friendly matches and its effect on the Club's reputation with fewer friendly matches being arranged. The 1960 Annual dinner and Prize Presentation was held in the Newcastle Airport restaurant (now the Newcastle Aero Club) and followed by the usual Christmas Eve Dance in PMH.



President's Day, 1958

Standing (l - r) : E. Forster, ?, ?, ?, ?, ?, ?, ?, ?, W. Urwin, A. Robinson, ? ,  
G.A. Hall, T.W. Cuthbert, ?, ?, ?, W. Mole and W.V. Reed  
Seated (l - r) : ?, W.L. Hepple, A. Attwater, J. Carr (President), P.L. Lloyd,  
J. Mitchell, A. Ridley and A. Walker

At the 1961 Spring meeting, attended by 27 members, the Treasurer reported a total sum of £50 4s 1d in the Accounts. In connection with domestic competitions, it was decided to return to awarding silver spoons at the Saturday evening Jumbles but none would be awarded to winners of the Straughan Salver. Following a lengthy discussion, it was agreed to accept the recommendation of the GPC to form a Ladies' Committee to assist with the Club's social activities. The 1961 AGM was poorly attended with only 14 members present, possibly a reaction over the poor state of the bowling green or controversy over the forming of a Ladies' Committee. The 1961 Annual dinner with roast duck on the menu at 13s 0d per person, was followed by

entertainment and presentation of prizes in the Newcastle Airport restaurant. This annual function was held in the same venue until 1966. The 1961 Christmas Eve Dance was held again in PMH but proved to be the last occasion as a fund-raising event. It had shown only a net profit of £5, despite the efforts made by members of the Social Committee and, particularly, by the lady helpers.

At the 1962 Spring meeting, attended by 26 members, it was decided, after all, not to proceed with the formation of a Ladies' Committee. This was directly contrary to the decision previously taken at the 1961 Spring meeting. The Treasurer commented on the financial difficulties facing PMH and of the decision taken by PMH Committee to increase the annual rental for use of the bowling green from £50 to £150. In view of this, it was decided to increase the annual subscription to four guineas, an increase of over 85% in just two years, and non-playing members' fees rose to 10s. 0d. In addition, the green fees payable to PMH rose to 1s. 0d per hour. The question raised at a GPC meeting regarding the ladies playing on the green was held in abeyance. At the 1962 AGM a decision was taken to dispense with the annual election of Vice Presidents.

At the 1963 Spring meeting it was decided to introduce Junior membership (aged under 20) with an annual subscription of £2. 2s. 0d. In an effort to recruit new members, handbills were printed and distributed with newspaper deliveries from the local newsagents in Ponteland and Woolsington.

At the 1964 AGM increasing problems over the supervision of domestic competitions and of team selection were discussed. It was agreed to dispense with the 5-member Selection Committee with its duties being taken over by the GPC and ex-officio members. Hopefully, this would ensure members adhered to the completion dates for the various competitions, and were more supportive of the scheduled fixtures. It was further agreed that the PMH Committee be approached seeking permission for the members to play bowls on Sundays. Finally, at the meeting the members present expressed their appreciation of the efforts made by the ladies at the Club's social functions. This would appear to be a backhanded compliment considering the decision taken not to form a Ladies' Committee in 1962.

In 1965, PMH Committee gave the Club permission for its members to play on the bowling green on a Sunday, the fee being 1s. 0d. Green fees for non-members were raised from 1s. 0d per hour to 1s. 6d. Prior to the opening of the 1965 season, the first of many very successful annual Coffee Morning, Bring & Buy Sale and Tombola events was held in PMH.

Following a recommendation from the GPC in April 1967 a significant event occurred in the history of the Club when it was announced, at the 1967 AGM that a Ladies' Section had been formed on the 15th June 1967. The 1967 Annual dinner and Prize Presentation was held in PMH, and held again at this venue until 1973.

In 1968, an annual fee of £30 was payable by the Ladies' Section for regular use of the bowling green; except when the Men's Section had previously arranged fixtures or other competitions. On the social side, in February 1968, a very successful Old-Tyme Dance was held in PMH.

In 1968, the GPC introduced a charge of 3s.1d for non-members wishing to play in Saturday or Holiday Jumbles. A collection box was installed inside the Pavilion entrance to be used by non-members. Another box was made available for donations to the NCBA Benevolent Fund. In April 1968, an excellent profit of £64 was made from the pre-season Coffee Morning held in PMH. In July 1968, the first mention of a Club flag was reported at a GPC meeting. In 1969, the Club took an active part in a special event entitled "Focus Ponteland" to commemorate the official opening of the extension to PMH.

Following many views and opinions expressed at the 1970 AGM it was decided to re-instate the Selection Committee. After the election of Officers, in recognition of services to the Club, a founder member and Past President, C.F. Jameson, was made an Honorary Life Member. He became the first member to receive this award. It is of interest to record that on the 17th March 1919 whilst serving with the Yorkshire Regiment in Sred Mekrenga (North Russia) he was awarded the Military Cross for gallantry and The Royal Order of St Ann by the Russian Government.

At the 1971 AGM, attended by 21 members, much difficulty was found, as in 1970, in electing Officers to serve on various Committees. In the light of this apathy, R.F. Pascoe resigned from the office of Treasurer after 28 years service, which was much regretted by the members. The office was taken over by J.H. Lees for the intervening period until 1978.

At the 1972 Spring meeting amendments to the Club Rules, as proposed by the GPC, were approved and the annual subscriptions rose from £4.25 to £5. The age group of Junior members was changed to 14-18 years with an annual subscription of £1. The following AGM was attended by a very low turn-out of 13 members. A proposal by Gosforth B.C. to form a league for private clubs was discussed and representatives from PBC were appointed to attend a meeting in Gosforth. The Gosforth proposal was accepted and fixtures in the North East of England Private Clubs' League (NEEPCL) commenced in 1973.

At the 1973 Spring meeting it was mentioned that the increasing cost of holding the Annual dinner had led to fewer members attending this event. With this in mind, it was proposed and agreed that a Buffet Supper and Prize Presentation Evening be held instead in the PMH lounge with its bar facilities. For entertainment, some EBA bowls films would be shown with another film of general interest.

At the 1973 AGM it was decided that members representing the Club in competitive fixtures should be attired in a dark blazer complete with PBC badge, grey flannels, brown shoes, white shirt and with a tie to be approved by the GPC. Subsequently, in 1976, white sweaters were made available incorporating the colours of the PBC tie, and personal name badges were introduced. In 1991, the EBA permitted the wearing of white shoes, as an alternative to brown or black smooth flat-soled footwear.

At the 1974 Spring meeting the Treasurer, J.H. Lees, stated that the membership of 40 was eleven less than in the previous year, and reported a balance of £198 in the General Account. Following the untimely passing of the President and Secretary, Harry Emery, whilst returning home from holiday in May 1974, the GPC convened a meeting at which it was unanimously agreed that B.D.W. Wright should act as Secretary (confirmed at the 1974 AGM) and that the Past President, J. Oliver, act as President. It was also agreed that the newly elected Secretary should represent the Club on the PMH Committee. The Annual Prize Presentation Evening which, in addition to the prize-giving, comprised of a buffet and film show was held again in PMH.

Prior to the 1974 AGM each member received for the first time, and at no cost to the Club, an Agenda, a comprehensive type-written Secretary's Report and Minutes of the 1974 Spring meeting. The Secretary considered these would enable members to discuss matters more fully at the meeting, and was received with acclamation. The Treasurer reported entrance fees were to be introduced for the domestic competition viz. £0.10 for the Club Singles and £0.05 for other events. Locker fees were to be increased to £0.25 in 1975.

Further to discussions previously held in several GPC meetings, the members were informed that several applications for grant-aid had been lodged with the local councils for a possible extension of the Pavilion. This project and others are discussed in more detail in Section 8. A great deal of discussion ensued on the proposal by the

Secretary, which had met with the approval of the PMH Committee, for providing extra facilities at the Club with a 600 sq. ft. extension of the Pavilion. In order to raise funds for the Pavilion project, the twenty-two members present at the meeting were urged to recruit friends and neighbours.

In 1974, a waste-paper drive was launched in aid of the Pavilion Fund. Throughout the late summer and the following spring, PBC members had deposited over two tons of unwanted newspapers and magazines in the Pavilion. During the 1974 winter the market rate was £20 per ton. However, an unforeseen slump in the waste paper market, shortly before the opening of the 1975 bowling season, brought this venture to an end with the local Council having to dispose of the entire waste collection.

Friendly fixtures for 1975 were arranged by the Secretary for the first time with two of the Scottish border Clubs, viz. Galashiels and Stow. In connection with Club dress, the GPC approved the design by the Secretary of a tie which was available at a cost of £1 and lapel badges at £0.50. The members agreed with the proposal by the Secretary to provide the membership of both Sections with an annual pocket booklet in 1975. It included the Constitution, Club Officers, competition rules, marking duties, fixtures, members' names with addresses & telephone numbers. It was also agreed that the Ladies' Section, through their Secretary, be officially invited to participate in friendly matches, mixed Jumbles and all the social events of the Club. This was confirmed at the first-ever joint GPC meeting held in November 1974. At this meeting the ladies were informed of the latest events regarding the Pavilion project. The various Pavilion projects undertaken throughout the years are included in Section 8.

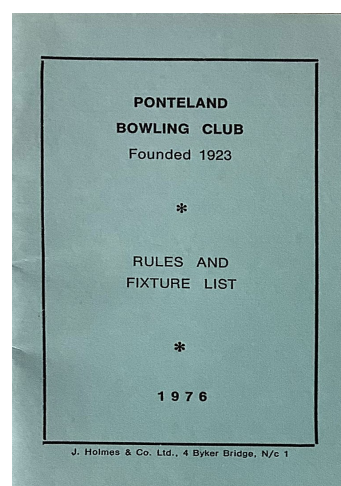

Fixtures Booklet, 1976

Following the introduction of indoor bowling facilities throughout the country in the early 1970s, much interest was shown by the members in learning that an 8-rink indoor green would be opening in Gateshead early in 1975. Previously, during the winter months, the Jesmond swimming baths were closed and boarded over to provide indoor bowling facilities. Some members also had received invitations to play matches during the winter on the small indoor green laid out in the Pavilion of Hexham Elvaston B.C.

When the Ponteland Sports Centre Swimming Pool project was first open to public consultation in the early 1970s, B.D.W. Wright approached the local planning authorities on behalf of the Club, for their consideration of the building of an indoor bowling green above the proposed swimming pool area. Unfortunately, the necessary additional funding required to do this was not forthcoming. Eventually, at the Ponteland Sports Centre with limited floor space available, a multi-purpose hall was used by the Ponteland Carpet Bowls Club, formed in 1974, for playing bowls in a two-hour afternoon session. Later on, this venture received little support when other indoor bowling facilities were opened. This facility was available too at the local Methodist Church.

At the 1975 Spring meeting the Treasurer reported a balance of £212 in the General Account and it was agreed that the annual subscription be increased from £5 to £7. The Ladies' Section agreed to increase their green fee payable to the Club by £10 to £50. At the meeting a first mention was made of a Club Coach, J. Oliver, with his report on coaching arrangements in the County. It was also reported sixteen members had joined a new indoor bowling facility in Gateshead. Sadly, the President, Tom Cattliff,

passed away in August 1975 and the Club had lost successive Presidents whilst in office. Prior to the 1975 Annual Prize Presentation, NCBA Officers were invited by the Secretary to attend the function. Also, arrangements were made for a local professional photographer, Geoffrey Willey, to be present throughout the evening. Subsequently, a suitably annotated album was presented to the Club by the Secretary containing a total of 83 photographs taken at Annual Prize Presentations covering the period 1975 - 1978. A digital archive of the contents of the album is available. These functions were held up to and including 1979.

At the 1975 AGM, in view of the extra work-load due to various Pavilion fund-raising activities, it was decided to amend the Club Rules to include the office of Assistant Treasurer. Following the election of Officers and Committee members, a long-serving member, R. Selby, who was no longer able to bowl, was made an Honorary Life Member and so retained his association with the Club.

At the 1976 Spring meeting the Treasurer reported a balance of £127 in the General Account. It was agreed that W. Mole, an active long-serving member and Past President, who had resigned due to ill-health, be made an Honorary Life Member in recognition of services to the Club. In 1986, PBC was a beneficiary in his will, the legacy being used to provide a memorial seat. During his term in office as President, the Secretary presented the Club with a President's Badge of Office and a gavel set. At the 1976 AGM the first annual draw of the repayable £5 Pavilion "Buy-a-Brick" building bonds was held. The Secretary explained to the members the necessary work required in renovating 640 sq. yards of the green following the mid-season severe damage caused by the exceptionally hot weather. Further details are given in Section 7. In November 1976, following the nomination by the Club, the Secretary was elected to serve on the NCBA League Management Committee.

In September 1976, the Eldon Square, Newcastle indoor bowling green was opened. In 1977, another sports complex was opened at Concordia, Cramlington. Interestingly, the siting of its indoor bowling green on the floor above the swimming pool is similar to the proposal made earlier by the Secretary to Castle Morpeth planning authorities. Further indoor facilities were built at Hexham in 1985 and at West Denton in 2003. Artificial indoor greens have indeed provided the opportunity for both friendly and league matches throughout the winter months. Also, it has provided an opportunity for disabled persons, using special wheelchairs, to play on indoor greens.

In 1977, the annual pre-season Coffee Morning, held in the PMH lounge, proved to be at that time the most successful event when raising over £108. This was attributed to the donations of cash received, and items donated to the Tombola, Cake, Soft Toy, Book and General Stalls. At the 1977 AGM details were given of the maximum grant-aid of £4,000 that could be expected from various authorities in connection with the Pavilion project. Also, in order to assist the Club in financing the cost of re-laying part of the bowling green, which was very severely damaged by the summer drought, a loan of £500, to be repayable over five years at an interest rate of 5%, was available from the Northumberland Playing Fields Association (NPFA). In this connection, the Green's Committee was increased from three to six members to assist with the extra work required on the green. Following the election of Club Officers and Committee members, it was agreed that M. Johnstone be made an Honorary Life Member in recognition of his services to the Club which also included green-keeping duties,

At the 1977 Spring meeting the Treasurer reported a small deficit in the General Account. Members were informed that the Ladies' Section had increased their annual payment from £50 to £75. Any increase in the Men's subscription of £8 was deferred owing to some uncertainty over the condition of the green. It was considered necessary to provide an improved water-hose system to combat the possible effects of another hot summer. It was also stated that Castle Morpeth Borough Council (CMBC) were willing to provide a grant up to £125 towards renovating the green. Some members had



made a considerable financial contribution in providing voluntary labour in re-turfing 640 square yards of the bowling green. Other members were invited to provide donations, if required, to balance the Accounts for 1977. At that time, subscriptions were at a level of approximately £0.05 per day, which may be compared to around £1.00 per day in 2023. It was decided, as a cost-saving measure, to discontinue the popular Club Rules and Fixtures booklet previously issued to members. As a replacement, the Secretary provided a type-written A4 fixtures list. Following the nomination by the Club the Secretary was elected to serve on the NEEPCL Management Committee.

Following the election of Officers and Committee members at the 1977 AGM, attended by 24 members, it was agreed that R.S. Wilkinson, a most respected member, having retired to Teesside, be made an Honorary Life Member. As a token of his appreciation, he donated his set of bowls to the Club. Previously, he made very generous cash donations to the Club. In connection with the Pavilion project, the Secretary reported he was seeking redress from the appointed solicitor as there had been several months' unacceptable delay in processing the application to the Lands Tribunal. So far, grants totalling £2,700 had been received from the Parish and County Councils, the NPFA and Ponteland Rotary Club. Further fund-raising activities were discussed including the suggestion by H. Kinnear to organise a dance which was approved by the GPC. The Secretary briefly explained the efforts made by the Ladies' Section in connection with the Pavilion project, and their donations to the Club funds since their formation in 1967. The regrettable incident which occurred at the end-of-season coffee morning, held in PMH, between a former men's Past President and the President of the Ladies' Section was discussed. Sadly, he refused to apologize for his ungentlemanly reaction over the wearing of the PBC lapel badge by the ladies. It was generally agreed that the Ladies' Section should continue to enjoy the benefits of membership previously extended to them, including the wearing of the lapel badge.

At the 1978 Spring meeting, attended by 23 members, it was agreed that the annual subscription be increased from £8 to £10. In connection with the Pavilion project, the Secretary informed members of the funding schemes available, viz. interest-free loans (varying periods up to five years), donations, £5-"Buy-a-Brick" building bonds (a number of which would be repayable via an annual draw held during a 5-year period), and 5-year compounded annual subscriptions. These schemes were necessary since the maximum possible grant-aid, approximately 66% of the total cost of the project, would be awarded subject to the membership raising the balance. In addition to funds raised at regular coffee mornings, two Buffet Dances & Whist Drives were held in 1978 raising a total of £275 towards the Pavilion Fund. The PMH Committee generously provided the use of its facilities free-of-charge, saving the Club over £100 in expenses. The Secretary referred to subsequent events following their previous meeting. A brief verbal resignation of a former Chairman and President had been received. It was most regrettable that he should display a disapproving attitude towards the ladies following the formation of the Ladies' Section in 1967.

In connection with coaching facilities for members, the Secretary readily agreed to display weekly notices of a regular "teach-in" to be held by R.F. Pascoe, the newly appointed Club Coach. At the end of the meeting the President, T. McPhee, proposed a special vote of thanks to the Secretary who had raised the grass surrounds and turfed the bank-sides on both the eastern and northern sides of the bowling green during the closed season. When the remaining two sides were completed with the assistance of both T. McPhee and W. Middlemiss during the following winter and early spring the bowling green conformed to the required 1949 IBB Standard specification.

At the 1978 AGM much difficulty was experienced in filling the office of both Vice President and membership of the Social Committee. In view of the commitments in 1979 for hosting both the Alfred Bell and J.M. Oubridge Cup competitions these matters were referred back to the next GPC meeting. The President, T. McPhee, agreed to take on the duties of Club Coach. Concerning the bowling green, the President informed

members of the improvements to the green and its surrounds and of the appointment of a part-time greenkeeper who was employed by Ponteland Golf Club. It was agreed that several hand-made gold / silver wire badges at £2.70 each should be ordered as an alternative to the embroidered Club badge. Finally, a draw was made for some of the £5-"Buy-a-Brick" building bonds repayable to subscribing members of the Pavilion Fund.

At the 1979 Spring meeting, attended by 19 members, the Secretary informed members of the request by Portland Bowling Green Club for their matches to be played in white dress which had already been introduced in the NEEPCL matches. This led to white dress being adopted for special occasions at the Club. Members were informed of the laminated plastic bowls markers to be used in matches when representing the Club. The Secretary reported that his nomination by the Club to serve as Junior Vice President of the NCBA had been unsuccessful at the elections held in November 1978. However, he was elected to serve on the NCBA Executive Committee and R.F. Pascoe was re-elected as the County Auditor. Following the retirement of J.A. Main to Devon he was made an Honorary Life Member in recognition of services to the Club, particularly with respect to his work on the Green's Committee. The PMH Committee increased the rental of the bowling green by 10% to £27.50.



**Men's President's Day, 24th June 1978**

(l - r) : Mesdames M. Linthwaite, M. Cassie and H. Bell, ? , Mesdames M.N. Pirnie and C. Mason, M.A. Bennett, G.D. Bennett, H. Kinnear, H. Wood, Mrs B.B. Riddell, J.H. Lees, E. Forster, Mrs M. Stuart, B.D.W. Wright (Secretary), Mesdames G. Cattliff and E. Younger, J.L. Mattison, R.I. Baker, J. Carr (President), J.W. Atkinson, Mrs F.M. Bird (President), G. Longstaff, A.H. Baker, Mrs D. Emery, E.H. Jones, R. Elder, Mesdames M. Little, A.O. MacLeod, E. Mills, M. Peterson, E.M. Roper and L. Stockman, A. Young, T.S. Bruce, T. McPhee and W. Middlemiss

At the 1979 AGM, attended by 19 members, members were informed that a Presentation Supper had been held in Portland Bowling Green Club. The Chairman of the NEEPCL, B.D.W. Wright, received on behalf of PBC a commemorative trophy to record the Club winning in 1974 the inaugural NEEPCL competition. In connection with the Pavilion project, the Secretary stated a letter had been received from a member, a retired bank official, indicating he was not prepared to pay the £20 liability payment levied on all members in November 1977. Ironically, as a Trustee of the PMH Committee he had acted as one of the Applicants in the Club's submission to the Lands Tribunal

for permission to erect a new Pavilion. Even though he attended the Pavilion meetings, the Club was unaware of his opposition to the project. Further to the meeting, the GPC authorized the Secretary to write informing him of the reluctant withdrawal of his membership for refusing to pay the agreed sum of £20 imposed on every member.

In connection with the election of Officers at the 1979 AGM, the Secretary had already informed members at the EGM which was held in March 1979, of his decision to resign from the position of Secretary and membership of the PMH Committee following the cancellation of the Pavilion project. His resignation was confirmed later on at the July 1979 GPC meeting. Prior to the meeting, the outgoing Secretary prepared a note outlining secretarial duties at the Club. However, the secretarial position was left unfilled and its resolution deferred until the next GPC meeting. The detailed content of the job description probably deterred any member from taking up the position. Afterwards, T. McPhee, the Immediate Past President, presented a tankard to B.D.W. Wright for his sterling efforts as Secretary during the period 1974 to 1979, particularly in connection with the Pavilion projects and work around the bank sides of the green. On thanking the members for the gift, B.D.W. Wright mentioned the work undertaken by his wife in typing reports of members' meetings and correspondence for the Pavilion projects and other administrative matters. The Ladies' Section also had appreciated her efforts in co-ordinating the arrangements for the faith teas and for making many soft toys in aid of the Pavilion fund-raising functions.

For the first time, in 1979, the Men's and Ladies' Sections held a combined Prize Presentation with a Whist Drive & Dance in PMH. Unfortunately, the formal speeches rather spoilt the occasion for the ladies and they decided to revert back to their own annual prize presentation in 1980.

At the 1980 Spring meeting, attended by 20 members, the Treasurer reported a balance of £282 in the General Account. Members were informed the Club was now clear of all liability in connection with legal costs arising from the Pavilion project. Consideration was then given to providing a face-lift to the existing Pavilion. It was agreed that a delegation should attend the ladies' AGM the following week to explain the current Pavilion proposal. Members were informed that the position of Secretary was still vacant and J. English, the President and Treasurer, decided to continue acting as Secretary until the next AGM. The Club was indebted to him for shouldering the administrative workload in addition to his presidency. The proposal from the GPC that the annual subscription be increased from £10 to £15 was approved. First-year members would pay £7.50 and Junior membership remained at £1 p.a. It was agreed that the GPC should investigate ways and means of attracting new members including advertising in the local press. Also, it was agreed that an approach should be made to the local school for possible recruitment of junior members. Members were informed that the arrangements for the Spring Dance, organised by J.S. Duff and the Ladies' Section, were well in hand with 120 tickets sold, also the likelihood of another 50 being sold.

At the beginning of the 1980 AGM, attended by 23 members, prizes were presented to the finalists of the domestic competitions, in lieu of a formal evening occasion as in the past. During the election of Officers and Committee members, the position of Secretary was again unfilled and J. English, albeit reluctantly, agreed to continue acting as Secretary. Afterwards, the newly-elected President, E. Scholes, presented commemorative year-badges to eight Past Presidents.

Following talks held with PMH Trustees for an alternative Pavilion scheme, J.S. Duff outlined a proposal to extend the Pavilion. It was estimated that materials could cost £2,500 plus professional labour costs which, hopefully, would be reduced with voluntary help. The Pavilion Fund finances amounted to approximately £1,000 and, with possible financial assistance from both the Ladies' Section and various grant-aid bodies, it was considered a viable scheme. It was agreed that H. Buckley should

prepare plans which would enable PMH Trustees to seek planning permission and make the necessary submissions for grant-aid.

An EGM was held in PMH in January 1981, attended by 41 members from both Sections. Several proposals were considered to extend the Pavilion with only three members objecting to the agreed design. The Ladies' Section indicated they were willing to make a £450 donation towards the cost of the project which was met with acclamation. Both H. Buckley and N.I. Younger, who was not a member at the time, were thanked for their efforts on behalf of the Club.

At the 1981 Spring meeting the Treasurer reported a balance of £485 in the General Account. It was agreed that the annual subscription be increased from £15 to £18, and from £1 to £3 for Junior members. The financial support received from members of both sections with donations and interest-free loans, meant there was more than £3,200 available in the Pavilion Fund. As a revenue-raising venture, it was decided to run an Instant Lottery with tickets at £0.10 and a top prize of £5. For the first time, it was agreed that the Ladies' Section should be invited to play in the men's friendly fixtures with Amble, Morpeth, and Northern Rock B.S. and to participate on separate rinks with the ladies from other Clubs in the NEEPCL matches.

At the 1981 AGM, attended by 23 members, the Treasurer reported that membership had risen 20% to 60 with a balance of £1,231 in the General Account. During the election of Officers and Committee members J. Graham agreed, albeit with some hesitation, to take over the duties of Secretary. In recognition of services to the Club it was agreed that W. Middlemiss, a non-playing member at the age of 90, should be made an Honorary Life Member. Due to career commitments, B.D.W. Wright did not seek nomination for re-election to the NCBA Executive Committee. A proposal by both J. English and B.D.W. Wright, also endorsed by the GPC, for a new Rule 16 permitting Associate Membership, was approved by the members. Also, members agreed that the Ladies' Section should be able to participate in a mid-week evening league which would require two rinks for up to eight weeks during the season. In November 1981, G.D. Bennett organised a successful "Bandit" scheme, helped by both E. Scholes and J. English with ticket sales, which regularly made profits of well over £200 p.a. towards Club funds.

At the 1982 Spring meeting, attended by 32 members, the matter of raising the height of the wall running alongside PMH was discussed on the grounds of safety. It would also be a preventative measure against youngsters and animals running across the green. Members agreed to add an extra £1 to their subscription to provide crockery for the Pavilion as the Ladies' Section had already bought the cutlery. Lockers would be available at £1 p.a. It was reported that work on the Pavilion was well advanced but more volunteers were required. The members agreed with a proposal submitted by T.W. Cuthbert and J.S. Duff, as members of the Pavilion working party, for their able Chairman, N.I. Younger, to be invited to open the extended Pavilion on the Opening Day of the new season. However, for no known reason, the ceremony was performed by the Mayor of CMBC, Cllr W.J. Lough. The fore-mentioned members of the working party were presented with suitably engraved tankards in recognition of their efforts in connection with the Pavilion extension project.

At the 1982 AGM the Treasurer reported membership had risen to 72 and that finances were highly satisfactory with a balance of £2,359 in the General Account. In connection with the maintenance of the green and its surrounds, it was agreed that professional help should be sought. In view of the uneven wear on the green in 1983, consideration was given to altering the direction of play at 5 p.m. each day.

At the 1983 Spring meeting it was announced the Club was now in a position to repay the interest-free loans from members and to wind up the Pavilion Account. In view of increasing costs arising from a revised local rating evaluation, the level of

subscription was raised £2 to £20 with new members paying £10 and no change in other subscriptions. In connection with social activities, J.S. Duff organised a Spring Dance and the Ladies' Section arranged a Hot Pie & Pea Supper and another dance. The GPC decided to invest £100 of Club funds in Premium Bonds (to be held in the name of the Treasurer) which proved to be a sound investment and mentioned later.

At the beginning of the 1983 AGM, attended by 40 members, a prize presentation was held for the domestic competitions. Later, it was decided that the presentation of prizes would take place during the end- of- season Ladies v. Gents match. The Treasurer reported a balance of £3,334 in the General Account, a contributing factor being the highly successful dances held by both the Ladies' and Men's Sections. During the election of Club Officers and Committee members it was decided that the respective Green's, Team Selection and Social Committees should be incorporated within the GPC. Also, at the meeting, it was agreed that two Past Presidents and long-serving members, J. Carr and E. Forster, be made Honorary Life Members in recognition of their services to the Club. Members also agreed to support the proposed application by the Ladies' Section for affiliation to the NCWBA.

At the 1984 Spring meeting, attended by 41 members, the Treasurer reported that the Ladies' Section, in addition to other fund-raising activities, had increased their annual payment by £165. It was suggested that the ladies should be offered full membership of the Club. In the light of this, it was decided the GPC should review the Constitution of the Club and consider the changes necessary to provide the Ladies' Section the same privileges as the Men's Section. It was agreed that future General meetings should be held on Friday evenings instead of Thursdays. It was also agreed that W. Wilson, a most respected member, be made an Honorary Life Member in recognition of his services to the Club over many years.



President's Day, 1980

(l - r) : Mesdames F. Owen and M. Linthwaite, ? , A.S. Lane, W. Middlemiss, Mesdames M. Cassie and M. Shuttleworth, H. Buckley, R. Elder, Mrs M. Little (President), S.A. Swift, D. Dunn, Mesdames M. Duff, B.B. Riddell and D. Emery, G.D. Bennett, J.C. Tingcombe, E. Scholes, M.A. Bennett, Mrs L. Stockman, J. English (President), E. Forster, Mesdames J. Carmichael and E.M. Roper, P. Manson, Mesdames A.O. MacLeod and G. Cattliff, J. Carr, Mrs L. Barrons, T. McPhee, J.W. Crabb, H. Kinnear, J.S. Duff, A.H. Baker, Mrs C. Mason and J.H. Lees



**Men's President's Day, 1981**

**Back Row (l - r) : M.A. Bennett, N. Younger, M. Wearmouth, J. Stoker, G. Linley, E. Forster, J.W. Crabb, J.H. Lees, G.D. Bennett, B. Armstrong, Mrs B.B. Buckley, H. Buckley, Mrs D. Dunn, D. Dunn, Mesdames O.M. Carr and K. Baker, W. Middlemiss, ?**

**Front Row (l - r) : R. Elder, J.S. Duff, J.W. Nesbit, J. English, Mrs M. Shuttleworth, P. Manson, S.A. Swift, Mesdames H. Bell, M. Duff and A.O. MacLeod, J. Tingcombe, Mrs J. Scholes, E. Scholes (President), Mesdames M. Cassie, F. Owen (President), L. Stockman and D. Emery, J.W. Atkinson, Miss M. Myers, A.H. Baker, Mesdames J. Carmichael, W.O. Carse and E. Younger, J. Carr, Mesdames L. Barrons and C. Mason, R.I. Baker, Mesdames M. Little and M. Baker**



**Opening Day, 1982**

**(l - r) : D.L. Walker, E. Forster, J.W. Crabb, M.A. Bennett, G.D. Bennett, M. Wearmouth, S.A. Swift, ? , ? , C.F. Neale, D. Dunn, Mesdames E. Mills, W.O. Carse and L. Stockman, B.D.W. Wright, Mesdames L. Barrons (President), ? , M. Stuart, ? , M. Shuttleworth, M. Cassie, ? , ? , M. Duff and ? , R.I. Baker, G. Linley, Mrs D. Emery, ? , ? , A. Young, W. Johnston, Mesdames F.M. Bird and A.O. MacLeod, J.W. Atkinson, ? , H. Buckley, A.S. Lane, Mesdames H. Bell and E. Younger, R. Stonehouse, Mesdames F. Owen and B.B. Buckley, ? , ? , A.H. Baker (President), P. Manson, ? , J.R. Linley, Mesdames ? , M. Peterson, ? , J. Graham and ? , J.S. Duff, R. Elder, ? , N. Younger, T. McPhee, J. Lunn, J. Carr and ?**

At the 1984 AGM the Treasurer reported the level of membership had risen to 93 similar to early post-war levels. Members were informed that a meeting had taken place, between the GPC and the Ladies' Section Committee, at which it was agreed that the ladies be made affiliated members of the Club. Also, the Ladies' Section were to remain autonomous, but to continue under the jurisdiction of the GPC as constituted at present.

At the 1985 Spring meeting the Treasurer reported a balance of £2,460 in the General Account. Members were informed of the charge of £300 being imposed by PMH for the next financial year. The annual rental charge of £50 remained unchanged, but an additional charge of £250 was necessary to cover expenses to be borne by PMH Trustees. Also, the insurance of Club trophies, previously arranged by the Trustees, was withdrawn. Following the meeting, an EGM was held to ratify the revision of Club Rules and Regulations as drawn up by the GPC. President, G.D. Bennett, informed members that his employer, GRE Insurance, had agreed to sponsor a Mixed Triples competition with £100 in prize money to commemorate his year in office.

At the 1985 AGM members were informed that the Ladies' Section had paid for the installation of a water heater in the kitchen. This would give all members the opportunity to attend the coffee mornings in the Pavilion during the winter months. Members also expressed their gratitude to the Ladies' Section for their contribution of £1,000, in addition to their affiliation subscription, towards Club funds. During the election of Officers and Committee members, J.S. Duff volunteered to take on the duties of Club Coach and J. English agreeing to manage the domestic competitions.

At the 1986 Spring meeting the Treasurer reported a balance of £1,785 in the General Account. With a membership approaching 100 in the Men's Section, the Green Ranger suggested consideration be given to imposing a restriction on the admission of prospective new members. It was also suggested that the condition of the bowling green might improve if members bought copies of the EBA booklet "Rules and Guide To Bowls". Members were in agreement with the proposal put forward by the Northumbria Police that the Club entertain two touring Police teams in 1986. The Ladies' Section also requested permission to host a NCWBA match against Yorkshire in May 1986 which was approved. It was also agreed that a new Ladies' Section competition, the Joyce Carmichael Triples Trophy, be held in June 1986. In April 1986, members were invited to a Fish & Chip Supper with bar facilities in PMH, arranged by the Ladies' Section, in aid of the Cancer Relief Fund. Following the very successful GRE Insurance sponsorship of the Mixed Triples competition in 1985, the President, R. Elder, gave the Club three trophies to be presented annually to the winners' of the Mixed Triples competition.

At the 1986 AGM members were informed that a letter of thanks had been received from the League Of Friends of Hunters Moor Hospital for their donation of £40. The money was raised at the Ponteland Village Fair in a Target Bowls competition organised by six members. Also, donations were made to both the EBA Building Fund and the NPFA. Following the election of Officers and Committee members it was agreed that two Past Presidents, T.W. Cuthbert and T. McPhee, be made Honorary Life Members in recognition of their long and invaluable services to the Club and for the County. It was decided that an admission fee of £10 be introduced for new members. In connection with fixtures, it was decided that a member be appointed Team Captain in respect of each match. Also, it was brought to the attention of members that NCBA coaching courses were now available. Hopefully, qualified Club Coaches would be able to assist those who damaged the green when delivering their bowls. This would also benefit all members in reducing green maintenance costs, and thereby, improving the playing surface.

At the 1987 Spring meeting the Treasurer reported a balance of £1,221 in the General Account. Thanks were extended once again to the Ladies' Section for paying

£560 into Club funds in addition to their affiliation subscription. It was decided to increase the subscription of full members from £20 to £23 and Junior members from £3 to £5. It was agreed that arrangements be made to hold an Annual dinner. It was also agreed that the annual competition prizes should be presented once again at the Ladies v. Gents match at the end of the season. During the election of Officers and Committee members at the 1987 AGM W.D. Marshall accepted the new position of Press Officer. Also, it was reported some members had organised a skittles competition at the Ponteland Village Fair which raised £25 for the Ponteland Hospital League Of Friends.



**Opening Day, 1987**

**Men Standing (l - r) :** P. Cordingley, T. Lumley, G.C. Nicholson, W. Robinson, J. Lunn, S.A. Swift, G. Warner, W. Johnston, G. Attwater, ? , R.I. Baker, D.L. Walker, T. Nichol, G. Bowmer, D. Hindmarsh, K. Griffiths, J.S. Duff, A.H. Baker, J. Hoy and J.W. Atkinson

**Ladies Standing (l - r) :** ? , V. Lonsdale, A. Gill, I. Cassidy, M. Myers, M. Duff, L. Stockman, I. Fletcher, K. Armstrong, J. Cosby, E. Younger, ? , F. Jeffs, T. Wright, M.E.H. Nesbit, M. Barclay, B. Johnston, F. Owen, M. Little, D. A. Johnson and M. Shuttleworth.

**Front Row (l - r) :** R. Stafford, S. Wright, R. Elder, F. Jeffs, J. Graham, S. Rutherford, J. English, R. Madison and L. Crofts

**Presidents Mrs N.F. Orttton and J.W. Nesbit**

At a GPC meeting, held in February 1988, it was agreed that the Ladies' Section host a NCWBA match against Yorkshire in May 1988. Also, in May 1988, E.S. Johnson, the Vice President, offered to provide a Vice President's badge which was gratefully accepted by the GPC.

At the 1988 Spring meeting the Treasurer reported a balance of £1,691 in the General Account and a membership of 100. It was agreed to increase the annual subscription by £2 to £25.

At the 1988 AGM, attended by 38 members, J. English the retiring Treasurer recalled some of the notable events during his 14 years as an office bearer. There was a balance in the Accounts of £2,293 but there were some bills yet to be paid. The Club received £50 from a recent National Savings Premium Bond draw. A proposal from the



GPC that the annual subscription be waived for holders of the positions of Hon Secretary and Hon. Treasurer was unsuccessful. Following the election of Officers and Committee members, R.I. Shuttleworth agreed to take over the position of Club Coach. Afterwards, from the floor, J.S. Duff proposed and T. McPhee seconded a motion that the former Secretary and Past President, B.D.W. Wright, be awarded Honorary Life Membership in recognition of notable services to the Club. This was met with the approval of the members present, and it was also agreed that a letter be sent to Miss W.O. Carse of the Ladies' Section, warmly congratulating her on being awarded the B.E.M. for service with the W.R.V.S. over many years.

Prior to the 1989 Spring meeting several changes to the Club Rules and Regulations, as recommended by the GPC, were approved at an EGM attended by 46 members. The principal change was the appointment of Officers and Chairmen of Specialist Committees onto the GPC. It was decided that membership of any one Committee should not exceed three consecutive years. This particular ruling, however, led to problems over the years when electing Officers and Committee members. The Treasurer reported a balance of £1,360 in the General Account. In connection with a recent Clubhouse proposal members were advised that should grant-aid be unavailable, the cost of extending the green would be approximately £3,500. Because of this, the admission fee for new members increased from £10 to £25. The annual subscription to be increased by £3 to £28 and locker fees increased to £2. In 1989, E. Scholes was elected Chairman of the NEEPCL and, in connection with their fixtures, the 1989 Annual Gala Day tournament would be held in Ponteland.

At the 1989 AGM it was reported that J. English, had been nominated to serve as Junior Vice President of NCBA and was duly elected in November 1989. T. Lumley and R.I. Shuttleworth agreed to take on coaching duties at the Club. Following a decision by T.W. Cuthbert to retire from green-keeping activities, R. Stafford was appointed the Green Ranger. With membership of the Club increasing quite rapidly, it was suggested that consideration again be given to providing another extension of the Pavilion.

At the 1990 Spring meeting the Treasurer reported a balance of £2,355 in the General Account. It was agreed that both annual subscription and admission fees be increased to £30. Also, fees for visitors playing on the green to be raised to £2 per person. Members were informed that the Club had again won £50 from a recent National Savings Premium Bond draw.

At the 1990 AGM it was reported that J. English had resigned from the office of Junior Vice President of the NCBA for health reasons. Members were informed that L. Wilson had again expressed concern at the continuing deterioration in the condition of the green. This was most marked at the ends of each rink which were considered to be over-bowled. Members introducing guests wishing to play at the Club were asked to sign a Visitor's Book held in the Pavilion. Members would be responsible for collecting the £1 fee levied per guest. Also, in connection with the Pavilion, the GPC was rightly concerned over the limited accommodation available for an increasing membership. At the request of the GPC, D. Boland had prepared a report on a possible extension of the Pavilion which was presented at the meeting. It was generally agreed that improvements were necessary and, with the permission of PMH Committee, a planning application would be submitted to the local authority. Members were informed that a letter had been received from the local Environmental Health Department requesting action be taken in providing an improved hot water supply in the Pavilion.

Following the untimely and sad passing of John Graham, the President and former Secretary, a meeting of the GPC was held in January 1991. It was agreed that E.S. Johnson, the Past President, should act as President until the 1991 AGM.



**Opening Day, 1988**

**(l - r) : R.I. Shuttleworth, J. English, Mesdames D. Lumley, L. Stockman, E. Younger, M. Cassie, T. Wright, J. Cosby, M. Stuart, M. Bryson, M. Duff and M. Little, P. Cordingley, Mrs I. Fletcher, W. Johnston, Mrs B. Johnston (President), G. Attwater, C. Walters, S.A. Swift (President), J.W. Nesbit, Mrs A. Swift, E.S. Johnson, ? , A.H. Baker, Mrs M. Shuttleworth, G. Warner, Mesdames L. Barrons and M.E.H. Nesbit, L. Crofts, W. Robinson, R. Lyon, J. Graham, Mrs B. Stafford, T. Lumley, S. Wright, A. McMillan, W. Bell, G. Bowmer, K. Griffiths, Miss W.O. Carse, A.M. Maclean, Mrs D. Crofts, J.W. Atkinson, Mrs F. Owen, N.I. Younger, Mesdames M. Myers and K. Armstrong, R. Stafford**

At the 1991 Spring meeting the Treasurer reported a balance of £3,457 in the General Account. It was agreed that the annual subscription be increased by £2 to £32. The Ladies' Section was thanked for making a payment of £836 towards Club finances for 1990 and their "payment on account" of £1,500 towards estimated an expenditure in 1991. Members were also thanked for their revenue-raising efforts including the Domino Drives amounting to £670. In addition, the Club received another £50 from the National Savings Premium Bond draw, which represented a 100% return on the original £100 invested in 1983 (discounting the effects of inflation). The main item on the agenda related to the possible extension of the Pavilion. Contrary to a decision taken at the 1990 AGM and further discussion, it was decided overwhelmingly, not to proceed with the proposal prepared by D. Boland who was, however, thanked for his efforts on behalf of the Club.

Early in 1992 E.S. Johnson accepted the invitation to fill the vacant position of Junior Vice President of the NCBA. At the 1992 Spring meeting the Treasurer reported a balance of £4,566 in the General Account. It was decided that the annual subscription be increased by £2 to £34. Members were informed that the Club had been registered with CMBC, under the 1990 Food Safety Act.

It was reported at the GPC meeting, held in April 1992, that members had agreed to ban smoking in the Pavilion and that appropriate notices should be displayed on the premises.

Celebrating his tenure as President, R.I. Shuttleworth, organised a private bowling tour to the Scarborough area playing three matches over the Spring Bank Holiday. The team included members from both the Ladies' and Men's Sections. The GPC agreed to a request from the Ladies' Section to host a NCWBA match in 1993. E.S. Johnson was elected Senior Vice President of the NCBA in November 1992.

At the 1993 Spring meeting the Treasurer reported a balance of £5,500 in the

General Account. In view of unplanned considerable expenditure incurred by the Club, members agreed to an increase of £6 in their annual subscription to £40. At a meeting, held in March 1993, the GPC agreed to award an honorarium to W.R. Liddle in recognition of the maintenance and repair work regularly undertaken by him at the Club. Also, in connection with the proposed Local 5-Year Plan for Ponteland, B.D.W. Wright had approached the Council regarding them providing a new bowling green at the Sports Centre. A member from each Section subsequently attended a meeting with CMBC representatives who confirmed there was land available for two bowling greens, but little cash. To go ahead, substantial funding would need to be found by the Club. At the GPC meeting, held in April 1993, it was recorded that *"a member of the Ladies' Committee be invited to the GPC meeting whenever any financial capital expenditure, involving the Ladies' Section, is contemplated."*

At the 1993 AGM the Secretary considered the bowling green had played very well despite the considerable amount of rain experienced during the summer. The NCBA League and County Officers complimented the Green's Committee on the appearance of the green and its surrounds. Also, the Club received a letter of congratulations from the PMH Committee on its playing achievements, the attractive appearance of the green and its surrounds and the conduct of its affairs. However, during the meeting, concern was expressed by the Secretary that a charge of £10 was made in providing tea and biscuits for the tourists from Dunnington B.C., Yorkshire and Wigton B.C., Cumbria. In connection with social activities, members welcomed the suggestion that the Ladies' and Men's Sections should hold a joint Annual dinner. In November 1993, E.S. Johnson was elected Senior Vice President of the NCBA. Sadly, he died on the 24th December following a tragic accident at his home.

At the 1994 Spring meeting the Treasurer reported a balance of £3,726 in the General Account. It was agreed that the annual subscription for full members be increased by £4 to £44.

At the 1994 AGM the Secretary made reference to the bowling achievements of two young men at the Club, viz. K.D. Wood and M.A. Bennett, in winning the County Pairs title and the National Pairs title at Worthing. Their success received extensive coverage in the local and national press and gave much publicity to Ponteland B.C. A letter was received from Whitley & Monkseaton B.C. saying *"Not only have they brought distinction to themselves with their achievement but they have also brought credit to your club and Northumberland County. Congratulations to them both."* Members voiced their approval of the sentiments expressed in the letter and agreed that they each be given £50 from Club funds to help towards their expenses at Worthing. Afterwards, the Secretary also spoke of the achievement of Mrs M. Shuttleworth on reaching the Singles Final of the Sanatogen Over 50s All-England Indoor Championships which were held in Wellingborough, Northants and, thereby, providing more publicity for PBC. Also, in recognition of his services to the Club the members present agreed that J. English, Past President and former Treasurer, be made an Honorary Life Member. It was also agreed that R.I. Shuttleworth be nominated to serve on the NCBA Executive.

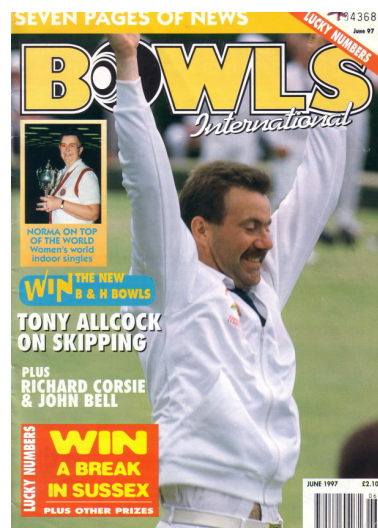

Michael A. Bennett celebrating his selection for England Trial, 1997  
 Courtesy of Bowls International

In connection with the Pavilion, members approved of the decision taken by the GPC to examine the possibility of a worthwhile extension and to appoint J.T. Harrison the role of Chairman of a sub-Committee.

At the 1995 Spring meeting the Treasurer, R.B. Baxter, reported a balance of £4,813 in the General Account. The annual subscription was increased by £4 to £50 and the subscription for Associate members rose to £12. Locker fees were increased to £3. J.T. Harrison then presented a Committee report which included sketch plans and costs relating to a possible extension of the Pavilion. The proposal was well received, and it was agreed that all members should be consulted on the best way to proceed. Members were informed the Clegg Cup would be played on a league basis as from 1995 with Ponteland in Division 1.



**Men's President's Day, 1994**

- Back Row (l - r) :** G. Warner, G. Skinner, W. Bell, G. Goldie, M.A. Bennett, P. Cordingley, S.A. Swift, J. Lunn, J. English, J.S. Varley, A. Turner, Mesdames J. Cosby, M. Lowthian and M. Bryson, E.W. Lowthian, Mesdames E. Newton, M. Healy and D. Lumley, J. Wood, ? , Mrs G. Jordan, R. Lyon, Mesdames E. Walters, M.E.H. Nesbit and F. McDonald, P. Telfer, Mrs B. Grieve, ? , Mesdames M. Cassie and M. Williamson, N. French, Mrs V. Lonsdale, ? , Mrs L. Barrons, H. Robson, Mesdames E. Younger, E. Emmerson and M. Tailford, G.M. Wilcock, G.D. Bennett, Mesdames D. Johnson, N.F. Orton, T. Wright and W.O. Carse, S. Vine
- Front Row (l - r) :** J.W. Nesbit, Mesdames D. Crofts, F. Jeffs and M. Little, F. Knight, M. Edison, R. Stafford (President), Mesdames B. Stafford, L. Telfer and J. Nichol, L. Crofts, Mesdames M. Myers, A. Gill and E. French, G. Bowmer, T. Lumley, G.H. McDonald, R.I. Shuttleworth and C. Walters

At the 1995 AGM, attended by 45 members, the Treasurer circulated a paper showing an estimated positive cash position of £6,600 at the end of December. It was agreed that in order to meet the needs of an increasing membership, a new Pavilion was needed. It was decided that J.T. Harrison together with his Committee be asked to prepare a case for receiving financial aid from the National Lottery Commission (NLC). In connection with the bowling green, it was agreed, in principle, to install an automatic watering system at an approximate cost of £6,000. This would be implemented soon after the Pavilion project was completed. During the period 1970 - 1994, subscription-free Honorary Life Membership had been awarded to fifteen

members in recognition of services to PBC. Presumably, for financial reasons, it was decided that any future award would be made as an Honorary Vice President. Members agreed with the President that another honours board should be made available to recognize Honorary Life Membership.

Following their success in winning the British Isles Pairs Championship in Llanelli, Keith Wood and Michael Bennett were selected in February 1996 as Northumberland's "Sportsmen of the Year". They attended with invited guests, a presentation in Morpeth arranged by the Northumberland County Council.

At the 1996 Spring General Meeting the Treasurer reported a balance of £7,034 in the General be increased by 10% to £55. Members agreed that the annual subscription for both Associate and Junior members be raised to £14 and locker fees to £3. Also, both visitors and CIU competition fees were raised to £2 per person. On the subject of the proposed Pavilion project, J.T. Harrison reported on the latest position in connection with his submission to the NLC.

Regarding the possible recruitment of Junior members, R.I. Shuttleworth reported on a proposal for a Youth Policy in connection with the local schools which was approved by the members.

At the 1996 AGM it was decided that the Club should implement the drainage recommendations and modified maintenance programme given in the report by the Sports Research Institute of Bingley. The green had been partly waterlogged, following heavy rain early in the season, causing the cancellation of some fixtures. At the meeting, it was agreed that a working party be set up, comprised of GPC members from both Sections, to recommend at a General meeting of the Men's Section, outline details for the integration of the Ladies' and Men's Sections. This would be a pre-requisite for a successful NLC award.

Further to this, J.T. Harrison stated it had been brought to his attention by the PMH Secretary, that the Trust Deed categorically states that membership of PBC is strictly limited to persons residing within 3.5 miles of PMH. He also stated that when the necessary amendment to the original submission for financial assistance had been made, it was his intention to resign from the project. Later on, however, in view of the envisaged increasing Pavilion project costs, and possible lack of support in connection with equal membership rights, the GPC withdrew its application to the NLC.

In 1997, the Club held a joint pre-season dinner in the Wheatsheaf Hotel, Woolsington. At the 1997 Spring meeting the Treasurer reported a balance of £8,984 in the General Account. Members were informed of the increased expenditure by the Club in carrying out further work to improve the drainage of the green, the provision of a new watering system, and the need to upgrade the kitchen. It was agreed that an increase in the annual subscription from £55 to £60 was necessary to help fund these improvements. Associate and Junior subscriptions were raised to £15 with new members paying an admission fee of £60. The GPC authorized an increase in the honoraria for the Pavilion Building Manager, the Green Ranger and his assistant.

At the 1997 AGM the President-elect, A.M. Maclean, on presenting his tenth and final report as Secretary, thanked members for their support which was reciprocated in turn by the members. Members were informed that the Ladies' Section would contribute 37.5% (£4,650) towards the heavy expenditure incurred in 1997 on green maintenance and Pavilion repairs. The proposed amendments by the GPC to the Club Rules were approved but with the exception of the Rule relating to the 3.5 mile residential limit incorporated in the PMH Trust Deed. Following the election of Officers and Committee members, it was agreed that Past President, E. Scholes, be made an Honorary Vice President in recognition of services to the Club. In connection with PBC coaching activities, W.R. Liddle agreed to team up with the Club Coach, R.I. Shuttleworth, and

assist with the helpful induction courses.

In 1998, PBC celebrated its 75th Anniversary with a pre-season dinner in the Wheatsheaf Hotel, Woolsington. A Gala Day to mark the occasion was held on the 1st August and a tree was planted in the southern surrounds of the bowling green with a commemorative plaque.



(l - r) : Marjorie Duff, Thelma Wright, Kathleen Armstrong and Cecil Nicholson



(l - r) : E.W. Lowthian, S.A. Swift, Mesdames W.O. Carse, E. Emerson and ? ,  
N. French, Mrs E. Younger, J. Lunn, P. Telfer, J.S. Varley, Mesdames  
M.E.H. Nesbit and ?, ?

Extremes in Ponteland Weather, 1995

At the 1998 Spring meeting the Treasurer reported a balance of £7,767 in the General Account. The annual subscription of members and the admission fee for new members were both increased by £3 to £63. It was also reported that the Ladies' Section had contributed £3,900 towards the expenses incurred by the Club. Members were informed of the financial problems confronting PMH and agreed to make a donation of £300 towards their overheads. In connection with forthcoming fixtures, it was announced that S.A. Swift had been elected Chairman of the NEEPCL. In 1998, the Club received a third £50 prize from the National Savings Premium Bond Draw since taking out the £100 Premium Bond in 1983. It has proved to be an excellent tax-free investment for the Club.

At the 1998 AGM, attended by 40 members, there was a lengthy exchange of views on equal rights for all members in the Club. This would allow the ladies to have a vote at future AGMs. It was finally agreed that the GPC should set up a sub-Committee to decide on the amendments required to the Constitution removing all reference to gender. A proposal was brought before, and approved at an EGM, held on the 25th March 1999, granting full membership rights to the Ladies' Section, with effect from the 1st October 1999. Annual elections would be held for the offices of Chairman, Secretary and Treasurer, also for joint membership of the General Purposes, Social, and Green's Committees. These offices could be held for a maximum of three consecutive years. The Chairman would be impartial, and have a casting vote. In other respects, the two Sections were to operate autonomously, as before.

At the 1999 Spring meeting the Treasurer reported a balance of £6,718 in the General Account and that there were sixteen new members. It was agreed that the annual subscription be increased from £63 to £65 in line with inflation. Both H. Robson and W.R. Liddle were congratulated on having qualified as NCBA Coaches. In recognition of services to the Club, it was agreed that A.M. Maclean, the former Secretary and Past President, be made an Honorary Vice President. It was reported that two lady members, Ora Carse and Peggy Myers, had very generously donated six rink-side score stands to the Club. In connection with the fixtures for 2000, it was decided to enter both the Parliamentary and the Nines leagues. During the season members were saddened to learn of the passing of Brian Armstrong whilst playing on the green.

At the 2000 AGM a promising Junior member, T.A.W. Bell, was congratulated on reaching the final of the NCBA Under 18s competition against the eventual winner L. Foo (Benfield B.C.). Also, members were informed that D.T. Edwards had been appointed a National umpire.

At the 2001 Annual General Meeting, attended by 33 members, G. Webb and R.J. Varley reported on the latest situation on the proposed new Clubhouse. With respect to the domestic competitions, it was reported that members from both the Ladies' and Men's Sections had held a successful meeting at the beginning of the season in connection with the arrangements for the mixed competitions. Because of inclement weather the Men's President's Day was abandoned. Members agreed with the suggestion by A.O. Christie that consideration be given to holding a joint Presidents Day in future. Concerning the league fixtures, there was concern at the shortage of players for the NEEPCL matches. For the first time, white dress was worn in the Finals of the Men's domestic competitions. Also, in 2001, H. Robson was appointed

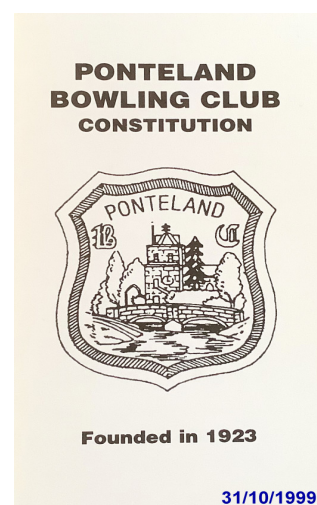

the official County Coach. In order to mark the centenary of the EBA the affiliated Clubs had been requested to donate £10 to the NSPCC charity which met with the agreement of the GPC.

At the 2002 Annual General Meeting, attended by 30 members, concern was expressed by the Secretary, R.A. Peckham, for the Club's future when only a third of the Men's Section were prepared to represent the Club and, more so, with the diminishing number of members who were prepared to take office. He was of the opinion that there was a need for new blood and fresh ideas. Once again there had been a struggle in raising a team for the NEEPCL matches and it was agreed that the Club should no longer participate in this competition. Historically, the Club won the inaugural NEEPCL competition in 1973 and the inaugural NEEPCL Gala Day Trophy competition held in Summerhill B.C. in 1977. A brief review of progress on the Clubhouse project was made by G. Webb and R.J. Varley. It was stated that there were legal difficulties to be overcome and financial constraints.



**President's Day, 1999**

**Ladies Standing (l - r) : M. Little, E. Younger, T. Wright, M. Shuttleworth, M.E.H. Nesbit, G. Liddle, G. Cattliff, N.F. Orton, E. Shuttleworth, M. Williamson, M. Scarlett, M. Healy, C. Cobbing (President), D. Crofts, M. Tailford, M. Bryson, A. Baxter, M. Cassie, F. McDonald, M. Lowthian and M. Myers**

**Ladies Front Row (l - r) : A. Gill, E. French, I. Cassidy, F. Owen and I. Fletcher**

**Men (l - r) : W.R. Liddle, A.M. MacLean, R.I. Shuttleworth, W. Bell, G.D. Bennett, G. Cassidy, M. Edison, G. Bowmer, R.B. Baxter (President), A. Turner, C. Bryson, R. Stafford, E. Scholes, E.W. Lowthian, G. Skinner, G. Warner, J.W. Nesbit, G.H. McDonald, L. Crofts, E. Edwards, R. Elder, S.A. Swift, G. Attwater, A. Harper and T. Lumley**

At the 2003 AGM, attended by 38 members, the Secretary again expressed his concern at the lack of enthusiasm of some members to take part in Club matches and domestic competitions. This became all too evident when the long established Harry Emery Mixed Pairs competition was won by two ladies because of insufficient male members taking part. In future, any participation in long-standing competitions, viz. the Alfred Bell Cup, Edwardson Cup and Northumberland Challenge Cup could be at risk. The Competitions Committee Chairman, F. Knight, stated that overall the results of matches had been variable reflecting the need to recruit both younger and more experienced bowlers to represent the Club. R.A. Peckham stated that he had been



proud to represent the Club for the past three years and was willing to continue as Secretary but understood it was not allowed according to the Constitution. However, during the election of Officers and Committee members no-one had volunteered to replace him, and following considerable discussion, the members agreed that he should continue for another year. In view of this dilemma, J.T. Harrison called for the Constitution to be reviewed, in general, and amended with particular reference to the three-year term for Officers. This was met with much approval by members present. In addition, he requested that should members have any photographs and information relating to the history of the Club that they are included in the blue folder kept in the Store Room. His request prompted the preparation and publication of the Club's history in 2007 and later on, with an extended and revised online version covering the Club's centennial in 2023. The caricature on the front cover of the newly introduced PBC fixtures list in 2004 was a source of amusement but removed from editions in 2018.

At the 2004 AGM, attended by 36 members, A. Wilson had agreed prior to the meeting to act as Secretary for the Men's Section. At the meeting he informed members that it was only a stop-gap appointment until someone else was willing to take over the position. Thanks were expressed to members of the various Committees for their efforts throughout the season. Members were also grateful to the ladies in the Club for their assistance with catering arrangements at several matches. Inclement weather during August had caused re-arrangement of several league fixtures. It was reported that the Green Ranger, R. Stafford, was no longer able to carry out actively all of his duties and Colin Moore had been engaged for some of the work on hand. Members were informed that H. Robson and R.I. Shuttleworth were resigning from their respective positions of County Coach and League Secretary. Later on, W.R. Liddle accepted the position of County Coach in 2005.



At the 2005 AGM, attended by 36 members, A. Wilson presented his final report as Secretary. He said that the Committee and various sub-Committees had met regularly ensuring that events moved smoothly, especially those organised by the Social Committee. Also, he requested that more members be prepared to assist with the administration of activities in the Men's Section. In general, the weather permitted both friendly and league fixtures and also the domestic competitions to be completed with a minimum of re-arrangements. In view of the continuing decline in the results of both friendly and league matches, the GPC had agreed to the suggestion that priority be given on the Waiting List for recruiting two experienced bowlers. Also, it was announced that R.I. Shuttleworth had tendered his resignation from coaching activities at the Club. His efforts on behalf of new members, in particular, were much appreciated. Also, it is a pleasure to record in January 2006 the centenary of a popular former member, G.C. Nicholson, who had retired from bowling following his 90<sup>th</sup> birthday.

At the 2006 AGM, attended by 30 members, T.N. Robson on reporting of his first year as Secretary stated that the Club did not have much success in the league fixtures. G. Webb, Chairman of the Selection Committee, expressed his concern at the unsatisfactory league results primarily due to the continual decline of talent, the age and illness of some members. Also, other promising members were reluctant to participate in competitive matches. Notwithstanding, the friendly matches and social events had been enjoyable occasions. The Club successfully hosted the Jubilee Cup Final, the J.M. Oubridge Cup Final and the PBC v. NCBA President, D.W. Kirk, and his

Select Team. Subsequently, both the NCBA and Portland Bowling Green Club thanked the Club for organising these fixtures. During the election of Officers and Committee members, approval was given to a new member, the County President, D.W. Kirk, who requested nomination by the Club in order to continue as the NCBA League Secretary. During the 2006 season three young promising bowlers had joined the Club as Junior members and received coaching from H. Robson who was accompanied by the Secretary. Members were advised to contact W.R. Liddle should they be interested in qualifying as Club coaches and to attend the English Bowls Coaching Society (Northumberland) scheme of 5- 7 weeks duration.

At the 2007 AGM, attended by 27 members, the Secretary thanked members of the various Committees for their efforts in the successful running of both league and friendly matches. The league results were impressive with three teams being promoted. Also, it was surprising to find that with the indifferent summer weather only three matches were re-arranged due to rain. It is a pleasure to record that visiting teams have again congratulated the Club on the condition of the bowling green and its surrounds. Much of the credit belongs to the volunteer members of the Green's Committee and to R. Stafford, the Green Ranger, who in recent years regularly supplied the bedding plants. Following his retirement for health reasons after eighteen years at the Club, D.W. Kirk agreed to take over the position of Green Ranger. The Club was thanked for successfully hosting the NCBA and Portland Bowling Green Club matches. The catering arrangements provided by the ladies for these fixtures were much appreciated. The domestic competitions were discussed and it was agreed that the maximum handicap be set at +6. The President, R.J. Varley, remarked on the unusual absence of a men's Triples competition at the Club. He suggested that the 4-Bowl Over 60s Handicap be changed to a 3-Bowl Handicap competition which met with unanimous agreement.

The Chairman, A.O. Christie, then drew attention to the recent publication on the Club's history. He stated that 50 of the 100 copies printed had been purchased by members and that another 32 copies had been sold to others outside but with links to the Club. He described it as '*A tremendous piece of work and a wonderful history of the Club for which Bernard is to be congratulated.*'

The last Spring meeting was held in 1999 and B.D.W. Wright enquired whether they should be held again to inform members on matters raised at GPC meetings held during the winter viz. forthcoming social events, forthcoming fixtures and matters of interest raised at the NCBA AGM. Although the Ladies' Section continues to hold Spring meetings little interest was shown by the members present to re-instate their Spring meeting. Although members of the Men's Section are mostly retired no interest was shown either in the suggestion that their meetings be held during the afternoon rather than in the evening, as is the case with the Ladies' Section.

At the 2008 AGM, attended by 36 members, the retiring Secretary, T.N. Robson, referred to the very poor weather during the season and the need to re-arrange fixtures. He expressed thanks to the ladies for providing the meal for the County match against Cumbria which had been played in terrible conditions. The inclement weather led to the cancellation of President's Day and the twice rain-affected Pairs competition. Due to the problems experienced in getting sufficient members to participate in friendly matches it was agreed that fixtures against Amble, Alnwick and Lyndhurst be reduced to one per season alternating home and away. In addition, it was decided that matches against Northumberland Police, Ryton Veterans and the Mayor be discontinued.

In connection with the proposed Clubhouse extension, more details were provided by the Treasurer, J.T. Harrison. He then thanked the other six Committee members who had acted as guarantors for the £10,000 loan from Bowls England and for their help in realising the project. It was hoped that planning permission would be received by the end of the year and that the extension would be completed in March 2009. The second phase of the project was to clear the waste land at the south west

corner beside the footpath and Darras Road. This would provide the space necessary for a patio and paved area for social functions. The two projects are discussed further in Sections 7 and 8. The retiring President, R.J. Varley, openly thanked the Treasurer for his achievements in obtaining the required grant-aid from the local authorities and the Bowls England loan in order to take the Clubhouse project forward. Also, he congratulated him on enabling members to enjoy much improved facilities without imposing any direct financial burden on the Club. The newly elected President, A. Wilson, thanked the retiring Secretary, the Treasurer and D.W. Kirk for their efforts during the year. Also, he expressed regret that, owing to health considerations, F. Knight was unable to take up the position of President.

At the 2009 AGM, attended by 30 members, the Secretary reported that weather wise the league fixtures had progressed well but some friendly matches were affected. The visit by the Bowls England President's touring team had been very successful. The catering arrangements provided by the ladies for this fixture was much appreciated. The innovative Taster Sessions open to the public to attract new bowlers had gone well and would be repeated in future. Coaching sessions with youngsters from the Ponteland Youth Centre had also been successful. E.W. Lowthian reported that the domestic competitions had been completed successfully although R.J. Varley was disappointed with the lack of names available for both league and friendly matches, also members' late withdrawals from fixtures.

The President, H. Robson, thanked the Treasurer, J.T. Harrison, for his report on the successful completion of the planned Clubhouse extension and external site work. The equipment shed had been re-located and a patio area constructed, with the finishing touch being a pebbled area at the rear of the Clubhouse. The bequest of £500 in memory of John English was used to establish a memorial garden at the end of the patio. A memorial plaque made by R.I. Shuttleworth would be mounted on a hardwood plinth.

Concerning league matches, the President displayed an all-white polo unisex shirt with a Club badge and optional personal name which the GPC were recommending to be worn for Clegg, Knight and Nines matches in 2010. Members agreed with the proposed dress and also agreed with the proposal by H. Howell that these shirts be worn in the Parliamentary league matches. In connection with domestic competitions, R.J. Varley proposed that winners and runners-up of the two handicap competitions have their handicaps reduced. Following much discussion, it was decided that the two major Singles competitions should also be included. The following amended proposal was agreed by the members :

*"The winners and runners-up in each of the four Singles competitions would in the following year have their handicaps in the two handicap competitions reduced by two shots, the runners-up to have their handicap reduced by one shot and that these reductions to apply for a two-year period."*

Members were informed that J.D. Cowings and Mrs M.E.H. Nesbit were qualified coaches but more were required if the Club is to pursue its ambition of working with local schools. Mention was made of the coaching course to be held in West Denton in January 2010. Following his term as President, Harry Robson and his wife, Margaret, provided finance to replace the Club's wrought iron entrance gateway.

At the 2010 AGM, attended by 33 members, the Secretary stated that some matches had been postponed because Clubs had been unable to field a team for other reasons than bad weather. The league results were disappointing but in the Northumberland Challenge Cup a place in the final was lost by one shot. The highlight of the season was winning the Jubilee Cup for the first time. Also, following two very successful Taster Sessions, open to the public, the Club was able to welcome several new members. As in the past, working with the local school has had little reward. E.W.

Lowthian reported that the domestic competitions had been completed successfully. M.L. Brennan was disappointed with the lack of names available for both league and friendly matches which was compounded by late withdrawals of some members from fixtures. In connection with the wearing of polo shirts in league matches, some disquiet and confusion had occurred with some members wearing them in friendly matches. Following a somewhat lively discussion, it was agreed that members would attend friendly matches wearing the usual dress code of white shirt, Club tie and blazer. J.D. Cowings reported that there were six qualified coaches in the Club who had met to plan activities for 2011. It was agreed that the Club should enter one rink in the Parliamentary League Ringtons Cup competition. During the election of Officers and Committee members, the President, M. McDonnell, thanked everyone for their support during the season. He mentioned, in particular, Committee members, event organisers and others who had taken part in the Club's activities. He considered the bowling green to be in excellent condition and spoke of both the bowling and Tennis Club's success in being jointly awarded a Silver Gilt Medal Certificate in the "Northumbria In Bloom" competition at the first attempt. Also, he warmly congratulated R.J. Varley on being the runner-up in the centennial year of the J.M. Oubridge Cup competition. He then presented the winning rink with the Jubilee Cup and their individual plaques. Following on from the elections, members were requested to consider seriously taking on some official positions within the Club.

At the 2011 AGM, attended by 33 members, the Secretary reported that owing to the unusual inclement weather towards the end of the season several matches were postponed. He mentioned very satisfactory results in the league and friendly matches and excellent performances in both the Alfred Bell Cup and Northumberland Challenge Cup competitions. Highlights of the season were the individual performances of both R.J. Varley in winning the County "Champion of Champions" Deuchar Cup and of D.C. Crozier, the runner-up in the J.M. Oubridge Cup competition. Four very successful early season Taster Sessions were staged as part of the Bowls Development Alliance. Attempts to work with the local school again proved to be unrewarded. Finally, on completing his three years as Secretary, D.W. Kirk, thanked the members and ladies who had given him their full support and A. Ridley for his excellent work on the website. A.O. Christie reported that the domestic competitions had been completed successfully but only eight entries were received for the Pairs competition. He was also disappointed

to find that male members were not very supportive of the mixed competitions. J.D. Cowings mentioned the recurring problem of members unwilling to make themselves available for selection in matches. The retiring President, J.D. Cowings, reported that a six-week programme on coaching activities for several ladies and male members had been organised. A video camera was available now enabling members to study individual bowling actions. Members were advised that their views would be requested at the 2011 Combined AGM when a proposal by the Treasurer, endorsed by the GPC, regarding the entrance fee for new members would be discussed. The meeting was then informed of the passing sadly of a very



Centenarian Cecil Nicholson popular past member, Cecil Nicholson, aged 105, in October 2011. In Issue 5, February 2006, of the Pont News & Views magazine a snapshot of his life and work in his family food wholesale business is summarised. Clearly, a very happily married man when stating 'The secret to a good life is a good wife'.

At the 2012 AGM, attended by 32 members, the Secretary, D.W. Morrison, stated that variable weather conditions similar to 2011, had affected league fixtures. and in particular, both the Clegg and Parliamentary matches. Notwithstanding, the re-arranged fixtures were completed on time. From the results point of view, the Nines team were relegated to Division 2, mainly due to losing some matches on the last end.

On the other hand the Knight team finished second and were promoted to Division 3 after an absence of three years. Also, PBC won the Public Utilities League Division 2 title and were promoted to Division 1. The recent introduction of Taster Sessions, which are open to the general public, were again well supported. The five sessions resulted in several ladies and men joining the Club.

In connection with the domestic competitions, R. J. Varley said '*There was a mad rush to complete the four main competitions in time for Finals Day in mid - August.*' Although the weather was indifferent, the day itself was a success and would be held in future. The perennial problem of men not participating in mixed fixtures and competitions was somewhat disappointing. A similar problem had confronted the Selection Committee and J.D. Cowings asked that more members make an effort to be available for both league and friendly fixtures. Thanks were extended to the Committee members for their efforts throughout the season. A lengthy discussion ensued on the number of friendly fixtures and the apparent lack of support by members. The President, D.W. Kirk, also expressed concern at the lack of enthusiasm of members to participate in both friendly and league fixtures and requested more support for next season. Otherwise, consideration may be given to reducing further the number of friendly fixtures to those previously agreed at the 2008 AGM.

With regard to coaching and development, J.D. Cowings stated that the Taster Sessions would be repeated next season. For the benefit of new members, it is intended to have monitors in the Club who would regularly inform new members of social events and encourage their participation in matches. Unfortunately, during the season no coaching sessions were arranged but it is planned to organise several days in 2013. The President stated that a proposal would be put forward to the Combined AGM recommending the entrance fee for new members remain at zero. The Treasurer then explained why it would be necessary to raise the annual subscription from £80 to £90 next year. Members indicated their support for the increase with a show of hands.

Considering Club fixtures for 2013, the members agreed to enter the same competitions as last season. The President informed members of a proposal by the GPC to reduce the four domestic mixed competitions to one. Details of the outcome are given in Section 1.3.

Following the election of Officers and Committee members, it was suggested that a travelling reserve be available for league matches. Members decided that this idea be considered again at the next meeting. Further to the decision taken at the 2007 AGM not to resume Spring meetings and which were last held in 1999, the matter was raised again. Following some discussion it was agreed that a Spring meeting would be held in 2013.

At the 2013 Spring meeting, attended by 22 members, President D. Franks said '*Following the recent death of a member and after a great deal of deliberation the GPC had taken the decision that no longer would relatives be allowed to spread the ashes of deceased members around the surrounds of the bowling green.*' The Secretary then outlined the Club programme for the forthcoming season.

The President requested that more male members make themselves available for friendly and league matches. To assist the Selection Committee a form will be displayed on the men's notice board for members to sign should they wish to participate in friendly matches. When teams are selected members will be required to add their signature confirming their availability to play.

The Treasurer reported a balance of £19,300 which included the receipt of recent membership subscriptions. He stated that the intended early repayment of the remaining £4,000 loan to Bowls England would result in a £600 rebate.

The Club Secretary reported on progress made on achieving the Bowls England Club Mark Accreditation and hoped that the Club would achieve this status by the end of the year. When achieved, the Club would be eligible for other grants similar to that requested from the BDA. If the BDA grant was approved it would be used to purchase an aerator for the green being an essential piece of equipment.

Members were informed that the 90<sup>th</sup> Anniversary fancy dress celebrations will take place on Joint President's Day, the 29<sup>th</sup> June. By the end of the bowling season a winter programme would be available informing members of other activities in the Clubhouse during the closed season.

Concerning the Club's website A. Ridley intended to provide more information including the dates of Taster Sessions. He intended to display some photographs from 1923 onwards on Closing Day and would welcome other photographs from members. At the end of the meeting R.J. Varley volunteered to have the Club's badge printed onto members' new Club shirts. Ten vacant lockers were available now for any members requiring one.

At the 2013 AGM, attended by 22 members, the Secretary, D.W Morrison, stated that it had been an excellent season with very good weather and even better results with promotions in both the Nines and the Knight competitions.. However, the results from the cup competitions were disappointing, particularly when narrowly losing in the Jubilee Cup final. The Secretary thanked the Green Ranger, W.R. Liddle, for his maintenance of the green. It should be noted that in 2013, the home programme included a total of 124 fixtures, excluding members' participation in individual domestic competitions.

R.J. Varley commented on the perennial problem of completing the domestic competitions in good time for Men's Finals Day. It is a pleasure to record the achievement of the Secretary, D.W. Morrison, having participating in the finals of the four main Singles competitions, winning three and narrowly losing in the fourth. The Secretary stated that team selection had proved difficult at times as members' availability lists were not kept up to date. The league results, however, showed that the Selection Committee had performed commendably. The President referred to the lack of support from male members for both friendly and league matches and asked that they should give some thought to making themselves available next season for these matches.

On coaching and development J.D. Cowings reported that the Taster Sessions went well and would be repeated again next year. When Bowls England Club Mark status is achieved the Club will be the first in Northumberland to receive this award. It is intended to organise a number of days for coaching sessions next year. The Club's Development Plan was published in April 2013 and also the Bowls England Club Mark Accreditation equity policy statement.

The President commented on the sound financial situation of the Club with nearly £2,000 of grants being awarded. The members agreed that the joining fee should remain at zero and retain the membership subscription at £90. Regarding competitions, it was agreed that the Club enter the same as those in 2013.

Following the annual election of Officers and Committee members, W.R. Liddle requested help over the winter period. The green would need swishing to remove dew and reduce the possibility of any diseases. It would take only 30 - 40 minutes effort but not to be undertaken in frosty conditions.

At the 2014 Spring meeting, attended by 21 members, the Secretary stated that the response of members to the request for more members to participate in the various league competitions was disappointingly low. Only 32 members were prepared to play

in more than one league compared with 63 last year. An additional 19 extra matches would be played which included an extra team in both the mixed Public Utilities League and mixed friendly fixture with Prudhoe.

The Treasurer, J.T. Harrison, reported on the Club's healthy financial position although 17 members had resigned from the Club. In connection with the green £7,000 has been spent on new equipment. Grant applications have been made for the purchase of a slotter, seeder and wheeled feeder.

J.D. Cowings extended congratulations to the Club in being the only outdoor Club in Northumberland to achieve Bowls England Club Mark status. Full Club Mark Accreditation would be achieved when younger members joined the Club being a requisite for this award. The following seven qualified Club Coaches were listed on the Development Board for members wishing private coaching :

Mesdames M.E Nesbit & S.A. Storey, M. Brennan,  
J.D. Cowings, D.W. Kirk, W.R. Liddle and D.W. Morrison.

Four Taster Sessions, to encourage recruitment of new members, will take place every Saturday morning in May. Also, a number of coaching sessions, after the earlier sessions, still to be arranged. Four sessions with several children from a local school have been arranged and will take place every Friday at 1.30 pm from the 16<sup>th</sup> May.

Regarding the website set up by A. Ridley, and managed admirably by him for over seven years, he felt it was time for someone to shadow him with the intention of taking over from him in 2015. Meanwhile, a new website with extra features has been set up by P. Kilmister and Miss J. Barras. Sadly, Alan Ridley passed away in July 2015.

At the 2014 Annual General Meeting, attended by 25 members, the Secretary, D.W. Morrison, considered it had been a good season with both good weather and results in the various league matches. He stated that although there were six Taster Sessions held this year there were less newcomers to the Club. Thanks were extended to the Green Ranger, W.R. Liddle, for his efforts in carrying out early repairs to the damaged areas ensuring the green played well. M.L. Brennan reported all competitions had been completed leading to a successful Finals Day. The Selection Committee again reported on the problem of members withdrawing from matches after having been selected to play. A majority of members had been selected for a game. With the lack of names being put forward for both friendly and league matches the President, H.Howell, asked that more members support the Club. Following much discussion it was proposed and agreed that in the case of friendly fixtures the Club play each team only once each year on a reciprocal basis instead of the usual home and away fixtures. The three involved were Gosforth West Avenue, Hexham Elvaston and Portland Bowling Green Club.

In connection with the domestic competition, the Angora Cup will in future come under the aegis of the Competitions Committee but will continue to be organised by P. Telfer. Thanks were extended to those members who had assisted with the Taster Sessions on the green and those providing refreshments in the Clubhouse. It was proposed to continue with the coaching of local schoolchildren on four Friday afternoons in May 2015.

At the 2015 AGM, attended by 25 members, the Secretary, A. Barratt, reported that overall it had not been a very good season for the teams participating in the league fixtures and cup competitions. A total of nine school visits and "Bowls for Fun" sessions had been held during the season. The Green Ranger, W.R. Liddle, was thanked for the excellent condition of the green throughout the season. Mention was made of the repair work to be undertaken on the two end rinks alongside both the PMH and the tennis courts during the closed season.

In connection with the domestic cup competitions, D.W Kirk reported that Finals Day was a success albeit there was again difficulty in getting members' matches completed on time. Some changes were agreed to regarding the Straughan Salver and Angora Cup competitions. On Closing Day there was a total of nine awards to be made at the annual presentation but it was disappointing to find that only four members were in attendance to receive their trophies. Members were asked for their ideas regarding Club Handicaps as there are no written rules.

R.J. Varley reported on the perennial problems with team selection, particularly when members have not indicated their non-availability on the team sheets. He indicated that selecting the strongest teams is very subjective and was not always successful. It was hoped that better performances on the green will be seen next year. It was proposed and adopted that the Club play each team only once each year on a reciprocal basis in both the men's and mixed friendly matches instead of the usual home and away fixtures.

It was reported that in 2015 the men's membership fell by six although attracting four newcomers. Now, that there are a number of strategies in place to attract new members it is still difficult to recruit newcomers and, at present, both family and personal contact appears to be the best way forward.

It was agreed to participate in the same competitions as last year. Following some discussion there was very little support for the proposed New Mixed League to be played on Sunday mornings. A proposal by J. Taylor for the Club to enter the Double Fours National competition did not receive the necessary members' support. It was agreed that players and markers for the Club's domestic competitions should wear grey trousers and whites above the waist instead of casual dress.

It was decided that the Men's Committee meetings should be re-instated after an absence of 2 to 3 years. Also, an informal Spring meeting to be arranged sometime in March 2016. A plea was made for more volunteers and helpers to assist in the running of the Club.

At the 2016 AGM, attended by 31 members, the Secretary, J. Taylor, reported on a very good season in the league competitions. Two teams were promoted - the Nines team were unbeaten and promoted to Division 1, also the Knight team to Division 3. Both the Clegg and Parliamentary teams just missed promotion. H. Howell reported on the domestic competitions the results of which are presented in Section 11. Generally speaking, team selections had gone well apart from an occasional problem with the two Knight teams.

After some discussion it was agreed to adopt a Club shirt for BN league matches commencing in 2017 following the offer of a £500 sponsorship by Landmark Support Services Ltd. Also, it was agreed to participate in the same competitions and friendly fixtures as last year. Members were informed of the proposal by the GPC of a small increase in the annual subscription to be confirmed at the forthcoming Combined AGM.

At the 2017 AGM, attended by 25 members, the Secretary, J. Taylor, reported on the up and down season of league results. The Clegg team had been promoted to Division 1 and the other teams retained their league status. The Club lost their semi-final of the Edwardson Cup to Backworth the eventual winners. The Club were losing finalists to Benfield in the Jubilee Cup but were winners of the Presidents' Cup Final against Benfield. The worst moment of the season was not being able to raise a team for the Knight Division 3 fixture against Walker.

H.Howell requested members participating in domestic competitions to arrange their matches earlier to ensure their completion dates. The handicap system



was discussed and new bowlers in the Club would be assessed more on their ability. Two friendly fixtures were cancelled due to lack of numbers and future matches would comprise of rinks of triples instead of fours.

The 2018 AGM was attended by 16 members - a very disappointing turnout for these meetings. Following J. Taylor's resignation from the Club, D.W. Kirk had taken on the secretarial role on a temporary basis. Overall, the results for the league matches were reasonable but some disappointment with the Clegg team being relegated to Division 2. The mixed Public Utilities team finished second in Division 1. The friendly fixtures were completed with the exception of Hexham Elvaston who were unable to raise a team. The GPC has decided to review the method of selection of teams for future friendly fixtures. The early season Taster Sessions were very successful with the arrival of new members, 6 men and 4 ladies. The Secretary expressed his dismay at the lack of members' commitment there being no nomination received for Vice President in 2019. However, during the election of Officers and Committee members the position was taken up by R.J. Varley. Regular monthly section meetings with appropriate reporting had been re-established. The Secretary thanked everyone for their help during the year particularly from the President and Committee members. In connection with the men's domestic competitions, H. Howell reported there had been a significant reduction in entries but the matches had been completed in a timely manner. The Finals Day was a success and thanks were extended to members of the sub-Committee for their support.

In order to assist the Selection Committee D. Cowings appealed for more men to commit themselves for selection in both league and friendly matches. Statistics have been compiled throughout the season which indicated that although there were unexpected withdrawals from some matches a high percentage of the players selected actually played. Thanks were extended to the Committee members for their hard work throughout the season. D.C. Crozier reported that selection for the Public Utilities mixed teams had worked well. D.W. Kirk asked those present at the meeting to inform other members of the need to making themselves available for league and friendly matches.

On the subject of Coaching and Development the Head Coach, W.R. Liddle, reported several members had received extra coaching sessions on delivering bowls which were mostly attended by the ladies. It is hoped that additional coaching sessions on other aspects of the game can be arranged. Anyone found interested in the sport should be encouraged to attend the Taster Sessions.

The Secretary informed members of the proposal going forward to the Club AGM of the need to increase membership fees. Considerable costs will be incurred to partly finance resurfacing of the PMH car park in the next ten years. Following the election of Officers and Committee members the Secretary reminded the meeting about the winter programme of events including the monthly coffee mornings and asked for their support.

The 2019 AGM was attended by 16 members - a repeat of the very disappointing turnout in 2018. Following an explanation from Past President, A.O. Christie, the meeting wished President, P.A. Dodds, a speedy recovery from surgery in hospital that day. In the absence of the Men's Secretary, W.R. Liddle, his report was read out by the Club Secretary, D.W. Kirk. It dealt mainly with the cancellation of friendly fixtures and the eventual completion of league fixtures due to inclement weather throughout the season. In view of past difficulties in playing Hexham he proposed removal of this friendly fixture. Mention was made of the recruitment of members making good the loss in recent years. However, no nomination had been received for the vital role of Men's Secretary which could have a bearing on the future of the Men's Section.

Regarding the domestic competitions, G. Lord reported that they had generally gone to plan. However, some difficulty was mentioned in completing some finals due to severe duplication of finalists. Finals Day was mentioned and the need to make this

more of an event particularly in the case of the Club championship it being the premier competition. He congratulated R. J. Varley on winning the Welsh Memorial Cup and the J. M. Oubridge Cup held at Portland Bowling Green Club for the champions of private clubs.



**Members participating in BN League Competitions, 2017**

**Back Row (l-r) : R.J. Varley, W.R. Liddle, H. Howell, J.T. Harrison, D.W. Kirk, D. Franks, B. Lumbsden, M. Brennan, J. Taylor, K. Preston, R. Pearson and P. Dodds**

**Front Row (l-r) : J. Roberts, A.O. Christie, D.G. Kennerley, W. Howard, D.C. Crozier, J. Gatenby, D.W. Morrison, D. Thompson, M. Anderson, R. Horsfall and P. Telfer**

Concerning Selection Committee activities D. Cowings reported on a difficult season having to rearrange fixtures and extra Nines matches. Using the Availability sheet system had worked well in fulfilling fixtures in the Clegg Cup, Nines and Knight competitions. In the case of the Parliamentary and friendly fixtures the aim was to try and ensure that other members received the opportunity to participate in these matches. J.D. Cowings extended his thanks to members of the sub-Committee for both their work and support. Members were reminded of the need to enter their names in the Availability Book on the men's notice board. D.W. Kirk reported that the GPC had set up a working group to explore the coaching and development of both new and existing members. It would also study methods of recruitment and retention of members and report back by February 2020. Several members present offered to help the working group. D.W. Kirk informed members that a proposal would be going to the Combined AGM to keep fees at their current level. Members agreed to enter the same competitions as in 2019.

At the election of Officers and Committee members the newly installed President, R.J. Varley, thanked P.A. Dodds for his excellent work during 2019. He then confirmed D. Redhead, in his absence, as Vice President. Despite the appeal to members for the vacant position of Men's Secretary it was left unfilled. Following the election of Officers and Committees members the absence of the usual Burns' Night event from the winter programme was discussed. A lengthy discussion then took place regarding the future of Finals Day in an attempt to avoid duplication of finalists. The William Wilson Memorial Men's Pairs competition had not taken place for several years

but was held this season. It was agreed it should continue being a good competition but possibly changing to a handicap format. The suggestion to improve attendance at the men's AGM by moving the time from an evening was discussed but it was agreed the timing should be left to the GPC..

D.W. Kirk informed members of necessary changes and work that will take place shortly at PMH. The building was opened in December 1922 and extended in 1969. Of particular concern to the Club is the proposed introduction of parking charges to cover the high cost of renovation and future maintenance of the car park. The GPC has formed a sub-group to examine any proposals brought to the Club by P. Kilmister, presently a member of the PMH Committee.

The 2020 programme of fixtures, social events and annual members' meetings were cancelled due to the outbreak of the extremely contagious Coronavirus (Covid-19).

The 2021 AGM was attended by a lowly 13 members. Although an extremely disappointing turnout it was not unexpected in view of possibly the more elderly members' concerns regarding Covid-19. Concerning domestic competitions, Finals Day was held in fine weather and thanks were extended to those organising the event and particularly to the ladies for providing the tea. Mention was made of the long-established W. Milne 4-Bowl Handicap and the more recent John English 3-Bowl Handicap competitions not having runner-up trophies. The Competition Chairman, G. Lord, will look at providing suitable trophies for the two competitions. Also, it was pointed out that in a knockout competition both players are responsible for organising their game. An entry fee of £1 for the Straughan Salver competition in 2022 was agreed.

Because of Covid-19 restrictions, external competitions were last held in 2019. A process for selecting teams by the Selection Committee would be agreed later. Sadly, several senior members expressed disappointment with the recent running of the Club's affairs. This led to the loss of several key players to other Clubs. In the light of this incident the members present agreed the Club should participate only in the Knight and Parliamentary matches in 2022. It was reported the last audit of the Club's coaching staff was held in 2013 and now the Club is without any qualified coaches. The GPC, however, consider this should not be a problem with the Club having some experienced bowlers able to assist with coaching of new members.

At the election of Officers and Committee members, former President G. Lord and W. Howard were installed as President and Vice President respectively. The position of Men's Secretary was expected to be confirmed with help from D. Burbeck. A.O. Christie agreed to serve on the Social Committee. The Club Secretary, D. Burbeck, expressed his concern at the Club's difficulties and particularly the lack of support from members of the Men's Section. He drew attention to a document on the subject that would be presented at the forthcoming Combined AGM. It includes offering to provide more suitable competitions for older members and will be available via an e-mail for anyone wishing to receive a copy.

At the 2022 AGM no details were available of attendance. Regarding competitions, the GPC consider there is a need to encourage more of the new members to participate in the Angora Cup and also both the friendly and league matches. An award was presented to a new member, Steve Edwards, on winning the Club championship. Both PBC teams in the Knight Cup and Parliamentary League matches were congratulated having performed very well and winning promotion to Divisions 2 and 1 respectively. The meeting was informed that team selection by its Committee would focus on three main objectives, viz. fulfilling the fixtures, transparency with selection of players and teams also enabling winning teams and groups of players to be kept together. Further, it is necessary to maintain accuracy of details regarding membership and of the need to enter names in the Availability Book on the men's notice board. The following table indicates the decline in membership in recent years but showing signs of significant

improvement post- Covid-19 attributable to the energy and enthusiasm of the GPC and newly elected members.

#### PBC Men's Membership (2001 - 2023)

Year	Full	New	Associate	Social	Junior	TOTAL
2001	91	3	3	-	1	98
2002	104	?	2	-	-	106
2003	97	15	3	-	-	115
2005	83	7	4	-	-	94
2006	97	6	4	-	-3	110
2007	95	6	2	-	-	103
2008	90	5	4	-	-	99
2009	86	2	3	-	-	91
2010	80	3	6	-	-	89
2011	77	5	4	-	-	86
2012	73	6	3	-	-	82
2013	85	?	8	-	-	93
2014	72	?	8	3	-	83
2015	67	?	5	5	2	79
2016	63	-	2	-	-	65
2017	60	?	2	4	1	67
2018	51	6	2	3	-	62
2019	56	?	4	5	-	65
2020	46	?	4	?	-	50
2021	45	?	?	?	-	45
2022	40	18	2	1	-	61
2023	53	13	2	5	-	73

## 1.2 Ladies' Section

On the 15th June, 1967 the newly founded Ladies' Section had twenty members. Prior to this event, many of the ladies had assisted with the Club's social functions including the hosting of NCBA matches but without bowling privileges.

The first AGM was held in PMH on the 27th February, 1968 and attended by 14 members. It was agreed that subscription for playing members should be £1 10s. 0d, for Social members, 15s. 0d and for Juniors (between 14-16 years), 7s. 6d. A fee of £30 was paid to the Men's Section for use of the green. In 1968, the first official friendly matches were arranged with Forest Hall, Parkhouse and Tynemouth although the home game with Parkhouse was cancelled due to bad weather.

At the AGM in October 1968, attended by ten members, it was decided that Whist Drives would be held in the Pavilion during the afternoon throughout the winter months. In 1969, Forest Hall, Tynemouth and Whitley Bay participated in their inaugural friendly matches at Ponteland.

At the AGM in February 1970 it was agreed that invitations be sent out again to Forest Hall, Tynemouth and Whitley Bay Ladies who had played at Ponteland in the previous season. In addition, invitations were sent to the ladies at Alwick, Hexham and Portland. Members were asked to support the annual pre-season coffee morning arranged by the Men's Section. Also, they were reminded they could play during the morning, afternoon, and evening whenever the green was not in use for men's matches and competitions. It was decided that the weekly Jumbles would be played on Tuesday afternoons and that the ladies should hold their own President's Day in May 1970. A

Ladies' Handicap competition was introduced with J. Oliver of the Men's Section awarding the finalists with Contract House vouchers for £2 and £1.

At the 1971 AGM it was agreed that L.H. Loughton be made an Honorary Life Member in recognition of services to the Club which included pre-1967 social activities. A Jumble Sale, held in the Methodist Church Hall, raised £32 of which £20 was donated to the Men's Section to help finance the upkeep of the green. In November 1971, the first Ladies' Annual dinner & Prize Presentation was held in the Bowler Hat, Broadway, Darras Hall.



Ladies' Day, 1961

Standing (l - r) : M. Hetherington, E. Jameson, E. Wood, S. Self, E. Lloyds,  
J. Weightman, ? , L.H. Loughton, ? , ? , ? and J. Hepple  
Front (l - r) : O. Steele, M. Douglas, M. Latham, A.E. Mankin and O.M. Carr

At the 1972 AGM the annual subscription of full members rose to £2. The Ladies' Section had almost £122 in their Accounts most of which was raised from their revenue-raising efforts. The dedication of the Ladies' Section in raising funds for the well-being of the Club has never been in doubt. In particular, reference should be made to their efforts concerning the various Pavilion projects over the years. After expenses, 50% of the proceeds from a Jumble Sale held in the Methodist Church Hall were donated to the Men's Section. In recognition of services to the Club over many years, it was agreed that J. Mole be made an Honorary Life Member. Also, it was decided to introduce an annual knock-out competition with presentations of rose bowls to the finalists. It was also agreed to hold one unit in the PMH "200 Club" Draw. The 1972 Annual dinner and Prize Presentation was held in the Newcastle Airport restaurant, and again in successive years until 1975.

At the 1973 AGM the Treasurer reported the balance in their account had risen to £165. Regarding fixtures, it was agreed to approach Benfield, Burnopfield and Denton Burn for friendly matches. It was also reported that the voluntary efforts of several members in the Ladies' Section to spring-clean the Pavilion before Opening Day were appreciated by the Men's Section. The members also expressed their willingness to assist with the catering for NCBA matches and other special occasions, any profits being retained by the Ladies' Section. Also, in return, the Men's Section invited the ladies to play a Mixed Jumbles on a mid-week afternoon and on Saturday evenings. Later on, they were invited to participate in some of the men's friendly matches.

1974 was a difficult year for Mrs D. Emery, the President and Secretary, having lost her husband, Harry, who, at the same time, held both offices in the Men's Section. At the AGM the Treasurer reported a balance of £221 in the Accounts. The members agreed to increase their annual payment to the Men's Section by £10 to £40. In November 1974, the first official meeting was held between the two Sections in the Club. The primary purpose was to seek the views of interested members in connection with the proposed extension of the Pavilion.

In 1975, albeit with a balance of £253 in their Accounts, the annual subscription was increased from £2 to £4 to cover the additional expenses for coach travel and competition prizes. Three members were elected to serve on a Social Committee. The members were informed of a new Mixed Pairs competition to be held in memory of Harry Emery, the late husband of the Secretary. The Ladies' Section were invited to attend the Annual Prize Presentation for the Men's Section. During the presentations, the finalists in the Harry Emery Mixed Pairs competition were presented with their salvers and miniature wine coolers. The last of a series of Annual dinner and Prize Presentations was held in the Newcastle Airport restaurant.

At the 1976 AGM, attended by 15 members, the Treasurer reported a balance of £160 in the Accounts after donating £225 to the Pavilion Extension Fund and the receipt of £5 from the PMH "200 Club" Draw. The Secretary was congratulated on her presentation of a comprehensive report on the season's events. It was announced a new 4-Bowl Singles competition for a silver rose bowl would be held in memory of the first Lady President, Betty Pascoe. The members agreed with the suggestion from the Men's Secretary for the ladies to wear name badges at their matches. The Opening Day, in April 1976, heralded the first Mixed Jumbles event followed by a faith tea. The Annual dinner and Prize Presentation was held in Quincy's restaurant. The Secretary reported *'The meal was excellent, the only complaint I heard was about the noise, but as this was made by ourselves we couldn't grumble.'*

In 1977, following a Jumble Sale and receipt of a further £50 from the PMH "200 Club" Draw, the Treasurer reported a balance of £306 in the Accounts, an excellent sum for a small membership of twenty. It was decided to increase the annual payment to £75 to help defray some of the expenditure incurred by the Men's Section in re-turfing part of the green. To celebrate the Queen's Silver Jubilee Year in June 1977 E.M. Roper held a revenue-raising Garden Party at her home which was well-attended by members. In future years, she held similar revenue-raising coffee mornings. In September 1977, it was agreed that the Ladies' Section would pay for two of the six rink-side score stands the Men's Secretary was making for the Club. In 1977, the Annual dinner & Prize Presentation was held in the Newcastle Airport Restaurant. A special meeting was called in November 1977 to which B.D.W. Wright, the Men's Secretary, was invited to discuss the most regrettable incident which occurred at the end-of-season coffee morning held in PMH. This matter is reported more fully in Section 1.1. The ladies were re-assured that their Section would be allowed to enjoy the same privileges of membership as the Men's Section.

At the 1978 AGM the Treasurer reported a balance of £370 in the Accounts. The annual subscription rose to £5 and £2.50 for new members. It was decided that, in future, the offices of President, Vice President, Secretary, Assistant Secretary and Treasurer could be held for a maximum of three years. In 1978, the Annual dinner & Prize Presentation was held for the last time in the Newcastle Airport restaurant.

At the 1979 AGM it was decided that half of the £20 liability imposed on twenty members in connection with possible legal costs arising from the Lands Tribunal should be paid out of the £476 available in the Accounts. It was agreed that extra coffee mornings and a weekly raffle should be held during the bowling season to help raise funds for the Ladies' Section.

At the 1980 AGM the Secretary was pleased to report a much friendlier atmosphere in the mixed events at the Club. Also, it was pleasing to see the numerous photographs taken at the social occasions. In connection with the friendly matches, members appreciated having the newly formed Lyndhurst Ladies' B.C. included in their list of fixtures for 1980. The Treasurer reported a balance of £562 in the Accounts. However, due to the rise in the rental for the green imposed by the PMH Committee, the 50% fee normally paid to the Men's Section necessitated an increase in the annual subscription from £5 to £7.50 and, for new members, a 50% rise to £5. It was decided that every member attending the 1980 Annual dinner & Prize Presentation in Ponteland Golf Club should have the cost of their meals subsidized by £2, to be drawn from the Ladies' Section Accounts. It was agreed that a Pairs competition should be held during the season.

At the 1981 AGM the Treasurer reported a balance of £855 in the Accounts. In view of imminent expenditure in the Club the annual subscription was again increased by £2.50 to £10, and increased to £7.50 for new members. Also, it was agreed that in recognition of the duties performed by both the Secretary and the Treasurer that they should receive an honorarium to cover their annual subscription. In connection with the proposed Pavilion extension, the Ladies' Section were prepared to donate £450. Another revenue-raising social event was arranged by M. Duff with an Annual Garden Party, an event she hosted with her husband until 1986. It is worth mentioning again the excellent efforts made by the ladies with their social activities and financial contributions to the Club. The Ladies' Section accepted an invitation to play friendly matches, on separate rinks, during the Men's NEEPCL Sunday fixtures. In August 1981, the ladies held a presentation to celebrate the Golden Wedding Anniversary of Eve and Tom Mills who were the Presidents of their Sections in 1972.

In 1982, there were 30 member in the Ladies' Section. The Treasurer reported a healthy balance of £711 in the Accounts despite extra expenditure incurred in 1981. The members were looking forward to the new season, and using the facilities of the newly extended Pavilion. During the season, members were saddened at the passing of Nan MacLeod whilst playing in a competition on the bowling green. As a mark of respect, competitions were held back for two weeks. With the competitions about to resume, Beatrice Buckley also passed away suddenly and completion of the Ladies' competitions were further delayed. Later, in connection with social activities, it had been decided to hold the Whist Drives, in addition to the usual coffee mornings, in the Pavilion throughout the winter months. Unfortunately, due to insufficient heating in the building the proposed Whist Drives were cancelled and several coffee mornings were held in members' homes. The proceeds from one of the coffee mornings were donated to the "Guide Dogs for the Blind" Fund. In 1982, the Annual dinner & Prize Presentation was held in Ponteland Golf Club.

At the 1983 Spring meeting D. Emery gave notice of her intended resignation from the position of Secretary at the next annual meeting. In the light of this statement two members, L. Barrons and B. Johnston, agreed to act as Assistant Secretaries with help, should it be required, from the Secretary. The Treasurer reported a balance of £1,007 in the Accounts and it was decided to offer a payment of £300 to the Men's Section for use of the facilities at the green. In connection with prizes for the weekly Jumbles competitions, it was decided to offer the choice of a silver spoon or £1 in cash. Also, the overall winner would be presented with the new Nan MacLeod Memorial Salver. Members were informed arrangements had been made to hold a pre-season dance and a Pie & Pea Supper. It was agreed, for reasons of health, that two Past Presidents, F.M. Bird and E. Mills, be made Honorary Life Members and so retain their association with the Club. Sadly, Marjorie Bird passed away just several days' later.

At the 1983 AGM the Treasurer reported a balance of £1,443 in the Accounts. During the election of Officers, L. Barrons became the new Secretary and the newly created position of Match Secretary was accepted by B. Johnston. It was agreed that

the Match Secretary should not have to pay an annual subscription. It was decided that monthly Committee meetings should be held during the playing season. In recognition of services to the Club, it was agreed that E.M. Roper, a long-serving member who had moved out of the area, be made an Honorary Life Member. Members were informed that the Ladies' Section had now been accepted as a member of the EBWA. They were eligible now to play on a Wednesday afternoon in the NCWBA league matches which required three rinks of four players. The members were to be dressed in whites, but no trousers permitted. Members were informed that a Northern Evening League Gala Day had been arranged for Sunday, the 12th August, 1983. It was decided members could use their own transport to away matches, in lieu of expensive coach hire, and car users would be remunerated for petrol costs. It was agreed that the cash prize offered in the weekly Jumbles competitions be increased from £1 to £2. The members also agreed to provide six bowls-collectors for the benefit of the Club. For the first time, the Ladies' competition trophies were presented at the Ladies v. Gents match held in the end of the season. Also, a presentation of a wall clock and a bouquet was made to D. Emery to mark her retirement after sixteen years as Secretary. The 1983 Annual dinner was held again in Ponteland Golf Club.

At the 1984 AGM members were informed that for the Ladies' Section to be legally affiliated to the NCWBA they were all obliged to pay an affiliation fee of £1 to PBC. Referring to the financial situation, a balance of £1,641 was reported by the Treasurer. It was decided to increase the annual subscription from £10 to £12. Also, in future, all members would pay the full subscription with no reduction for new members. In connection with honoraria, it was agreed that the President should have her annual subscription paid for by the Ladies' Section. The competition trophies were again presented at the Ladies v. Gents match.



**President's Day, August 1984**

**(l - r) : L. Barrons, M. Cassie, N.F. Orton, K. Wright, M. Myers (President),  
B. Johnston, J. Graham, M. Duff and M. Stuart**

At the 1985 Spring meeting it was announced that the permitted maximum number of 50 members had been reached and a Waiting List was prepared. The Treasurer reported a balance of £1,948 in the Accounts including £131 raised from a Jumble Sale and £245 from the regular coffee mornings. In addition to the payment of £500 for use of the green, another £500 had been donated to the Men's Section towards the purchasing of a sprinkler system, a new entrance gateway and new scoreboard.



Following the untimely passing of the President, Kathleen Wright, a special Ladies' Management Committee meeting was held on the 26th June 1985. K. Armstrong, the Vice President, was duly elected the Ladies' President. The provision of a memorial for the late Joyce Carmichael and Kathleen Wright was discussed. Later, a new Triples one-day domestic competition was held for the Joyce Carmichael Cup. It was agreed that £50 from their funds should be awarded to M. Little, a long-serving member, to help towards her expenses when, along with both N. Rutherford and J. Graham, she would be representing both Club and NCWBA in the EWBA Finals at Royal Leamington Spa.

At the 1985 AGM new Club Rules governing the Ladies' Section were approved by the attending 33 members. The Treasurer reported a balance of £1,635 in the Accounts. It was decided to arrange a fund-raising evening in aid of the North East Cancer Campaign, associated with the memory of both Joyce Carmichael and Kathleen Wright. The 1985 Annual dinner was held in Ponteland Golf Club.

At a Ladies' Management Committee meeting, held in February 1986, the President, W.O. Carse, was of the opinion that the Ladies' Section, being financially strong and thriving, should in future hold an annual fund-raising event to help those in need. It was decided to hold a Domino Drive for the local charity PADAC in 1986. It was reported that the Committee had sent a letter congratulating E. French on her recent M.B.E. award for Services to Education. At a later Committee meeting the Treasurer reported £425 had been donated to the North of England Cancer Research Campaign following a very successful Domino Drive event. The regular coffee mornings raised £273.

At the 1986 AGM reference was made to the very successful hosting of the NCWBA match against Yorkshire and the Joyce Carmichael Triples competition. Also, M. Duff was thanked for her most successful Garden Party. In connection with league fixtures, the closure of the Northern Evening League was reported and that Ponteland Ladies had finished second in their NEEPCL Sunday matches. It was agreed that the Ladies v. Gents match held at the end of the season should be the occasion for their Annual Prize Presentation.

Regarding the wearing of a uniform for matches, it was agreed that dress should be all-whites for matches played throughout the months of June, July and August, and grey skirts worn for the other months. Members were reminded to avoid bumping their bowls on the green. If necessary, two County players, J. Graham and I. Fletcher, would be willing to assist those needing to improve their bowling action. It was decided to arrange coaching sessions during the first month of the new season. The 1986 Annual dinner was held again in Ponteland Golf Club.

At the 1987 Spring meeting the Treasurer reported a balance of £1,854 in the Accounts and that the social events had been very successful. In particular, the Domino Drive with its Fish & Chip Supper which raised £425 for PADAC, a local medical charity. In connection with domestic competitions, the members were informed that J.W. Nesbit, President of the Men's Section, had provided a trophy for presentation to the winners of a Mixed Pairs competition. It was agreed that the participants in the National Finals at Royal Leamington Spa should be given £15 each from Club funds towards their expenses. In response to an appeal, a £25 donation was sent to a disabled bowler, Richard Coates, to help towards the funds required for his participation in the Para-Olympic Games in Korea. The 1987 Annual dinner was held again in Ponteland Golf Club.

The Ladies' Section celebrated their 21st Anniversary in 1988. At the 1988 Spring meeting, attended by 29 members, it was mentioned that there were 15 names on the Waiting List. It was agreed that arrangements should be made for the Ladies' Section to have Honours' Boards costing £144 to be displayed in the Pavilion. In

connection with the Rules of the Ladies' Section, a change was made to Rule 6 regarding the tenure of service as an office bearer. The Treasurer reported that the coffee mornings raised £254 with a balance of £1,601 in the Accounts. Members agreed to their annual subscription being raised from £12 to £18, having been unchanged since 1984. It was decided that office bearers should write a job description of their duties for guidance to new members. A coach trip was arranged to take members to watch the International Series at Spennymoor, Durham. In October 1988, the Annual dinner and a Domino & Whist Drive, which raised over £120 in aid of Ponteland Hospital were both held in PMH. In connection with domestic competitions, it was decided that the runners-up would be given money to purchase a trophy of their own choice.

At the 1989 Spring meeting, attended by 29 members, the Treasurer reported a balance of £1,834 in the Accounts. The regular coffee mornings raised £178 and a further sum of £102 for charitable donations. The annual subscription was increased by £2 to £20. A team was entered for the National Mixed Fours competition which raised £158 from both sponsorship of their game and a special raffle. The proceeds were donated to Cancer Research UK. In the National Mixed Pairs competition, it was reported that both M.A. Bennett and N. Rutherford played very well throughout several rounds. A friendly fixture was arranged with the newly formed Gosforth Garden Village Ladies B.C. However, as in the case of the Men's Section, there was difficulty in getting members to play in some friendly fixtures. It was decided that, in future, league team players would pay their own travel expenses to assist with the financial situation. The 1989 Ladies v. Gents match was won by the ladies, the last occasion being in 1981. The Secretary expressed her appreciation of the help given by some members of the Men's Section on official occasions and especially during the Ladies' Triples domestic competition. The 1989 Annual dinner was held in The Diamond Inn.



**Mrs Elizabeth French after the investiture by Prince Charles of the M.B.E. in recognition of Services to Education, March 1986**



**PBC Ladies, 1987**

**(l - r) : L. Barrons, N.F. Orton (President), J. Graham, M. Little,  
M. Myers, T. Wright, W.O. Carse, I. Fletcher, B. Johnston,  
N. Rutherford, M. Barclay and M. Shuttleworth**



**Ladies' Section 21st Anniversary, 1988**

**Back Row (l - r) : J. Graham, J. Cosby, N.F. Orton, I. Fletcher, E. Newton,  
T. Wright, W.O. Carse and B. Stafford**  
**Front Row (l - r) : B. Johnston, E. Brown, F. Owen, N. Rutherford, L. Stockman,  
G. Cattliff, D. Emery, E. Younger, M. Cassie, M. Duff, M. Myers,  
M. Little, K. Armstrong, M. Shuttleworth and D. Lumley**

At the 1990 Spring meeting, attended by 28 members, the Treasurer reported that coffee mornings during the winter raised £202, with a balance of £1,900 in the Accounts. Income from visitor's fees amounted to £82. New bowling mats and jacks were purchased in time for the new season.

In June 1990, an EGM, attended by 34 members, was held to discuss a proposition put forward by the Men's Section in connection with the 30 persons on the long Ladies' Waiting List which showed no movement in the previous four years. The Secretary read out a letter from the Men's Secretary with their suggestion that ten ladies on the Waiting List should be offered visiting membership in 1990, enabling them to play on Tuesday and Thursday afternoons at a cost of £1 per visit. They would have no right of membership but it would ease the problem of the large number of ladies wishing to play bowls. It would be necessary to report back to the Men's Section for further discussion at their AGM to be held in October. Everyone was delighted with the proposal and looked forward to welcoming newcomers to the Club.

At the 1990 AGM the annual subscription rose to £25. Members were informed that the County Secretary had a list of drugs not to be used when participating in competitions. The Secretary, M. Shuttleworth, in her report on the season's activities included a most interesting and perceptive statement. *'The idea of our being equal members with the men is not going to happen overnight, but I can report on the increased co-operation and discussion which has taken place over the last couple of years. We are far more integrated than many other private clubs, and indeed are happier than most, but I think it needs some chiselling the old block to get things changed rather than a full frontal attack.'*

It is satisfying to record that her aims and that of other members were realised with the amalgamation of the membership in 2000. It was reported that some of the ladies upon resigning from the Club wished to keep in touch with members, and it was decided to form an association, viz. "Friends of PBC Ladies" who would receive the fixture lists and news of social events. A total of £75 was raised from sponsorship of the National Mixed Fours competition in aid of Cancer Research UK. In October 1990, a donation of £80 was made to Crossroads Day Centre, a charity caring for Carers. The 1990 Annual dinner was held in Ponteland Golf Club.

At the 1991 Spring meeting, attended by 26 members, the Treasurer reported a sum of £1,721 in the Deposit Account, with coffee mornings having raised £234. Members were informed that the Ladies' Management Committee agreed with the Men's GPC that outside labour should be employed to clean the Pavilion; each Section to pay 50% of the cost. In the past, members of the Ladies' Section had carried out this work on a voluntary basis.

At the 1991 AGM it was decided to increase the annual subscription by 20% to £30 and to remove the honorarium originally awarded to the Match Secretary in 1984. The other honoraria awarded to both the Secretary and the Treasurer in 1981 were to remain, also that of the President which was awarded in 1984. Several members participated in three semi-finals of the County competitions. The Secretary, possibly with tongue in cheek, said *'We can't keep winning all the time, and perhaps it saves on engraving fees and space on the Honours Board.'* The Ladies v. Gents end-of-season match was won by the ladies. The 1991 Annual dinner was held in Newcastle Aero Club.

At the 1992 Spring meeting, attended by 31 members, it was mentioned that there were 53 names on the Waiting List. The Treasurer commented on the magnificent support given by members at the coffee mornings held during the winter on raising £341. After deciding to make a payment of £1,700 towards the considerable Club

expenditure on Pavilion repairs, green maintenance, and a new equipment store, it was reported there was a balance of £1,640 in the Accounts. It was agreed that a Ladies' Gala Day, celebrating 25th anniversary of the Ladies' Section, would be combined with Lady President's Day and be an all-day occasion. Regarding the borders surrounding the green, K. Armstrong, J. Graham and M. Healy were thanked for providing roses for the new flower beds. The first friendly fixture was arranged with Gosforth Ladies B.C.

At the 1992 AGM the Secretary read out a letter from the County Lady President, B. Johnston, thanking members for the flowers she had received and the monetary gift used to purchase a set of opal ear-rings. Prior to the meeting, the Secretary obtained details of the members' age groups for the Sports Council census.

In 1992 a substantial majority of the members agreed with the proposed ban on smoking in the Pavilion.



Miss Ora Carse with Lord-Lieutenant Lord Ridley  
Awarded B.E.M. in recognition of service in the W.R.V.S., 1988

At the 1993 Spring meeting, attended by 38 members, the Treasurer reported a balance of £1,751 in the Accounts after payment of £1,574 towards a total Club expenditure of £4,204. The winter coffee mornings raised £353, the proceeds of which, in future, would be used to subsidize transport costs for matches. The Secretary stated that she had received an assurance from the Council that the appropriate Committee would consider the suggestion that a bowling green be made available at the Sports Centre. Members were informed of the M.B.E. for service with the Red Cross recently awarded to Mary Coard.

At the 1993 AGM, attended by 34 members, the Treasurer stated that the annual subscription would have to be increased as only a small profit had been made on the activities throughout the year. It was agreed that it be raised to £35. As the price of

silver spoons, awarded to winners of the Jumbles competitions, had risen significantly it was agreed that the entrance fee be increased to 30p. Members were informed that a payment well in excess of £2,000 was due to the Men's Section for their use of the facilities at the bowling green.

At the 1994 Spring meeting the Treasurer reported that regular coffee mornings raised £340, with a balance of £1,084 in the Accounts. The President, F. Owen, was thanked for her very generous gift of a new refrigerator for the Pavilion kitchen. The Match Secretary informed the members that an Honorary Life Member, E.M. Roper, now living in North Yorkshire, had requested her local Club, Stokesley B.C., to arrange a match with Ponteland. The members were pleased to accept the invitation to meet up with a most popular and active member of the Club. During the meeting it was proposed and agreed that five founder members of the Ladies' Section should receive Honorary Life Membership with full membership rights. Details are shown in Section 2.2.1.

At the 1995 Spring meeting, attended by 34 members, it was mentioned that there were 62 names on the Waiting List. The Treasurer reported that coffee mornings raised £339, with a balance of £1,689 in the Accounts. Prior to the meeting, J.T. Harrison gave a presentation on the preliminary work undertaken by his sub-Committee investigating the possibility of extending the Pavilion. The President, A. Gill, asked members to write in with any comments which would be passed on to the sub-Committee.

At the 1995 AGM, attended by 39 members, the Treasurer reported that the winter coffee mornings raised £339. Additional income of £319 was obtained from competitions and raffles. A payment of £1,850 was made to the Men's Section for use of the facilities at the green. The Secretary remarked that she had received many complimentary remarks from visitors on the condition of the bowling green and was grateful to both the Green Ranger, R. Stafford, and the Green's Committee for their hard work.



**Ladies' President's Day, 1990**

(l - r) : Mesdames N. Rutherford, J. Graham and W.O. Carse, R. Stafford, Mesdames D. Lumley and M. Healy, C. Walters, Mesdames B. Stafford and K. Armstrong, D. Boland and G.C. Nicholson, Mrs J. Cosby, K. Griffiths, Mesdames T. Wright, I. Fletcher, G. Cattliff and M. Myers, E. Scholes, Mesdames M. Scarlett and F. Jeffs, S.A. Swift and G. Warner, Mesdames L. Barrons, E. French and J. Trimble, A.M. Maclean, Mesdames L. Stockman and M. Cassie, ? , J.W. Nesbit, Mesdames M.E.H. Nesbit and F. Owen, A.H. Baker, R. Elder, S. Wright and ? , Mrs E. Walters, ? , Mrs M. Shuttleworth, ? , ? , R.I. Shuttleworth, T. Lumley and W.R. Liddle, Mrs I. Cassidy and G. Bowmer



**Founder Members of the Ladies' Section Attending PBC  
25<sup>th</sup> Anniversary Celebration, June 1992  
(l - r) : Marjory Cassie, Ena Younger, Dorothy Crofts, Lil Stockman  
and Gwen Cattliff**



**Ladies' President's Day, 1992**

**Ladies (l - r) : M. Duff, T. Wright, E. French, A. Gill, M. Little, K. Armstrong,  
M. Myers, J. Cosby, L. Barrons, D. Lumley, M. Cassie, J. Graham,  
E. Newton, G. Cattliff, B. Johnston, L. Stockman, M. Lowthian,  
M. Shuttleworth, M. Scarlett, D. Crofts, M. Williamson, B. Stafford,  
E. Younger, I. Cassidy, F. Jeffs, L. Telfer, W.O. Carse, M. Tailford,  
G. Jordan, M. Healy, M. Bryson, N.F. Orton, F. Owen and I. Fletcher**

**Men (l - r) : J. Roberts, E.S. Johnson, K. Griffiths, R. Elder, G. Warner, S. Vine,  
A. Turner, P. Telfer, J.T. Harrison, T. Nichol, N. French, J.W. Atkinson,  
L. Crofts, J. Wood, R.I. Shuttleworth (President), J. English, G. Skinner,  
G.D. Bennett, J. Lunn, S.A. Swift, E. Scholes, T. Lumley, M. Edison,  
W. Robinson, A. Harper, G. Attwater, D. Hindmarsh, J.S. Duff and  
R. Stafford**

**Front Row : J.W. and Mrs M.E.H. Nesbit (President)**

At the 1996 Spring meeting, attended by 31 members, it was mentioned that there were 63 names on the Waiting List. The Treasurer stated that coffee mornings raised well over £300, with a balance of £2,396 in the Accounts. A sum of £45 was raised in a raffle to help send a member of a Visually Handicapped Team to the World Bowls Tournament.

At the 1996 AGM, attended by 40 members, the Treasurer reported that the winter coffee mornings raised £404. Additional income of £258 was raised from the competitions and raffles. There was a balance of £4,965 which was a £700 increase on the balance in 1995. A payment of £1,769 was made to the Men's Section for use of the facilities at the green. The planned installation of a new automatic watering system at the green had been delayed as an application had been made to the National Lottery Commission for financial assistance. The application, however, was unsuccessful. The 1996 Annual dinner was held in Ponteland Golf Club.

At the 1997 Spring meeting, attended by 39 members, it was mentioned that there were 68 names on the Waiting List. The Treasurer stated that winter coffee mornings raised £252, with a balance of £3,786 in the Accounts. An afternoon knock-out competition, the Rainbow Trophy, was introduced for those members not having played in a 2-, 3- or 4-Bowl final during the previous five years. Following the match at Stokesley B.C. in 1994 a mixed friendly match had been arranged to take place at Ponteland with E.M. Roper's Club at Great Ayton. Concerning NCWBA matters, the Secretary read out from their report its regret that M. Shuttleworth had resigned from the position of Assistant Secretary.

At the 1997 AGM, attended by 36 members, the President, M. Healy, expressed deep regret at the passing of Marjorie Duff who with her husband, John, had for several years greatly assisted with the Club's finances by holding annual garden parties at their home. The Treasurer stated that their finances were in good order with a £500 increase on the balance in 1996. The Statement of Accounts showed £568 had been raised from the winter coffee mornings, raffles and competitions. However, the Ladies' Section were required to pay approximately £4,000 as their share of the cost of installing a new automatic watering system around the bowling green. Also, a payment of £1,734 was made to the Men's Section for use of the facilities at the green.

At the 1998 AGM, attended by 36 members, the Treasurer stated their financial commitments would amount to £3,500 taking account of their part in repairing the Pavilion, green maintenance, and laying flagstones at the bank-sides. Also, in response to an appeal by PMH for financial assistance, the "Table Top" Sale held in PMH was a resounding success and raised £2,130. The two stalls set up by the Club raised about two-thirds of the total sum including donations. The daughters of the late Mary Little also attended the meeting and presented a silver salver in Mary's memory with the inscription "To Always Play The Game". The salver would be presented annually to members who have made noteworthy efforts on behalf of the Club.

At the 1999 Spring meeting, attended by 38 members, the Treasurer reported a balance of £2,355 in the Accounts with £3,900 having been paid towards the costs involved for alterations to the Pavilion and for green maintenance. required to pay approximately £4,000 as their share of the cost of installing a new automatic watering system around the bowling green. Also, a payment of £1,734 was made to the Men's Section for use of the facilities at the green.

At the 1998 Spring meeting, attended by 36 members, the Treasurer reported a balance of £4,200 in the Accounts excluding annual subscriptions. £316 was raised from the winter coffee mornings. The annual subscription was increased to £50 as a sum of £3,771 had been paid towards green maintenance and improvements. It was decided that the Selection Committee would appoint a Captain for each fixture, who would be responsible for making arrangements on the day of the match.



At the 1999 Annual General Meeting, attended by 33 members, the President considered it was an honour for the Club to host the match between the EWBA President's touring team and the NCWBA. The Treasurer reported that a profit of £720 was made from the winter coffee mornings, raffles and sales of tea & coffee at each of Noreen Rutherford's NCWBA President's functions. The Secretary stated that every member of the Club would receive a copy of the new draft Constitution which would be voted on at a Combined AGM.

At the 2000 AGM, attended by 30 members, it was stated that after 17 years' service, I. Fletcher had resigned from the position of County Treasurer. Members were thanked by the NCWBA for hosting the match against Lancashire. The Secretary stated that £153 had been passed on to the Treasurer, E.W. Lowthian. Members were informed of four coaching sessions to be held each week at the beginning of the 2001 season. Following the amalgamation of the Club's membership it was agreed that the first year had been successful, and the President was pleased that M.E.H. Nesbit would be standing as the Club Lady Chairman.

At the 2001 Spring General Meeting, attended by 47 members, it was mentioned coaching lessons would be available on four days' each week at the beginning of the season. M.E.H. Nesbit provided details of the proposed plans for the new Clubhouse.

At the 2001 AGM, attended by 41 members, it was stated that there had been few problems following the amalgamation of the Club membership and the arrival of new members from the Waiting List. The County representative stated that the names and addresses of all Club members had been submitted to the County Secretary for the purposes of forming a National Register. Later on, membership cards were issued.

At the 2002 Spring meeting, attended by 46 members, the President thanked members for their efforts in raising over £360 from the winter coffee mornings. Also, H. Furniss was thanked for organising an informal indoor league. It was announced that our County players are invited to attend a "Picnic & Play" event at Royal Leamington Spa to celebrate the Queen's Golden Jubilee.

At the 2001 Spring meeting, attended by 47 members, it was mentioned that At the 2002 AGM, attended by 45 members, it was reported that the winter coffee mornings, book sales, raffles and competitions raised £249. Members agreed with the proposal that the Club be admitted to the North-Eastern Ladies league which required matches to be played on Tuesday afternoons. The President, N. Caldwell, considered one of the highlights of the season had been the Queen's Golden Jubilee Gala Day Jumbles, held in June.

At the 2003 Spring meeting, attended by 54 members, it was mentioned that the Club had received notification from the County that no young person can be allowed on the bowling green without written parental permission. Also, that qualified coaches would have to complete the necessary forms.

At the 2003 AGM, attended by 57 members, it was reported that the winter coffee mornings, book sales, raffles and competitions had raised £286. The President, L. Telfer, thanked all the Committee members for their support and expressed her pleasure at having use of the new Clubhouse throughout the season.

In January 2004, members attended the 90th birthday celebration of Dorothy Crofts, a founder member of the Ladies' Section in 1967.

At the 2004 Spring meeting, attended by 49 members, the Secretary stated that the monthly winter coffee mornings, with two remaining, raised over £550. In connection with the domestic competitions, members were informed that J. Nichol was the only Official Registered Marker in the Ladies' Section.

At the 2004 AGM, attended by 39 members, the Treasurer reported over £700 had been raised from coffee mornings and another £288 from book sales, raffles and competitions. In connection with the domestic competitions, members were again reminded that J. Nichol was the only Official Registered Marker, along with two others in the Men's Section. In the absence of an umpire, marking in competitions by members has been carried out, in many cases, with little knowledge of the official duties of a Marker as laid down in the EBA Rules. As a matter of interest, in 1975 and 1976 the Men's Secretary included "Duties of Marker" in the Club's Rules and Fixtures booklets which were issued to all members. Thereafter, for financial reasons, the small booklet which also contained the names of Club Officers, competition rules, members' names with addresses and telephone numbers, was discontinued.

At the 2005 Spring meeting, attended by 52 members, the Secretary informed members that the dress code for Collins & Shipley and NEL league matches are the same and should be strictly adhered to. Members were asked to support the Club's representatives at the forthcoming NEL Spring meeting. Members were reminded that coaching sessions are available with H. Robson, W.R. Liddle and R.I. Shuttleworth. The County representative, L. Telfer, stated that the EWBA were experiencing financial difficulties. Also, concerning C. & S. fixtures, plain white baseball caps could be worn but umbrellas were not allowed on the green.

At the 2005 AGM, attended by 48 members, the Treasurer stated membership had fallen from the permitted maximum of 100 in 2003 down to 89. This situation could impact on subscription levels unless there was an influx of new members. It was reported that the winter coffee mornings raised over £500. A further £472 was raised from book sales, raffles and competitions. After expenses, the remaining income was passed on to the Treasurer. In connection with the County competitions, it was decided that a total of £120 from Club funds be awarded to members who participated in the National Finals at Royal Leamington Spa. A decision was taken not to make any arrangements for a County match as the Clubhouse could not accommodate 65 or more persons for the meal after the match. PMH was an alternative venue, but its hire charges were found to be too expensive. Perhaps, on reflection, it was rather unfortunate that the Clubhouse length was reduced by three metres, as a cost-saving measure, when built in 2003. In September 2005, thirteen members attended a seminar "On the Duties of a Marker" at Hexham B.C. At present, two members are qualified Markers for NCWBA competitions. M.E.H. Nesbit accepted the position of County representative. At the end of the meeting the President, M. Cowan, mentioned the passing of Gwen Cattliff a very active and founder member of the Ladies' Section.

At the 2006 Spring meeting, attended by 53 members, the Secretary reported that the winter coffee mornings raised over £550. In connection with the Nan MacLeod trophy, the members were informed that in order to qualify for the award at the end of the season a minimum of eight appearances was required. Weekly winners have the option of a silver spoon or money. It was announced that the Men's Section has three qualified coaches viz. W.R. Liddle, H. Robson and R.I. Shuttleworth who are willing to hold coaching sessions for lady members.

At the 2006 Annual General Meeting, attended by 49 members, it was stated that in addition to the income from coffee mornings, £450 was raised from book sales, raffles and competitions. After expenses, the remaining income was passed on to the Treasurer. Following discussion on a series of ideas, it was decided to award the Mary Little Memorial Salver in 2007 as a trial round-robin competition for the Over 75s. It would be held on a Friday afternoon and played with two bowls over eight ends. The runner-up 'To receive a packet of Wine Gums.' The 2006 Annual dinner was held in Ponteland Golf Club.

At the 2007 Spring meeting the Secretary reported that the winter coffee mornings raised £556. The County representative, M.E.H. Nesbit, informed members

when unification of the National Body takes place it will be renamed Bowls England. Consequently, both the NCBA and NCWBA will be renamed Bowls Northumberland.

At the 2007 AGM, attended by 39 members, it was reported that in addition to the income from regular coffee mornings, £516 was raised from book sales, raffles and competitions. After expenses, the remaining income was passed on to the Treasurer. The position of Match Secretary was first undertaken in 1983 by B. Johnston. Now, with the increasing fixtures list J. Howell kindly agreed to take on the position. The newly elected President, M. Richardson, congratulated M.E.H. Nesbit on completing an 8-week coaching course. The 2007 Annual dinner was held in Kirkley Hall.

At the 2008 Spring meeting, attended by 49 members, the Secretary reported £446 had been raised from the winter coffee mornings. The Match Secretary, J. Howell, was thanked for arranging the friendly matches in good time enabling early printing of the Fixtures booklet. Members were informed that D.A. McDonnell had received her Junior Vice President's badge and would be County Lady President in 2010.

At the 2008 AGM attended by 50 members, the President announced that Vice President, J. Marshall, was seriously ill and unable to continue participating in Club affairs. M. Brown agreed to take over as Vice President and N. Caldwell the position of Secretary. It was reported that in addition to the income from winter coffee mornings a further £275 was raised from book sales, raffles and competitions. After expenses, the remaining income was passed on to the Treasurer. It was reported that the "Top Ten" competition would be replaced with a Double Rinks event in 2009. The 2008 Annual dinner was held in Ponteland Golf Club.

At the 2009 Spring meeting, attended by 50 members, it was reported that the winter coffee mornings raised £527. Members were informed that D.A. McDonnell, the County Vice President, would appreciate their support on the occasions of the County Pairs Semi-Finals and the match between Northumberland and Yorkshire. The GPC agreed that the Rinks' team be given £120 from Club funds to help towards their expenses at Royal Leamington Spa.

At the 2009 AGM, attended by 52 members, it was reported that in addition to the income from winter coffee mornings £574 was raised from book sales, raffles and competitions. After expenses, £400 was passed on to the Treasurer. On behalf of the members the President, M. Cowan, wished D.A. McDonnell the very best in her forthcoming role as County Lady President. The 2009 Annual dinner was held in Ponteland Golf Club.

At the 2010 Spring meeting, attended by 49 members, the newly appointed Secretary, E. Gatenby, reported that the winter coffee mornings raised £564. Members were informed that the Green's Committee had an extensive work programme in hand before Opening Day and the Green Ranger would appreciate any help that the ladies could provide around the green. Reference was made to supporting D.A. McDonnell in her year as County Lady President. In connection with the league fixtures, the President requested that members wear the approved yellow cardigans.

At the 2010 AGM, attended by 48 members, it was reported that in addition to the income from winter coffee mornings £470 was raised from book sales, raffles and competitions. After expenses, £868 was passed on to the Treasurer. A. Rutter, the President, then read out a letter from D.A. McDonnell thanking members for their support in her year as County Lady President. In connection with the domestic competitions, it was stated that the Nan MacLeod Memorial salvers, presented to the Club in 1982, were not in a serviceable condition and the President had donated two trophies in their stead. At the close of the meeting A. Rutter thanked E. Gatenby for her excellent work as Secretary. The 2010 Annual dinner was held in Ponteland Golf Club.

At the 2011 Spring meeting, attended by 47 members, the Secretary reported that the winter coffee mornings raised £575. Members were informed that the finalists in the four main domestic competitions in 2011 would receive small trophies in lieu of monetary gifts of £5 and £3. A gift of sixty-five 10" dinner plates matching the Club's crockery was presented to the Club by A. Rutter and A. Brennan to mark their presidencies respectively in 2010 and 2011.

At the 2011 AGM, attended by 56 members, it was reported that in addition to the income from winter coffee mornings, £491 was raised from book sales, raffles and competitions. After expenses, £782 was passed on to the Treasurer. A. Brennan, the President, informed members that their views would be sought at the 2011 Combined AGM when a proposal by the Treasurer, endorsed by the GPC, concerning the entrance fee for new members would be discussed. Several opinions were expressed on alternative solutions to the entrance fee. Following her report as the Club's County representative, a position held since 2005, M.E.H. Nesbit expressed great pleasure in handing over the reins to M. Cowan. It was reported that coaching lessons held once a week for six weeks had been poorly attended. Concerning routine maintenance work around the green, the Secretary stated that, when requested on their notice board, the Green's Committee would appreciate additional help from lady members. The 2011 Annual dinner was held in Ponteland Golf Club.

At the 2012 Spring meeting, attended by 43 members, it was announced the GPC has decided that the Gala Day Jumbles arranged for the 4<sup>th</sup> June will commemorate the Queen's Diamond Jubilee with members dressed in red, white and blue. The newly appointed Secretary, S.A. Storey, thanked members who had helped organise the very successful social activities during the winter months and mentioned the £670 raised from the winter coffee mornings. Also, members were informed that E. Shuttleworth would again be opening her garden to members during the summer.

At the 2012 AGM, attended by 47 members, the President, E. Gatenby, on welcoming the members referred to unfortunate health problems of several ladies. J. Nichol for many years a member of the County team had now retired for health reasons. The President mentioned that three members had entered their 80s, two were now in their 90s and that Joan and Ron Smith (from the Men's Section) had celebrated their Diamond Wedding Anniversary. In connection with social events, it was reported that the coffee mornings had raised £609 which was passed on to the Treasurer. Reference was made to the perennial problem with finding members willing to serve on the very important Social Committee. The efforts of the Green's Committee and others were well rewarded when it was announced that the Club had been awarded a Gold Medal Certificate in the "Northumbria In Bloom" competition. Although the weather had been the wettest on record only a few matches needed to be re-arranged. Members were informed that E. Gatenby had recently qualified to officiate as an umpire. The members agreed with a proposal by M.E.H. Nesbit that G. Stapylton be elected Vice President of the County in 2013. The Annual dinner was held again in Ponteland Golf Club.

Sadly, Dorothy Crofts a former Secretary, Treasurer, President, Honorary Life and founder member of the Ladies' Section, who was residing with her family in Hampshire, passed away in February 2013 shortly before her 100th birthday.

At the 2013 Spring meeting, attended by 37 members, The President, Joyce Pringle, welcomed members having braved adverse weather conditions. Members were invited to donate home-made products, arts and crafts etc for the charity tea to be held in the Clubhouse on the 12<sup>th</sup> July. The funds raised will help toward the splendid work carried out at the RVI Great North Children's Hospital.

The President thanked both M. Cowan for her work as Club Secretary during the past seven years and N. Caldwell for her efforts as Chair of the Club during the past

year. Both ladies were presented with plants on behalf of the Ladies' Section. Following the recent death of a member the President announced that after a great deal of deliberation the GPC had taken the decision that no longer would relatives be allowed to spread the ashes of deceased members around the grounds of the Club.

Members were informed that the County were seeking volunteers for the position of Vice President. Following the meeting Gloria Stapylton expressed an interest and was duly appointed.

At the 2013 AGM, attended by 45 members, the President announced that the Club website could be used by members for posting obituaries. It was reported that both teams performed well in the Collins & Shipley matches. The results obtained in the County competitions are shown in Section 2.2. It was stated that the 90<sup>th</sup> Anniversary of the Club this year was celebrated with a fancy dress Presidents' Day, a barbecue and photographic display of the history of the Club. Another highlight of the year was the charity tea in the Clubhouse which raised well over £500 for the President's chosen charity viz. the RVI Great North Children's Hospital.

The Secretary, S.A. Storey, explained the role of the GPC for the benefit of new members and also the Club's efforts in achieving Bowls England Club Mark Accreditation. The requirements were that the Club can demonstrate its efficiency in financial accountability, that health & safety regulations are in place and adhered to, policies for the welfare of members are in place and that the coaching staff are appropriately trained. A Club Handbook has been produced for this purpose.

Members were informed that the Secretary had been appointed the Club's Welfare Officer and P.A. Dodds the nominated First Aider. The kitchen was inspected by the Council and the Club awarded the top grade viz 5-star.

E. Gatenby was thanked by the Secretary for organising the friendly fixtures and congratulated again on qualifying as a regional umpire. Thanks were extended to J. Nixon, M. Catchpole, M. Richardson and J. Howell for their efforts on behalf of the Club. The County representative, M. Cowan, reported that the Club had nominated Vice President, G. Stapylton, as County President and M. Turner as County Secretary for 2014. The nominations of both G. Stapylton and M. Turner were confirmed later at the County meeting of delegates. Members were encouraged to participate in the new Bowls Northumberland County Mixed Pairs competition. The unified Finals Day had been a huge success and in 2014 would be spread over two days.

Following the election of Officers and Committee members, the proposal for a new class of member viz a Social Member was discussed. It would accommodate both husbands and wives of current members who would like to be associated with the Club. It was announced that arrangements had been made for pupils from Richard Coates Middle School to attend some coaching sessions on Friday afternoons.

At the 2014 Spring meeting, attended by 38 members, R. Johnson, the President, announced that there is to be a joint Presidents' fund-raising event this year in aid of the Great North Air Ambulance. Past President, Joyce Pringle, was thanked for her kind donation of glass table- numbered plaques which will be used for league matches. A very successful pre-season dinner was held in The Highlander which raised £182.

The Secretary, S. A. Storey, reported on the wide and varied social programme throughout the closed season enabling members to keep in touch. The coffee mornings had raised £820 towards transport costs for the ladies' matches and M. Catchpole was thanked for managing the Social Account.

At the close of the 2014 season the Club achieved Club Mark status, the first outdoor bowling club in Northumberland to do so. Best wishes were extended to both

G. Stapylton and M. Turner following their successful nominations as County Lady President and Treasurer respectively. Two County matches were arranged to take place at Ponteland against Cumbria and Yorkshire. A second PBC team would participate in the Public Utilities League and nine friendly matches were arranged.

It was announced that in addition to the coaching sessions organised for the public in May, arrangements had been made for pupils from Richard Coates Middle School to attend some coaching sessions on Friday afternoons.

County representative, M. Cowan, announced that BN Ladies' Section have offered a 4-Bowl runners-up trophy for the annual National Championships held at Royal Leamington Spa. M. Cowan assured both G. Stapylton and M. Turner that the Club will be willing to help in any way that it can during their terms in office. At the close of the meeting members were asked if anyone would consider taking over the position of Secretary as this was the last year of tenure for S.A. Storey.

At the 2014 AGM, attended by 38 members, the President, R. Johnson, informed members of the passing of Noreen Rutherford who was County President in 1999. With regard to competitions, the President congratulated members of the two Collins & Shipley teams on their performance during the season. She also congratulated both J. Nixon and D.W. Morrison on winning the inaugural County Mixed Pairs competition. Mention was made that the Ladies' Section had won the Armstrong Trophy this year. Thanks were extended to all the members of the various Committees for their efforts on behalf of the Club. Several members are celebrating their 80<sup>th</sup> birthday this year and have invited members to attend a joint celebration.

The Secretary reported that the winter social programme was well supported. The events included Dominoes with a Difference, a Domino Drive, a Beetle Drive, a Night Out at Fratelli's and a Quiz Night. Thankfully, the efforts of Club Coaches and helpers with the Taster Sessions held in May attracted 13 new members. It was asserted that although the Club has healthy numbers further members were necessary to avoid the situation of closure as had occurred with other bowling clubs.

P. Haylock congratulated members on the results of County competitions, details of which are presented in Section 2.2. She stated that next year there will be a Finals Day for the 2-, 3- and 4-Bowl competitions to be held on the first weekend in August.

L. Telfer stated that one of the difficulties facing the Selection Committee was that so many members wanted to play, but only a limited number could be selected. She suggested that members continue to put their names down for friendly matches and let their bowls do the talking !!! If only the Men's Section Selection Committee had the same problem !!!

County representative, M. Cowan, reported on the last delegates meeting. A new Mixed League should commence in 2017. The 4-Bowls runners-up trophy donated by Bowls Northumberland was presented for the first time by BN Ladies' President, G. Stapylton, and Secretary, M. Turner alongside the Bowls England Officers at Royal Leamington Spa.

Following the election of Club Officers and Committee members, M. Cowan thanked S.A. Storey for her efforts over the past three years as Secretary. She will stay on for another year, however, in order to 'train up' somebody else to take over next year.

At the 2015 Spring meeting, attended by 38 members, the President, E. Cowings, thanked members for supporting the winter programme and the coffee mornings. Thanks were extended to the Green Ranger, W.R. Liddle, and his team of volunteers who helped throughout the winter preparing the green which can be seen to

be in excellent condition for the forthcoming season.

The Secretary, S.A. Storey, announced that only one team would be entered in the Public Utilities League this year due to management difficulties in supporting two teams when other Club fixtures take place in the afternoon. J. Nixon, P. Haylock and E.J. Ramsey were thanked for all the work they had undertaken last year. The Ladies' Committee have agreed that in the case of a tie in the Nan MacLeod competition the joint winners to receive a spoon or £4. This year the Taster Sessions would take place on a combination of Fridays and Saturdays. This is an important event as the Club needs newcomers to replace those who have retired from bowling.

County representative, M. Cowan, drew attention to the County competitions and league fixtures. Members were also informed that Tynemouth have disbanded but the application by Hexham House has been accepted. The Club has four new players representing the County viz. A. Brennan, P. Haylock, R. Johnson and S.A. Storey in addition to current members M. Cowan, E. Emmerson, G. Stapylton and M. Turner. The Club hosted two BN matches against Cumbria and Yorkshire.

At the 2015 AGM, attended by 43 members, the President, E. Cowings, congratulated the ladies who had represented the Club finishing runners-up in the Public Utilities League. Thanks were extended also to the Vice President, S.A. Storey, Committee members, and many others for their help when required. The Secretary reported that the schools programme had been successful and, whilst this was seen as the way forward for the future of the Club, it will be reviewed for next year. There is the possibility of two new competitions next year viz. a County Mixed Double Rinks and a Friday Friendly League. M. Catchpole was thanked for managing the Social Account for several years but a volunteer was needed to take over her role. Also, J. Howell and M. Richardson were both thanked for their housekeeping activities.

Results of the County and domestic competitions are presented in Sections 2.2 and 11.2 respectively. Unfortunately, delays in completing earlier rounds of some competitions seriously affected completion of games towards the end of the season. It was agreed that in future, the competitions be more closely monitored and set dates adhered to. County representative, M. Cowan, reported fully on the last delegates meeting. All competition fees have been increased by 50p and participants may play in official Bowls England shorts !!!! She congratulated players on their performance at Royal Leamington Spa.

N. Caldwell proposed and was seconded by M. Richardson, that an Assistant Secretary be elected annually, for a maximum period of three years, to work closely alongside the Secretary and share an agreed workload. She would not, however, be obliged to become a secretary. The proposal was agreed by a show of hands. It may be seen from the AGM held in 1983, the position of Match Secretary was created who, in keeping with other Officers at that time, did not pay an annual subscription.

Following the election of Officers and Committee members, S.A. Storey, the newly elected President, thanked retiring Committee members for their efforts and wished the incoming Committee members a happy and successful tenure of office.

At the 2016 Spring meeting, attended by 40 members, the newly appointed Secretary, E.J. Ramsay, said it was good to see more men attending the very successful winter monthly coffee mornings. A most successful Burns' Night was held in Ponteland Golf Club which raised £632 from the raffle and ticket sales. The Quiz Night was well supported with 40 tickets sold and £124 raised for the Club. Thanks were extended to C. Davison and her helpers for the Supper and with a glass of wine. The Domino Drive was well supported and P. Kilmister was thanked for organising the event, also A. Rutter with her team for providing the afternoon tea. The remaining event was the pre-season dinner held in Ponteland Golf Club.

The Selection Committee has met and decided to change the teams for league matches. The first team will play in Collins & Shipley Div.1, the second will play in the NEL and the third in Collins & Shipley Div.2. This arrangement enables any member of the NEL team to participate in Collins & Shipley matches. Players in all league matches must adhere to the correct dress code. Only nine members showed any interest in playing in the Public Utilities League. Ten members indicated their interest in playing in the new Friday Friendly League.

Members were informed of the repair work carried out on the end rinks of the green alongside PMH and the tennis courts during the closed season. In connection with Opening Day, it was agreed that a cup should be awarded annually to the winner of the day. It would be named the Queen Elizabeth Cup 2016 to commemorate the Queen's 90<sup>th</sup> birthday. The Town Mayor, Cllr Carl Rawlings, will present it this year. Members were encouraged to wear a little red and or blue on their whites dress. Tea to be held in PMH. Members were encouraged to read the regular PBC Newsletter either online or on the notice board in the Clubhouse.

At the 2016 AGM, attended by 43 members, the President, S.A. Storey, announced that members of the Ladies' Section will be invited to think of ways to celebrate its 50<sup>th</sup> anniversary during 2017. It has been suggested that a booklet be produced containing members' memories of events over the years.

The Secretary, E.J. Ramsay, referred to the events during the winter programme. The Club had again been awarded the BDA grant of £290 for services to the community involving five Taster Sessions at the beginning of the season. These were advertised in Pont News and Views and were well attended resulting in the recruitment of 10 new lady members. Sadly, due to the overall lack of interest on the part of children from Richard Coates School, who were invited to try bowling last year, the GPC has decided not to include this in the 2017 programme.

Concerning domestic competitions G. Stapylton reported that they had run smoothly with everyone complying with the "play by" dates. Details of the winners are presented in Section 11.2. Both E. Emmerson and S. O'Rourke both participated in the County "Champion of Champions" competitions with S. O'Rourke reaching the semi-final in the 4-Bowl event.

In 2016, Ponteland Ladies had eight representatives playing in the Northern Counties and Stella Logan fixtures. This was the highest number since 2000 and 1997 when 8 and 10 players respectively represented the County. The Club hosted the Stella Logan match between Northumberland and Lancashire. Details of County competition results are presented in Section 5.2. In closing, G. Stapylton thanked the members of the Selection Committee for their work concerning team selection for both the league and friendly fixtures.

County representative, M. Cowan, referred to the proposal by Benfield to reduce the number of players in the Collins & Shipley fixtures from 12 to 9. Following a vote taken at the meeting the members agreed the Club should vote against the resolution. Members were informed there would be a new Over- 55s Rinks competition in 2017.

During the election of Officers, M. Kilmister was appointed Assistant Secretary it being a position previously held by members. The Annual dinner was held again in Ponteland Golf Club.

At the 2017 Spring meeting, attended by 42 members, the President, G. Stapylton, announced that this is the 50<sup>th</sup> year of the Ladies' Section and hoped it would be made something special. The Secretary, E.J. Ramsay, reported on the winter programme of social events. fund- raising activities included the Beetle Drive organised by H. Furniss



for charity (£100) and a very successful Daft Dominoes event. The Burns' Night evening held in Ponteland Golf Club (£457). Thanks were extended to R. Varley for organising the Domino Drive (£188) and to S. Simmons with her team for the tea arrangements. C. Davison was thanked for organising the food with a glass of wine for the Quiz Night (£79). The annual pre-season dinner was held again in Ponteland Golf Club.

In connection with the league matches the Ladies' Committee decided to increase the charges for away matches from £3 to £4. Both J. Nixon and D.W. Kirk were thanked for their part in organising the Public Utilities League matches in recent years. Both E. French and D.C. Crozier would be responsible for the full programme in 2017. Members were reminded of the friendly matches and early season five Taster Sessions to encourage newcomers to the Club. Members were reminded that Opening Day would be on the 22<sup>nd</sup> April and tea would be held afterwards in PMH. The Green Ranger, W.R. Liddle, gave a short talk explaining the changes he was making on the direction of play to protect and preserve the green. Play will take place in each direction on a weekly basis.



Ladies' Section 50<sup>th</sup> Anniversary Tea Party  
8th September, 2017

At the 2017 AGM, attended by 42 members, G. Stapylton thanked all of the Committee members and others who had volunteered their help with various events and competitions during her Presidential year. She also emphasized the need for other members to voluntarily take on responsibilities on their Committees for the Ladies' Section to function. The Secretary E.J. Ramsay, reported on the very good attendance by the ladies on Opening Day and the excellent tea held afterwards in PMH. Mention was made of the well supported league and domestic competitions, and of the £250 grant from the BDA awarded to Clubs who actively encourage new members into bowling. Members were also informed of the Club and Tennis Club's joint success again in the "Northumbria In Bloom" competition having been awarded their fifth Gold Medal Certificate.

The Secretary mentioned a most memorable occasion in the Clubhouse when celebrating the 50<sup>th</sup> Anniversary of the Ladies' Section. The tea party was organised by the Social Committee and well attended by members and friends from both Sections. The event was opened by the Mayor of Ponteland, Cllr Alan Varley, alongside his wife Linda. Thanks were extended to all those who had helped G. Stapylton in organising a most interesting display of memorabilia. The sponsor of the event, Rington's Tea, was thanked for its generous donations of tea, coffee, biscuits and of the Rington's Hamper for the raffle. Special thanks were extended to Cynthia Davidson for her magnificently decorated fruit cake.

E. Cowings reported on the successful completion of the domestic competitions. Organising jointly the men's and ladies' events, however, had proved difficult as the men did not have their own Competition Committee in place at the beginning of the season. S.A. Storey presented the Selection Committee report by A. Rutter. In order to provide continuity of selection of members in the league matches, those who volunteer should consider it to be a commitment for the season. The Club won the North East Ladies' League and were presented with a cup and a cheque for £50 at their AGM. The GPC decided to purchase a replica trophy with the prize money. It was agreed that a reserve should attend league matches and that the matter be raised with the incoming Selection Committee.

At the 2018 Spring meeting, attended by 31 members, R. Twizell, the newly elected President, welcomed everybody to the meeting and thanked members for their continuing support of activities held during the winter months, and for a successful season.

The Secretary, E.J. Ramsay, reported on the social events during the past year. The monthly coffee mornings held throughout the winter raised £610 which should keep bus travel costs to £3 per person to away matches. Thanks were extended to the members who organised the winter activities and in particular, S. Barras and the Social Committee members for preparation of the food. Also, the efforts of non-Social Committee members were much appreciated. The activities included a Beetle Drive, Daft Dominoes, Burns' Night, Games Afternoon and Quiz Night. The total sum raised for the Club funds was £710. The £125 proceeds from the Beetle Drive were donated to the charity "Crisis At Christmas". Members were informed that prior commitments immediately after Opening Day meant the regular Collins & Shipley v. Clegg / Knight fixture would be held before official opening of the green on the 21st April. Both new and other occasional playing members were encouraged to participate in the Nan MacLeod competition and friendly matches throughout the season. Five Taster Sessions had been arranged for Saturday mornings during May/June. With a declining membership, the efforts of the Club Coaches in giving up of their time introducing the public to bowling is much appreciated. Thanks also extended to other members for their help in providing coffee, tea and biscuits throughout the morning sessions. M. Cowan, the County representative, provided details of BN Ladies' events.

At the 2018 AGM, attended by 33 members, the President, R. Twizell, expressed her thanks to all the Committee members and volunteers for their support with the events and competitions throughout a most enjoyable year. The Secretary, E.J. Ramsay, reported on the league and cup competitions. In what proved to be the best summer, possibly since 1976, the results were excellent with no need to reschedule league matches because of wet weather. The Club were winners of both the Collins & Shipley Division 1 and NEL leagues and came third in Collins & Shipley Division 2 league. Members were reminded that the selected reserve for a match should ensure they attend in Club uniform. Also, it may be necessary next year to increase slightly the £3 bus fare because of an anticipated rise in transport costs. It has remained at £3 for several years due to the successful winter coffee mornings. Unfortunately, as in recent years, the pre-arranged friendly matches received little support from members in both Sections. The GPC has decided to have more mixed friendly fixtures at the expense of some of those usually arranged for the Ladies' and Men's Sections.

Members were informed that the Ladies' Committee has decided that unclaimed or unwanted items of clothing which are left in the changing room at the end of the season will be removed and given to charity. The annual barbecue event took place in glorious June weather and raised £605 for Club funds. The annual Pie & Peas event has proved to be very popular and again was well supported.

Concerning community affairs, the Club was again awarded a BDA grant for its efforts in encouraging the public into playing bowls. Five Taster Sessions were held in May/June, also advertisements included in local publications and posters placed in various locations resulted in four ladies and six men joining the Club. Mention was made of the popular annual bowling Mayoral event with Ponteland Town Council and, prior to 2009, the former Castle Morpeth Borough Council. Members were appreciative of the food and wine provided afterwards in the Clubhouse by the Town Council. In September, the Club participated in the world's biggest Coffee Morning for Macmillan Nurses. The event was well supported with a Bring and Buy stall, Guess the Weight of a Cake competition and a Raffle. Thanks were extended to the helpers and supporters of the event which raised £260 for this worthy cause. In November, the end-of-season luncheon was held in Ponteland Golf Club. Finally, E.J. Ramsay, having served

for three years as Secretary, thanked everyone for the support received during her time in office. She remarked it had been a pleasure serving with President R. Twizell and was looking forward to next season as the newly elected President.

At the 2019 AGM, attended by 33 members, the President, E. J. Ramsay, warmly welcomed members to the meeting. In connection with the League matches she congratulated the teams on their very successful season. The domestic weekly Nan MacLeod Salver competition had had a rather disappointing turnout, also the L.H Loughton Cup 3-Bowl event which was not completed. Thanks were extended to all those who had helped her throughout the year and on closing wished the incoming President, O. Driver, a very successful year.

The Secretary, S.A. Storey, mentioned the variability of the weather, unlike that in 2018, which caused disruption of the season's league matches and friendly fixtures. It also brought about cancellation of some of the domestic competitions. She also spoke of the very successful results obtained in the league matches. Also, mention was made of the appointment of a travelling / home captain to assist the captain which proved successful. It was disappointing, however, not to have a sufficient number of reserves available for matches. The selection of players for matches depended upon several factors viz. the weather, compatibility with team members, current performance and personal development. Finally, members of the Selection Committee were thanked for their time and effort this year. Mention was made of the Beetle Drive which raised funds for the charity CRISIS. Another charity, MIND, benefited from funds raised at regular coffee mornings, afternoon teas, homemade crafts and stalls.

County representative, M. Cowan, reported that a second draft of the new BN constitution had been approved. M. Turner had retired from playing but was continuing as a selector. A grant of £500 had been obtained to introduce new County shirts. The Competition Secretary congratulated the PBC team on its successful season in winning the Collins & Shipley Division 1 title and the members participating in the National Finals at Royal Leamington Spa.

O. Driver reported that a combined Competitions Committee organised the programme. Unfortunately, unseasonable summer weather meant the cancellation of some competitions and social events. She expressed disappointment with the low registrations obtained for the Rainbow Trophy and the established Nan MacLeod Salver competitions. New members would benefit from the experience to be gained by participating in these competitions alongside more of the league players. Thanks were extended to members who had given up much of their time.

In connection with team selection, E. Cowings outlined the challenges faced by the Committee in having to re-schedule fixtures due to inclement weather. Also, the need to ensure members selected are able to play at the appropriate level and having strong teams able to win their league matches.

The 2020 programme of fixtures, social events and annual members' meetings were cancelled due to the outbreak of the extremely contagious Covid-19 virus.

At the 2021 AGM, attended by 20 members, E.J. Ramsay deputised for President, M. Kilmister. With the lifting of Covid-19 restrictions by the Government it was possible to have a full season of domestic competitions. Not all of the normal social activities were held but the introduction of new 'mixed' in-house competitions proved to be successful in bringing the Ladies' and Men's Sections together. Lastly, E.J. Ramsay passed on her good wishes to R. Rochester the incoming President.

The Secretary, S.A. Storey, mentioned the decision taken by the GPC, and by no means unanimous, to cancel league fixtures and County competitions, without calling an EGM to obtain the consent of members. Although social activities were severely

affected earlier in the season, the arrangement of picnic events later on proved popular. The Secretary was of the opinion that changes need to be made at the Club arising from events which occurred during the virus. In particular, ensuring better communication to members following decisions taken by the GPC. Also, the Club has a duty to look after all members relating to social gatherings and their participation in domestic events and friendly / league / County fixtures. Applications have been made to rejoin the Collins & Shipley and NEL leagues.

In connection with the Club competitions it was reported that only two members sat on the Committee. Changes had been made to several competitions which not everyone had agreed with. The established Nan MacLeod Salver weekly competition had received very little support, and members, therefore, agreed to reducing the minimum number required to participate in the event. Also, it was agreed to lower the entry age to Over 70s to encourage more participation in the Mary Little Trophy competition. The Pairs competition was re-arranged due to inclement weather but insufficient number of players were available to hold the event. There was no presentation of the Joyce Carmichael Memorial Cup as the Triples competition had ended with a triple tie. The Selection Committee met only once to select teams for the Double Rinks and Gosforth Centenary Plate which was won by PBC.

M. Cowan presented the County Report stating that the Club would be allowed to rejoin the Collins & Shipley league matches with both teams entered in Division 2. A proposal had been made for players to be allowed to wear open-toed sandals provided they accepted responsible for any injuries.

Following the election of Officers and Committees a lively discussion took place in connection with a member's suggestions for introducing new competitions. It was hoped they would encourage new members to participate in competitive matches and, more importantly, get to know other members and improve their own skills. It was agreed these ideas be considered by the Competitions Committee and for approval of the GPC.

At the 2022 AGM, attended by 38 members, the President, R. Rochester, welcomed everyone to the meeting and expressed her thanks to her Committee members. She mentioned providing encouragement to new members and how not to give up but to enjoy playing at whatever level suited them. The President referred to several events held during the year viz. The Queen's Platinum Jubilee, Bowls Northumberland County Presidents' Day and over £1,000 being raised for Alzheimer's Newcastle UK. Mention was made of the return to league matches and only missing out by 1 point to gain promotion in the Collins and Shipley competition. The President then passed on her good wishes to S.A. Storey the incoming President.

The Secretary, P. Varley, presented her report on what had proved to be a very full calendar year particularly for members attending for the first time. The usual winter events had taken place with the coffee mornings raising £515 for the Club's funds. The Secretary was pleased the Ladies' pre-season luncheon had got the year back on track after a gloomy couple of years. She mentioned the Spring meeting and that all members will receive forms advising of competitions. Now, having a healthy membership she was looking forward to welcoming many of them into the teams. Concerning the away fixtures it was decided that cars should be used as transport costs were too costly. The Secretary expressed thanks to both the Committee members and helpers at whatever level, and extended a very warm welcome to S.A. Storey the incoming President.

The Competition report was presented by A. Pearson who thanked all the organisers of the many competitions run throughout the year. Reference was made to the Nan MacLeod competition in which 29 ladies competed this year. However, only eight ladies had played on six or more occasions and they alone were eligible to win the trophy. It was pointed out that issues had occurred with some members playing in the

domestic competitions and not understanding fully the rules concerning late games and the right to a walkover.

On presenting the Selection Committee report R. Twizell outlined its main task being the selection of teams to participate in league matches. Also, the opportunity was taken with friendly fixtures to include some of the newly recruited members. At times, difficult decisions are taken when selecting players more suited to the condition of a bowling green. She also mentioned both A. Rutter and J. Pringle were invaluable for making observations concerning the games and assuming responsibility of Captain for the day together with G. Stapylton. On closing, R. Twizell reminded the meeting that those helping the Committee do so voluntarily and any comments or input should be respectful of the effort made in these tasks.

M. Cowan presented the County report which was of particular interest having S.A. Storey as the County President and five members representing PBC in the County matches.

Following the election of Officers and Committee members the 100 Club Draw was made by the Treasurer, J. Barras. It would appear from a query raised at the meeting that there was little awareness of the donors of the Club's domestic trophies. This information, however, is shown in Sections 11.1 and 11.2 of this narrative.

The following table indicates the decline in membership in recent years but, as in the case of the Men's Section, showing signs of significant improvement post- Covid-19 attributable to the energy and enthusiasm of the GPC and newly elected members.

**PBC Ladies' Membership, (2001 - 2023)**

Year	Full	New	Associate	Social	TOTAL
2001	65	31	3	-	99
2003	95	4	2	-	101
2005	89	2	4	-	95
2006	82	4	6	-	92
2007	81	2	5	-	88
2008	82	8	3	-	93
2009	79	1	5	-	85
2010	70	2	7	-	79
2011	68	7	7	-	82
2012	72	2	11	-	85
2013	68	?	13	-	81
2014	72	?	11	3	86
2015	69	?	11	4	84
2016	70	?	11	4	85
2017	73	?	9	7	89
2018	60	4	14	4	82
2019	58	?	7	14	79
2020	43	?	7	?	50
2021	45	?	?	?	45
2022	39	20	6	4	69
2023	56	11	6	9	82

### **1.3 Combined Sections**

In general, matters raised at the AGMs relating to the bowling green and the Pavilion are reported separately in Sections 7 and 8 respectively.

At the 1999 AGM, attended by 72 members, amendments to the draft Constitution, previously circulated to members, were discussed and any lady member elected as Chairman would be addressed as Lady Chairman. Concerning the election of Officers and Committee members at the first Combined AGM in 1999, two Past Presidents of the Men's Section, R.B. Baxter and B.D.W. Wright, were nominated for the position of Club Chairman, an office last held in 1954. Following the result of the ballot, R.B. Baxter was declared the Club Chairman, and both A. Wilson and E.W. Lowthian were elected unopposed as Secretary and Treasurer respectively.

At the 2000 AGM the proposed new Rules and Constitution were approved by the members. The total membership was set at 200 and comprised of 100 men and 100 ladies. Past Presidents of the Club, Mrs M.E.H. Nesbit and R. Stafford, were nominated for the position of Club Chairman. Following the result of the ballot, Mrs M.E.H. Nesbit was declared Lady Chairman for the next three years. Following some favourable discussion it was decided that consideration be given to providing Clubhouse facilities able to accommodate such a large membership. As a result of the welcome change in the Constitution, it was suggested that a joint Presidents' Day be held in future.

In April 2001, the pre-season dinner which was followed by entertainment, was held in Newcastle Airport Britannia Hotel. In May 2001, the Club was represented at the Methodist Church Festival.

At the 2001 Annual General Meeting, attended by 62 members, Secretary, A. Wilson, said that in connection with the Club Rules he had received a proposal from two members requesting that former members, previously residing outside the permitted residential area i.e. 3.5 miles radius from PMH, be allowed to re-join the Club at a later date. With the recent re-enforcement of the residential limit of 3.5 miles radius by PMH Trustees this was not possible. It was noted that the NLC had imposed a condition of open membership in order to receive funding. However, after some discussion, a vote was taken on the proposal by a show of hands with 16 in favour and 13 against. There were 33 abstentions compared with the 29 members interested enough to vote on this issue. It was announced that H. Robson had been appointed the official County Coach.

In February 2002, the GPC considered a proposal by G. Goldie for possible issue to members, regarding etiquette on the green. However, the Committee considered the well-meaning statement was unnecessary. In April 2002, the pre-season dinner was held in the Newcastle Airport Britannia Hotel. With the need to raise funding to replace the Pavilion, the Social Committee began in earnest to organise a series of events which could be staged in future years. The first-ever Chinese Evening was held in the New Rendezvous restaurant (£662), a Bridge Drive was held in PMH (£531) and an innovative quiz, organised by Mrs M. Bryson (£100). The PMH Committee increased the bowling green rental by 41%, from £390 to £550.

On the 3rd June 2002, a day which was rather damp but brightened up later, the Club celebrated the Queen's Golden Jubilee with a splendidly organised Jumbles. A charge of £5 was made to cover the provision of both tea and a raffle ticket. Also, members participated in an excellent hat competition which was won by J. Nichol with her hand-made crown. To mark the centenary of the EBA in 2003, affiliated Clubs were requested to donate £10 to the NSPCC charity which met with the agreement of the GPC.

At the 2002 AGM, attended by 52 members, the Treasurer, R. J. Varley, explained in detail the Statement of Accounts and of the need later on to increase the annual subscription if the proposed Clubhouse was built. Also, he outlined the legal position of the Club with regard to PMH-a registered charity. The Charity Commissioners had raised objections to the grant of a lease which was required for the Club's security of tenure but was a condition of the £30,000 grant requested from the Foundation for Sports and Arts. This seemed to be an unnecessary complication as PMH, the bowling green and the tennis courts are the memorial to the servicemen from the Ponteland area that lost their lives in World War I, and a lease was not required. Meanwhile, G. Webb stated that Dickinson Associates of Morpeth had been engaged in an advisory role and had obtained estimates ranging from £186,000 to £129,000 from local builders for the new Clubhouse. In addition, Dickinson Associates were to be paid £3,500 + VAT. Members would have to decide on proceeding with the project by the end of November to ensure its completion before Opening Day in 2003. Regarding the condition of the bowling green and its surrounds, G. Webb thanked R. Stafford, W. Bell and members of the Green's Committee for their efforts throughout the season.

Concerning the proposed indoor bowling green facility at West Denton it was confirmed that G. Goldie was a member of the Committee. Prospective members from Ponteland were asked to show their support of the venture by making a small monetary contribution, as required by the Lottery Authorities.

It was reported at a GPC meeting, held shortly afterwards, that A. Ridley, a new member, was designing a website for the Club which would provide information relating to the social calendar including photographs, fixtures and the achievements of its members in both domestic and County competitions including representative honours.

The Chairman thanked Mrs A. Rutter for her report on the events covered by the Social Committee and their excellent catering arrangements. R. Stafford in his final report and 18 years as Green Ranger, commented on the excellent condition of the green and of the necessary maintenance work described in Section 7. He was pleased to see the great improvement in its playing condition and *'had enjoyed every minute of it even when cutting the grass at six o'clock in the morning, and using the old sprinkler system of watering which kept him there 'til midnight. It had never been a chore.'* In recognition of his long and devoted service to the Club he was made an Honorary Vice President and presented with two boxes of wine and wine glasses. Mrs M. Richardson presented his wife, Brenda, an Associate Member, with a basket of flowers.

In April 2003, the pre-season dinner was held in Newcastle Airport Britannia Hotel which raised £147, and a Bridge Afternoon which raised £100. Regarding PBC fixtures for 2003, it was decided to withdraw from the NEEPCL after 28 years in the competition. In recent years, there had been difficulty in finding members willing to play in the previously popular fixtures of the first white-dress league competition in the North East. During the season, the following revenue-raising events were held viz. an excellent barbecue held beside the green (£610), a Chinese Evening held in the New Rendezvous restaurant (£462), a Bridge Drive (£460). M. Cowan of the Ladies' Section participated in a sponsored walk for Club funds (£365) her efforts being much appreciated by the members. Regarding these Clubhouse revenue-raising activities, several members had, in no small measure, provided much practical assistance. The GPC expressed its gratitude to the Social Committee and especially to Mrs E. French who raised £500 from among the members towards the cost of tables & chairs. The GPC also mentioned the many DIY jobs, in and around the Clubhouse, which were carried out by W.R. Liddle with the able assistance of other members including G.D. Bennett, E.W. Lowthian and R.A. Peckham.



**The Queen's Golden Jubilee organisers : Betty and John Nesbit**



**The Queen's Golden Jubilee : PBC Celebrations, June 2002**

**(l - r) : Mesdames F. McDonald, J. Cosby and H. Furniss, C. Bryson, K. Griffiths, Mesdames E. Emmerson, B. Stafford, ? , F. Owen, E. French, E. Trimble, ? and ? , J. Lunn, K. Hunter, L. Crofts, N. Green, P. Telfer, Mrs D. Crofts, G.D. Bennett, Mesdames L. Telfer, D. Green and J. Trimble, E. Caldwell, Mesdames M. Tailford and M. Lowthian, E.W. Lowthian, J.W. Nesbit, Mesdames M. Cowan and M.E.H. Nesbit, P. Cordingley, Mrs J. Smith, D. White, Mrs L. Porritt, ? , Mesdames N. Caldwell (President), M. Williamson and M. Catchpole, A. Mahmood, Mrs M. Bryson, G. Skinner, A.O. Christie (President), Mrs J. Marshall and E. Scholes**





**The Queen's Golden Jubilee Anniversary Jumbles, 2002**

At a meeting of the GPC in January 2004 the fixtures for the new season were discussed and F. Knight kindly offered to provide a list in booklet form rather than the A4 sheets. In April 2004, the pre-season dinner was held again in Newcastle Airport Britannia Hotel. Following the success of the previous barbecue, another was held in August 2004 which raised £500. This popular function, however, can accommodate no more than 120 persons around the green. Altogether, £4,251 was raised from the various functions including the coffee mornings. In keeping with the new Clubhouse it was decided to provide new Honours Boards dating back to the formation of the Ladies' Section in 1967. These were purchased at a cost of £1,789. The Australia resident family of the late Gordon Skinner donated £211 covering the cost of a Memorial Board listing the names of Club Officers.

At the 2004 AGM, attended by 58 members, the Treasurer reported that all of the 3-year loans secured for the Pavilion project had been repaid. Some of the 5-year loans would be repaid early in 2005 and the remainder in 2006. Annual repayments of the interest-free EBA loan of £20,000 would be completed in 2009. Necessary insurance for the Club covering Buildings, Contents, Employers' and Public Liability was obtained at a cost of £640. There was a small increase in the rental payable to PMH. In response to an appeal, a donation was sent to the Blind Bowling Association.

Early in 2005, a successful pre-season dinner was held in Kirkley Hall and further revenue-raising events were arranged by the Social Committee viz. a Bridge Evening (£440), Domino Drive (£693), barbecue (£538), and a Jumbles event followed by a Fish & Chip Supper (£462). Altogether £5,900 was raised from the various social events and coffee mornings, including £330 from the all-day Mixed Pairs competition.

At the 2005 AGM members agreed with the recommendation of the Treasurer that the annual subscription be increased from £75 to £80, no increase having taken place since 2000. In connection with the Club Rules, the GPC considered it was desirable to allow it to exercise its discretion should membership levels fall below the maximum of 100 in either Section. It was intended this should only take effect when an imbalance of not more than five vacancies occur in either the Ladies' or Men's Sections. It would offset the need to raise annual subscriptions to retain the budgeted level of income. However, the proposal by the GPC was defeated. The decision taken in recent years, to

replace Officers and Committee members after a 3-year period, had caused problems in the past. At this meeting, the problem re-surfaced when endeavouring to appoint a new Treasurer. In the ensuing discussion, an opinion was expressed that muddled thinking had led to willing and most capable members having to stand down at the election of Officers. In order to resolve the impasse, it was decided that the Treasurer be allowed to continue for another year, albeit a further infringement of Club Rules. Thanks were extended to members of the Social Committee for their excellent teamwork in providing catering arrangements for matches and social events. It was reported that the recently donated computer had been installed in the Club Office for use by members but was without an internet connection.

Following the meeting, A. Ridley gave a presentation on the content of his proposed website for the Club. The Chairman, A.O. Christie, thanked him for setting up the website which would provide members with coverage of activities including various social events.

In December 2005, the GPC agreed that No Smoking notices be displayed around the green. This reinforced the decision taken in 1992 to prohibit smoking in the Pavilion.

In January 2006, another very successful Chinese Charity Evening was held in the New Rendezvous restaurant raising £742. In April 2006, the pre-season dinner with musical entertainment was held in Ponteland Golf Club. Other revenue-raising events included the popular Fish & Chip Supper (£170) and a well-attended barbecue (£550). In the following month, Dominoes with a Difference was held in the Clubhouse (£210) and two Whist Drives (£600). It was agreed that a Bridge School for beginners be held in the Clubhouse during the winter months. The GPC agreed to donate £50 to the NCBA Charitable Trust and the proceeds from the Spider Competition on Presidents' Day would be sent to the English National Association of Visually Handicapped Bowlers. In connection with the domestic competitions E.W. Lowthian was appointed Competitions Chairperson. Concerning the ladies' County competitions, the GPC also decided that £30 each from Club funds be awarded to Mesdames E. French and D. Walwyn-James who attended the National Pairs Finals at Royal Leamington Spa.

At the 2006 AGM the Treasurer reported that fund-raising events had raised £5,876 and that the annual subscription for 2007/2008 would remain at £80. In connection with the election of Officers, members were reminded that a new Treasurer would be needed for 2007 when R.J. Varley would be President of the Men's Section. Following the results of two secret ballots, the Green Ranger replaced the Chairman of the Green's Committee on the GPC and the capital expenditure limit of £1,500 previously agreed for the GPC was increased to £5,000. Members of the Social Committee were warmly thanked for their efforts throughout the year. The County Coach, W.R. Liddle, drew attention to the English Bowls Coaching Scheme for any member who may be interested in coaching. Application forms were available for attendance at a course which would be run over several weeks and includes a final examination. It was mentioned that three nice youngsters had joined the Club as Junior members. After the meeting, A. Ridley again presented a comprehensive update of the Club's website. It included showing photographs of several social events, league results and the results of members' domestic competitions in 2006. He was warmly thanked by the Chairman for his efforts in recording the Club's activities. The GPC wish to record their thanks to M. McDonnell for his willingness to carry out much of the cost-saving maintenance work in the Clubhouse.

In April 2007, the pre-season dinner was held in Ponteland Golf Club. An EGM was also held in April 2007 to discuss the proposed new Constitution and amendments to the Club Rules. The revised Constitution did not materially change from the original and the Men's President, J.T. Harrison, explained the need to make minor changes as there was scope for re-organization and simplification. Following on from the discussion, a secret ballot was held with only one-third of the Club's membership

taking part. The proposed changes, however, were approved by a substantial majority. Afterwards, Mrs E. French gave a presentation on the opportunities provided by the Club, viz. community fellowship, training, no geographical restrictions, no age barrier, sex equality, under-35 automatic entry, support of junior entry, availability of the green to non-members and a welcome to all, especially ethnic minorities. The proposed new Rules for both Ladies' and Men's Sections were approved by a substantial majority. The Chairman, A.O. Christie, thanked both Mrs E. French and J.T. Harrison for their excellent presentations of the new Constitution and Rules. Other members were thanked for their commitment in preparing the two documents and particularly R.G. Brown on the legal aspects under constitutional law. In other matters raised, it was stated that smoking outside the Clubhouse was still allowed.

At the 2007 AGM, attended by 66 members, the Treasurer reported that social functions were again very successful (£5,529) and that the annual subscription would remain at £80. An entrance fee of £80 was introduced and a charge of £2 would be payable by visitors for casual play. Associate membership was discussed following a letter received by the GPC from B.D.W. Wright who considered that the annual subscription of £25 was inappropriate, particularly for members of long-standing and unable to play regularly- if at all, for health reasons. When first introduced at the 1981 AGM of the Men's Section, and reported elsewhere in this narrative, no fee was payable and, in the light of this information, it was agreed the fee be reduced to £10. With respect to the Constitution, members agreed with the following dissolution clause :

*“After discharging all debts and liabilities of the Club the remaining assets shall be passed to the Trustees of Ponteland Memorial Hall without any personal liability accruing to any members of Ponteland Bowling Club. In the event that the Ponteland Memorial Hall becomes insolvent before the demise of the Club any net assets will be given to Ponteland for the benefit of amateur sport within the Parish.”*

An EGM was held in the Clubhouse in May 2008 for the purpose of updating members on the possible extension of the Clubhouse together with landscaping of the waste ground in the south-west corner of the site. G. Webb gave details of the proposed extension to provide additional space in the changing rooms and the main hall. J.T. Harrison explained the four sources of funding that were possible. The GPC wished to obtain favourable views from the membership on the proposed projects and to obtain their agreement in its pursuit of the necessary funding. Andrew Tunnah from CMBC addressed the meeting concerning available funding and stated that he would assist Club Officers with the application forms. The following proposal was put before the members and met with their approval :

*“The GPC proceed with the various tasks required and incur necessary expenditure to enable us to apply for funding to extend the Clubhouse and landscape the unused ground at the side of the site.”*

Following the meeting, A. Ridley again produced a comprehensive coverage of the Club's activities during the 2007 season which was set to appropriate music. Copies of the compact disk were available at the minimum cost of £2 or a donation. He was warmly thanked by the Chairman for his efforts in placing recent activities on the website.

At the 2008 AGM, attended by 65 members, J.T. Harrison reported that the proposed 4m. extension of the Clubhouse could go ahead. Applications to CMBC for a grant of £31,640 from the “Extra Mile” fund and to Bowls England for a £10,000 loan were successful. He thanked seven guarantors from the GPC for their support. Chartered Surveyors, Joe Dickinson Associates, were originally employed when the Clubhouse was built in 2003. They had been engaged again to draw up plans, liaise with builders for quotations and provide a detailed specification for the local planning

authority. The Treasurer then discussed the projected five-month timescale for its completion in time for Opening Day in April 2009. Reference was made to the waste land at the south-west corner of the site which could be utilised for outdoor social occasions. A grant application to "Sports For All" for £10,000 would be made. The Financial Statement was discussed and members were thanked for their efforts in both organising and participating in various social functions throughout the year. Thanks were extended to A.D. Barritt for scrutinising and verifying the Accounts. The Chairman, A.O. Christie, warmly thanked the Treasurer for both his hard work and dedication on behalf of the Club.



**Presidents, July 2005**

**(l - r) : M. Cassie, M.E.H. Nesbit, J. Nichol, E. Donkin, C. Cobbing, M. Cowan (President), J. Cosby, B. Johnston, M. Owen, M. Healy, N. Caldwell, L. Telfer**



**Presidents, July 2005**

**(l - r) : P. Telfer, J.S. Duff, B.D.W. Wright, E.W. Lowthian (President), R. Elder, G. Goldie, K. Griffiths**



**Presidents' Day, July 2006**

**Standing (l - r) : Mrs L. Porritt, J.T. Harrison, T.N. Robson, E. Scholes, A. Mahmood, Mrs J. Marshall, C. Bryson, R. Stafford, J. Smith, Mrs M. Brown, J. Smith, E. Caldwell, P. Telfer, Mrs N. Caldwell, J. Burn, A.O. Christie, M.L. Brennan, Mrs J. Cosby, M. McDonnell, Mesdames M. Williamson and M. Healy, A. Wilson, Mesdames A. Carr and D. Green, H. Robson (President), K. Harrison, Mesdames B. Johnston and B. Stafford, E.W. Lowthian, J. Waller, F. Marshall, Mesdames M. Tunnah and M.E.H. Nesbit, N. Green, Mrs S.M. Ridley, G. Warner, Mesdames H. Waddell and D. Walwyn-James, H. Porritt, Mesdames E. Donkin, M. Catchpole, A. Rutter and A. Lowe, R. Donkin, Mesdames M. Knight and W. Olds, A. Ridley, D. Carr, Mrs M. Lowthian and L. Danby**

**Front Row (l - r) : Mesdames L. Telfer, L. Harrison, E. French, D.A. McDonnell (President), M. Bryson, E. Emmerson and J. Marshall**

Following his first year as Green Ranger, D.W. Kirk, presented a very detailed report on events relating to adverse weather conditions during the season. Details are presented in Section 7. Thanks were extended to members of the Green's Committee and R. Stafford for their support, and also his assistant green-keeper, C. Moore, Aaron, and W. Bell for keeping the grass surrounds in such good order. The Chairman thanked D.W. Kirk for his excellent work despite the difficult weather conditions.

Mrs A. Rutter in her report on Social Committee activities thanked all the members who had contributed in making a success of the catering arrangements during a very busy season. She also thanked those who helped with routine tasks including laundering tablecloths, tea towels and cleaning of teapots.

Following his election as the new Chairman, R.J. Varley thanked A.O. Christie for an excellent three years whilst in office and for his wit and quiet control of meetings and events.

In November 2008, an exhibition organised by J. Turner, Chairman of Ponteland Local History Society, was held in PMH to celebrate its 40<sup>th</sup> anniversary. The Opening Ceremony was performed by the last Mayor of CMBC, Cllr Irene Brumwell, prior to the inception of the unitary authority Northumberland County Council. Participants in the Community History Day exhibition included churches, schools, societies and local clubs. A. Ridley and B.D.W. Wright on behalf of the Club presented a history using several exhibits including a series of photographs covering the period 1923 - 2008.



**PBC Display at Community History Day Exhibition, 1<sup>st</sup> November, 2008**



**PBC Presenter, Bernard Wright, with CMBC Mayor Cllr Irene Brumwell**

In March 2009, the GPC congratulated J.T. Harrison on being presented with the Castle Morpeth Sports Award Certificate of Achievement for his efforts on the Clubhouse extension. In April 2009, the pre-season dinner was held in Ponteland Golf Club. In September 2009, the Club were runners-up in a Mixed Rink charity event for Asthma Relief held in Parks B.C. Also, in September, Ms S.A. Storey a retired headmistress, was appointed Child Protection Officer with full CRB clearance through Bowls England.

At the 2009 AGM, attended by 64 members, the Chairman, R.J. Varley, welcomed members to the first meeting to be held in the Clubhouse and commented on the excellent facilities that were available for many years to come. The Treasurer, J.T. Harrison, reported on the work involved in completing both the extension to the Clubhouse and the patio area, details of which are given in Sections 8 and 7 respectively. He expressed his gratitude to G. Webb for his efforts as Project Manager on the completion of the Clubhouse extension. Also, he thanked members who had helped both J. and Mrs E. Gatenby in establishing the rock garden. The John English Memorial Garden bequest of £500 had been used to provide plants and a plaque, made by R.I. Shuttleworth, for placement in the garden and was shown to the members. In connection with the Statement of Accounts the Treasurer reported that subscriptions were down £2,000 on 2008 there being 25 resignations, seven new members and three applications pending. He considered future membership would stabilise at 150. He thanked those responsible for several revenue-raising efforts, viz. Mrs E. Shuttleworth for organising her Open Garden event (£77), the Ladies' Section coffee mornings (£420), both Mrs M. Catchpole and E.W. Lowthian for proposing and running a Club Lottery (£500), also an anonymous donation for garden plants (£50). Despite the falling membership, he considered the income from in-house-letting from groups using the Clubhouse during the winter months and the full support of members attending events on the social calendar, the Club's finances would remain in a healthy state. The Chairman expressed his thanks to the Treasurer for all his efforts on behalf of the Club.

Mrs A. Rutter presented a comprehensive report on the various social activities throughout the season and thanked those members who had helped in organising the successful events. The Chairman thanked her for the excellent contribution that she had made during her three-year term on the Social Committee.

In connection with the domestic mixed competitions, the GPC decided to submit the following proposal to the members which was agreed and passed unanimously :

*“Due to the lack of support over the last few years, it is proposed that the two competitions, viz. the Harry Emery Mixed Pairs and the Stan Wright Mixed Triples be combined into one competition and called the Emery / Wright competition.”*

E.W. Lowthian drew members' attention to the Curling Stones competition to be held shortly in the Clubhouse. The equipment was freely made available by the West Denton Association. Before closing the meeting, R.J. Varley said that he had the extremely pleasant task of thanking Billy Bell for the fantastic work he had carried out over many years in keeping the green surrounds in good condition. Endorsing his comments, the Treasurer mentioned the unforeseen work he carried out. The Chairman then presented him with his favourite 'tipple'.

In April 2010, the pre-season dinner was held in Ponteland Golf Club. At the 2010 AGM, attended by 57 members, the Treasurer reported a balance of £7,697 with £14,247 in the combined bank Accounts. However, on the debit side there was an ongoing repayment of the Bowls England loan of £10,150 and the need to replace the main mowing machine within 2 or 3 years. Extra efforts on coaching led to 15 new members, although the total subscription was down slightly due to there being four fewer members overall. The current membership was 164. The social functions were very successful raising £3,565. The Art Groups and Decoupage classes who use the

Clubhouse during the winter months donated £555. The main Clubhouse expenditure had been the installation of a new central heating boiler at a cost of £1,043. The Green Ranger reported that the police had been called on two occasions due to a break-in that occurred in a shed and some damage to the green and chairs. The members agreed that the GPC can proceed with the purchase of a new mowing machine should the cost exceed 35% of the total subscription.

The Chairman thanked Mrs R. Johnson and members of the Social Committee for their excellent efforts with catering arrangements for the various matches and social events throughout the year during the period when D.A. McDonnell was Lady President of Bowls Northumberland. A discussion on dress code followed and it was agreed that whites would be worn on Opening, Closing and Presidents' Days also the Competition Finals. Further discussion ensued regarding the entrance fee of £80. Members were informed that Ponteland were the only Club in the County to impose such a fee. With the decline in membership and no persons on the Waiting Lists it was decided the fee should remain at £80 but would be reviewed at the 2012 AGM. It was pointed out that both the Leamington and Summerhill Clubs had closed due to lack of membership. The demise of Summerhill was a rather disturbing event. It was founded in 1916 as a private club and enjoyed a very large membership having the use of two bowling greens which belonged to West End B.C. It may be of interest to note that the much celebrated Dr W.G. Grace of cricketing fame and first President of the EBA (1903-1905) also played there when he captained England in a Home Series match against Scotland.

Perhaps, of local interest, Jackie Milburn and Len Shackelton who were both from Newcastle Utd F.C. also played at Summerhill B.C.

D.W. Kirk and J. D. Cowings attended a BDA meeting, held in Parks B.C., to discuss the Club's future coaching arrangements. It was decided sessions would take place during a six-week period beginning in April 2011. In October 2011, the President, J.D. Cowings, presented the Club with a set of junior bowls. The pre-season dinner was held again in Ponteland Golf Club.



Dr W. G. Grace  
*Courtesy of Newcastle Chronicle*

At the 2011 AGM, attended by 60 members, the Treasurer read out a letter from the widow of former member, Cecil Nicholson, who had passed away aged 105. She had donated £200 to the Club in his memory and as an acknowledgement of his long and very happy association with the Club. The legacy would be used to purchase some junior bowls. He then reported that overall the finances are now in a healthy situation. However, repayment still had to be made on the Bowls England loan, now reduced to £7,250. Replacing the Dennis grass-cutting machine (purchased in 2004) with an identical model would cost in the region of £5,500 in addition to other costs incurred on regular green maintenance work. Club functions had raised £3,328 and donations of £1,072 received from users of the Clubhouse during the winter months greatly assisted in maintaining members' subscriptions at £80. A grant of £350 had been received from the BDA which was used to purchase a video camera to help with coaching activities. With membership being well down on the 200 that was seen when the Clubhouse was opened in 2003, it was considered that the entrance fee of £80 had been a deterrent to prospective members. Following some discussion on the subject,



the proposal by the Treasurer that there be no entrance fee for 2012 was approved by the members. In August 2011, the Green Ranger, D.W. Kirk, had tendered his resignation following unjustified criticism concerning the condition of the green which had been adversely affected by the previously dreadful winter weather. W.R. Liddle would be provided with a job-description of the tasks involved but the Green Ranger would, however, only be responsible for work in connection with the bowling green. The Green's Committee and others would undertake supportive work around its surrounds.



**Presidents, July 2009**

**(l - r) : Mesdames J. Trimble and M. Richardson, E. Scholes, Mrs L. Telfer, P. Telfer, H. Robson (President), Mesdames D. Green, J. Nichol, D.A. McDonnell and M. Brown (President), E.W. Lowthian, Mesdames M. Cowan and M. Bryson, J.T. Harrison, Mrs C. Cobbing, A.O. Christie and Mrs M.E.H. Nesbit**



**Presidents' Day, July 2009**

**(l - r) : N. Green, G. Lowe, Mrs A. Lowe, C. Bryson, M. McDonnell, A. Mahmood, H. Howell, Mesdames J. Howell and C. Cobbing, D.G. Kennerley, Mesdames M. Taylor, M. Catchpole, S.A. Storey, M. Cowan, M.E.H. Nesbit, M. Robinson, J.T. Harrison, F. Knight, Mrs E. Gatenby, E.W. Lowthian, Mrs J. Marshall, G. Brown, P. Telfer, M.L. Brennan, Mesdames L. Harrison and J. Nichol, J. Gatenby, A.O. Christie, Mesdames M. Brown (President), L. Telfer and W. Olds, H. Robson (President), D.W. Kirk, Mrs D. Green, D. Carr, Mesdames S. Smith and M. Richardson, C. Titman, Mrs D.A. McDonnell, E. Scholes, Mesdames E. Trimble and R. Johnson, J. Waller, Mesdames J. Dineen, E. Emmerson, A. Rutter, M. Gibson, J. Trimble and M. Bryson, R. Smith**

Concerning social functions, Mrs R. Johnson reported that the following events had been arranged and were very well supported : Bridge, Quiz and Curry Nights, Pie and Peas Supper, two County events, Dominoes with a Difference, Chinese Evening and a Domino Drive held in PMH. Thanks were expressed to members of the Social Committee and others who had contributed to the success of these events. At the end of the meeting, the newly elected Lady Chairman, N. Caldwell, was pleased to announce the GPC had recommended that Mrs M.E.H. Nesbit, who joined the Club in 1986, should be the first lady nominated as an Honorary Vice President. The award recognized the many responsible positions held and functions she had organised for the benefit of the Club. Everyone agreed with the GPC proposal that she should be presented with the HVP badge for which she expressed her grateful thanks.



**Opening Day, April 2011**

**Back Row (l - r) : J. Gatenby, A.O. Christie, C. Titman, Mrs W. Olds, D. Hepplewhite, Mesdames D. Green and J. Dineen, J.D. Cowings, Mrs P. Haylock , M.L. Brennan, Mesdames E. Gatenby and N. Caldwell, D.W. Kirk, R.I. Shuttleworth, E.W. Lowthian, Mesdames I. Young, R. Twizell, E. Cowings, L. Harrison and M. Robinson, F. Knight, M. Anderson, D. Franks, D.G. Kennerley, N. Green, Mrs ? J. Waller, Mesdames J. Nichol and D. Walwyn-James, J.T. Harrison**

**Front Row (l - r) : Mrs J. Marshall, P. Telfer, Mesdames P. Varley and J. Smith, C. Bryson, Mesdames J. Turner, C. Davison, S.A. Storey, M. Catchpole, M. Richardson, E. Emmerson, S. Smith and D.A. McDonnell, A. Mahmood, J. Smith, D. Downing, E. Scholes, Mrs L. Telfer, M. McDonnell, Mesdames A. Rutter and ?, A. Jackson, Mesdames I. Eden, and C. Donachey, A. Ridley, . Mrs M. Bryson, L. Danby , Mrs A. Carr and R.J. Varley**

The GPC reported in January 2012 that the Club was encouraged to apply for Bowls Club Mark status qualification (Sports Council) by BDA. The procedures and standards had been achieved and would prove useful when applying for grants. Now that the website is well established it was considered that a development group of four members for future activities should be set up to assist A. Ridley. In April 2012, the pre-season dinner was held in Ponteland Golf Club. The Spider Competition held on Opening Day raised £55 for World Blind Bowls. Further to the history exhibition held in PMH in 2008, a similar Community Exhibition, hosted by Ponteland Town Council, was held on 2<sup>nd</sup>- 5<sup>th</sup> June to celebrate the Queen's Diamond Jubilee. The proceedings were opened by the Town Mayor, Cllr Peter Cowey, who congratulated those responsible for

organising the displays. The Club's exhibits were again presented by B.D.W. Wright and A. Ridley who provided a laptop demonstration of the content of the PBC website.

The GPC congratulated Mesdames E. Gatenby and S.A. Storey on completing their coaching examinations. In December 2012, the GPC decided that there would be no further commemorative plaques or spreading of deceased members' ashes in the new shrubbery garden. It was also announced that G. Stapylton would become the ladies' Vice President of BN in 2013.



PBC Stand at the Queen's Diamond Jubilee Celebrations, June 2<sup>nd</sup> - 5<sup>th</sup>, 2012



PBC Presenters, Bernard Wright and Alan Ridley, 2012



**The Queen's Diamond Jubilee Gala Day Celebrations, 2<sup>nd</sup> June, 2012**



**The Queen's Diamond Jubilee Gala Day Celebrations, 2<sup>nd</sup> June, 2012**

At the 2012 AGM, attended by 56 members, Lady Chairman, Mrs N. Caldwell, particularly welcomed several members at the meeting who had joined the Club during the summer months. The Treasurer, J.T. Harrison, reported that the arrival of eighteen new members had increased the membership to 77 ladies and 88 men. Summarising the main points of the Accounts he stated that there was a deficit of

£2,378 (Income of £24,048 and expenditure £26,426). The main items of expenditure had been the purchase of a new Dennis machine for £5,500 and the repayment of £3,250 on the Bowls England loan reducing the debt to £4,000. Several social functions raised £3,200 and there were in total donations of £1,717 from users of the Clubhouse premises during the winter months. There was a balance of £12,300 in the Accounts. The £500 Club Lottery which was set up in 2010 was no longer viable due to lack of support by members. It has been replaced by a 10-monthly 100 Club Draw organised jointly by Ms S.A. Storey and D.C. Crozier. PMH had increased the Club's fees due to User Group activities in the Clubhouse and having more use of its car park. The Treasurer concluded his report by saying he hoped the income from social events would be maintained at the current level because the running costs per member had increased by nearly 50% during the period 2006 to 2012. In view of this, the Lady Chairman proposed the annual subscription be increased by £10 to £90 which was approved by the members present. However, in order to attract more members it was unanimously agreed not to impose payment of an entrance fee in 2013. Members were informed that the GPC were giving consideration to purchasing an aerator machine which should greatly improve the green and save on the cost of hollow tining every two years. The trial period with an aerator machine had proved it would be a worthwhile investment for the Club. Although it will cost about £6,000 it was hoped a grant could be obtained towards its purchase. Under the Rules of the Constitution the GPC needed the agreement of members for any items exceeding 35% of the total subscriptions. However, the members agreed almost unanimously to proceed with the purchase without calling for an EGM.

The Green Ranger, W.R. Liddle, gave a detailed report on work carried out during the season and of his plans for maintenance work during the closed season. Members were shown the recently purchased green markers. In his closing remarks, he thanked all those who had advised him during his first full season of working on the bowling green. J. Gatenby spoke on behalf of the Green's Committee about their achievement in being awarded a Gold Medal Certificate in the "Northumbria In Bloom" competition. Mrs M. Cowan, read a report, prepared by Mrs R. Johnson, on various social events, similar to those in 2011, which included Bridge, Quiz and Curry nights, a Pie and Pea Supper, two County occasions, also hosting the Alfred Bell Cup and the HVP dinner. The Social Committee members and others were thanked for providing help and food for these occasions.

During the election of Officers, J.D. Cowings became the Club Chairman and with the resignation of Secretary, Mrs M. Cowan, who had held the position since 2006, D.W. Kirk became Club Secretary. Over many years the Financial Statements has been checked by a duly appointed Auditor. In many cases, the person had qualifications in banking or accountancy but now the position of Auditor, and held by A.D. Barritt since 2001, would be re-named Examiner of Accounts. In recent years, the mixed domestic competitions have not been given the support they deserved by members of the Men's Section. In view of this, discussion took place on four of the mixed competitions, viz. Presidents' Triples, Club Pairs, John Nesbit and the recently adopted Emery/Wright competition. Finally, it was agreed unanimously that, in future, the Open Pairs (with luncheon) and the Presidents' Mixed Triples competitions would be held. In connection with forthcoming social events. Mrs M.E.H. Nesbit spoke about the very successful occasion she had organised on behalf of PMH at the local Fratelli Restaurant. With this in mind, it was hoped that the Club would have a similar booking in January. Before the meeting closed Mrs M. Cowan drew to the attention of members that the Club would be 90 years old in 2013 and invited their suggestions to mark the occasion.

The Green Ranger, W.R. Liddle, reported that the greens winter maintenance programme was well in hand with progress displayed on the Clubhouse notice board. It would be appreciated if members would volunteer during the winter to swish the green to restrict the spread of fusarium. External expert advice had been obtained and we are now sourcing materials directly in order to manage green maintenance costs. He

congratulated the Green's Committee on the excellent state of the green surrounds and the two awards received.

In January 2013, a very successful evening was held in the local Fratelli Restaurant which raised £643 towards Club funds. Sadly, Dorothy Emery / Crofts a past President, Secretary, Treasurer, Honorary Life and founder member of the Ladies' Section, who was residing with her family in Hampshire passed away in her centennial year in February 2013. A charity tea was held in the Club on the 12th July, 2013 in aid of the RVI Great North Children's Hospital which raised £505. Lady President, J. Pringle, was indebted to both the hospital consultants and nursing staff who had successfully treated her granddaughter having been diagnosed with leukaemia.

At the 2013 AGM, attended by 45 members, the Club Chairman, J.D. Cowings, commented on the good summer weather and the success on the green enjoyed by both the Ladies' and Men's Sections. The Club was also successful in achieving the Sport England Club Mark Accreditation and awards from 'Northumbria in Bloom' and 'It's Your Neighbourhood' for the bowling green's surrounds. The Club Treasurer, J.T. Harrison, summarised the main points of the Accounts. Both income and expenditure were both down being £22,984 and £16,665 respectively. The



90<sup>th</sup> Anniversary Celebration Cake

surplus of £6,319 was most welcome when compared with the deficit of £2,438 in 2012. The outstanding loan of £4,000 from Bowls England had been repaid and early repayment had earned a £ 600 rebate. Sadly, for health reasons, Alan D. Barritt is no longer able to scrutinise the Accounts and the Treasurer enquired whether someone else would be willing to take on the task. Thanks were extended to Mrs M. Catchpole for her efforts with the Social account. The GPC recommendation that subscriptions for 2014 be unchanged was approved by the members. The Treasurer stated that grants of £1,000 from the County Council Community Chest and also £500 from the Co-Operative Community Fund had enabled the purchase of an aerator for the bowling green. Having held the office of Treasurer for eight years it would definitely be his final year in the position and requested that his successor be found early on to ensure a smooth changeover.

Mrs C. Davison reported on the very successful social events held during the year, particularly that of celebrating the Club's 90<sup>th</sup> anniversary on Presidents' Day. Some members attended in full fancy dress and others wore 1920s headgear. Events in the afternoon were followed by a barbecue.

A lengthy discussion took place on the proposed change to the Constitution to create a new class of Social membership. The Chairman asked members to complete the voting papers already distributed. The proposal was carried, there being 83% of the votes in favour. The related Rule changes were approved by a show of hands. The members agreed with the GPC proposal for a Social membership subscription of £10.

Members were informed by D.W. Kirk that now the Club had received Club Mark Accreditation from Bowls England it was important to retain this status and advised members to acquaint themselves with the Club's Handbook also its policies and procedures. Until junior members are recruited our accreditation is 'core' only and further work needs to be done to obtain full accreditation. Ms S.A. Storey mentioned the facilities at the Club needing to be well maintained and have members who are appropriately qualified in First Aid and the Protection of Children and Vulnerable Adults. Our coaches must be trained and CRB (Criminal Record Basic) checked. It was noted that the recent BDA grant of £290 would have been £600 if we had had Club Mark

accreditation at the time of application.

Following the election of Officers and Committee members, S.A. Storey was appointed the Club's Welfare Officer. The GPC agreed to give further consideration regarding entering a second team in the Public Utilities League to provide more playing opportunities for members.

At the 2014 AGM, attended by 43 members, the Treasurer, J.T. Harrison, stated expenditure had exceeded income by £2,810 due to the purchase of some £10,000 worth of equipment for the green which was offset by grants of £1,500. The Club should now be fully equipped to carry out its maintenance of the green for several years. Although the Bank Balance was in a healthy state at £12,000 additional insurance was necessary to cover the new equipment. A full review of insurance needs to be undertaken of the Club premises. A grant of £290 had again been received from the BDA to assist with development and coaching.

Organised revenue-raising functions continue to make an important contribution with the barbecue (£700) and the January Night Out (£400). Various outside groups who use the Clubhouse during the winter realised £1,500. Thanks were extended to Mrs M. Catchpole for managing the Social Account who with the help of the ladies had raised £809. The members agreed with the GPC's recommendation that all membership fees for 2014 should remain unchanged. Because of personal circumstances, the Treasurer stated that some of his work had been delegated to both Section Secretaries and that an Accounts Scrutineer was still required.

In the Green Ranger's absence, the Secretary, D. W. Kirk, read out his report on green maintenance activities. Thanks were extended to those members for their commitment when helping with the green during the season and for tidying up of the surrounds when the season was closed in September. The Chairman, J.D. Cowings, also thanked W.R Liddle and his helpers for the excellent condition of the green.

Mrs A. Rutter reported on the social activities during the winter months and thanked those concerned with organising and helping with the various successful events. The pre-season dinner was held in the Highlander for the first time which whilst enjoyable the layout of the dining room seating was unsatisfactory. It was decided to revert to Ponteland Golf Club in 2015. Three County matches had been catered for and had gone well and with thanks extended to the helpers on these occasions. The Chairman also extended his thanks to the members of the Social Committee for their efforts on behalf of the Club. He also informed members that the next January event would take the form of a Burns' Night and would be held in Ponteland Golf Club.



Opening Day, April 2015

The Secretary stated that the Taster Sessions would take place next year in May and June as some members complained of the undue time taken up when organised in May. He explained that, at present, our Club Mark is only 'core' and that if the Club wished to obtain full Club Mark accreditation it was necessary to allow children into the Club. We are still the only outdoor bowling club in the northern Counties to have this qualification which will be helpful when making grant-aid applications.

Following the election of Officers and Committee members Ms S.A. Storey was duly appointed the Club's Welfare Officer. A letter from Mrs G. Stapylton was read out by the Secretary thanking members for their support during her term in office as BN Ladies' President.

At the 2015 AGM, attended by 48 members, the Treasurer, J.T. Harrison, outlined the main points of the Balance Sheet. The bank balance was approximately £17,500 with income exceeding expenditure by £4,294 but an invoice for £4,800 had been received with respect to green maintenance. He expressed some concern with subscription income down £629 and the possibility of losing members next season. Income from functions also was down to £1,699 being £550 less than last year. Previously, it was in the region of £3,000 each year. The loss of income from the Arts Group did not help matters. A grant of £290 from BDA in aid of development and coaching had been received. Inevitably, the cost of maintaining the premises was increasing with expenditure on roof maintenance, Clubhouse redecoration and obtaining new tables. Green maintenance costs were less and the Treasurer thanked W.R. Liddle and his helpers for their work on the green. He also thanked Mrs M. Catchpole and other ladies for the management of the Social Account which had raised £593. In closing, J.T. Harrison stated that this would be his last year as Treasurer and a replacement would be required to work alongside him in order to become acquainted with the work involved.

The Secretary, D.W. Kirk, read out a detailed report from W.R. Liddle in which he thanked helpers for the work they had carried out on the green and surrounds throughout the season and since Closing Day. The Chairman, J.D. Cowings, added his thanks to the Green Ranger and his helpers for maintaining the green in excellent condition.

Concerning the Club's social activities, Mrs A. Rutter thanked all the ladies who had worked so hard with the catering arrangements during the season and not forgetting their assistance at the coffee mornings held during the winter programme. The Chairman was thanked for producing tickets for various functions. D.W. Kirk stated that having the Taster Sessions over a longer period and on different days had not proved successful and they should revert to consecutive Saturday mornings as before. The GPC would welcome suggestions on other advertising measures to recruit new members. Friday afternoon sessions with the pupils at Richard Coates School had taken place although an attempt to provide an after school Club had not met with much success. Members were thanked for their support during the sessions both on and off the green.

Before the election of Officers and Committee members, the retiring Chairman, J.D. Cowings, stated it had been a privilege to hold the position and thanked members for their support, particularly the Green Ranger, W.R. Liddle, and the Secretary, D.W. Kirk. The new Chairman, R.J. Varley, referred to the good work of the GPC and the three priorities ahead viz. recruitment of new members, maintain the high standards of the green and to keep the Club at the forefront in the County. Regarding the website, Miss J. Barras agreed to hosting the Club's online activities. Ms S.A. Storey was reappointed as the Club's Welfare Officer. The proposed new Bowls Northumberland Mixed League to take place on Sunday mornings was discussed but it appears there has been little support from the Men's Section. Further to the request by the Public Utilities League for the Club to nominate D.W. Kirk as their next President he was duly installed as League President at their AGM. A Club Handbook is available now for all members to acquaint themselves with its content viz. the Constitution and Rules, structure, job descriptions, members' addresses and telephone numbers, also other items which were considered to be of interest.

At the 2016 AGM, attended by 41 members, J.T. Harrison summarised the main points of the Balance Sheet which showed a deficit of £609. The bank balance was



£16,930. The good news was that the Club had 21 new members but have lost 13. There were some very successful revenue-raising social events, viz. Burns' Night (£600), the barbecue- despite the rain !!!!! (£700) and the Monthly Draw (£560). BDA provided a grant of £300. By far, the largest expenditure is green maintenance but other costs are rising including printing and postage. The GPC is looking into the request by PMH for the Club to make a contribution towards the repairs to their car park. The GPC proposal to increase full membership subscriptions by £5 to £95 was agreed by the members. In closing, J.T. Harrison who became Treasurer in 2008, informed members that this would be his last year in office. Also, for health reasons, A.D. Barritt could no longer serve as Examiner of the Club's Accounts. Later on, F.S. Cowan, agreed to take his place.

W.R Liddle reported on the very successful raising of the bowling green bank-sides alongside PMH and the tennis courts together with the wood batten surrounding the edge of the green that had been straightened. Dampness had caused slow growth at the start of the season with some damage to the green. However, this damage was not as much as bowler's poor deliveries which required the attention of the GPC to address the problem. The Green Ranger will oversee a team/Committee of volunteers next season. Also, he proposed a change in the rota system so that the direction of play is only rotated on a weekly basis.

Mrs A. Rutter reported on the social activities during a busy and successful winter programme. The mid-season barbecue was well attended and hugely successful. Thanks were extended to all those who were responsible for organising the individual events throughout the year. In particular, to those who organised the very successful Burns' Night. Ms S.A. Storey reported on the successful Taster Sessions which had attracted 13 new members.

Following the election of Officers and Committee members, the Chairman, R.J. Varley, announced the GPC had agreed to nominate J.T. Harrison as an Honorary Vice President.. The members present at the meeting approved the recommendation. This recognized his exceptional service to the Club over 25 years as a Committee member, President in 2007, Club Chairman and Treasurer (particularly with the extension of the Clubhouse). In response, he thanked everyone for all their help and support over the years and that it had been an honour and a privilege to serve the Club.

Later on, the GPC expressed their thanks to D.W. Kirk for repainting the internal doors in the Clubhouse during the closed season.

At the 2017 Annual General Meeting, attended by 49 members, the Treasurer, Miss J. Barras, reported a profit of £4,108 for the financial year 2016/2017. The bank balance was £21,037 and social functions continued to be very well supported. Of concern, however, was the decline in Club membership to 138 full members including the recruitment of seven new members at the early season five Taster Sessions. The main unusual expenditure was £1,095 paid to PMH as the Club's share of the cost of repairs to the car park in 2016. There was general discussion regarding an increase in annual fees for full members. It is the intention of PMH to re-surface the car park sometime in the future, and the Club will be expected to pay one-sixth of the estimated total cost £40,000. It was agreed that the annual subscription be raised from £95 to £100 for full members. The annual Accounts were approved by the Examiner, F.S. Cowan.

The Green Ranger, W.R. Liddle, reported that the new system of rotation of the rinks had proved very successful and would be implemented again in 2018. Referring to the raising of the remaining two sides of the green the work had been carried out by a different company, viz. Sports Turf Services. The wood edgings needed replacement and the watering system decommissioned. W.R. Liddle informed the meeting that he was retiring after six years as Green Ranger and that it would be worthwhile increasing the hours of his assistant so that he could take on additional responsibilities. The Chairman, R.J. Varley, thanked the members of the Green Committee for their efforts in

participating in both the “Northumberland In Bloom” and “Britain In Bloom” competitions.

Mrs S. Simmons presented the report on the activities of the Social Committee. It had been a busy year and thanks were extended to all those who had organised the five main winter events. In addition to the outdoor events, the Club hosted the Alfred Bell Cup, the HVPs and BN Ladies' match against Durham. The Chairman, R.J. Varley, thanked all members of the Social Committee and others who had helped making 2017 a most successful year.

Ms S.A. Storey referred to further development of the Club and recruitment. The Taster Sessions sponsored by the BDA were again very successful and necessary in the Club's efforts to increase membership.

At the 2018 AGM, attended by 51 members, the Treasurer, Miss J. Barras, reported a loss of £4,525. This was partly due to a decrease in membership to 121 from 138 last year. but more importantly, an exceptional outlay of £ 6,800 for machinery repairs and the raising of two bank sides. The bank balance was £17,309. Two popular fund-raising activities were the Quiz Evening (£100) and the Beetle Drive (£120) which was sent to the "Crisis at Christmas" charity. The participation in both domestic and league competitions by some of the ten new members provided encouragement for the Club's coaches attending the early season Taster Sessions. Members were informed of the creation of a reserve fund for future maintenance of the PMH car park. Allowing for inflation, the GPC thought it prudent to begin building up a reserve now, of £800 per year. The Examiner, F.S. Cowan, was thanked for auditing the annual Accounts. After some discussion, it was agreed to increase full members' subscriptions by £5 to £105. Associate members would have a £2 increase to £12 but Social members to remain at £10. Associate members are entitled to play on the green on Opening Day, Presidents' Day and Closing Day. The Chairman, R.J. Varley, thanked the Treasurer for her excellent work throughout the year which included management of the Club's website.

It is a pleasure to have seen in Issues 156 and 157 respectively of the Pont News & Views magazine that both Mrs Freda Owen and Mrs Vera Lonsdale celebrated their 100th birthdays' during the summer of 2018. Freda joined the Club in 1975 and was elected Ladies' President in 1981 and again in 1994. Always with a smile she was an active participant on the Ladies' Committees. Also, a keen bowler but played mostly as a fun occasion. She succeeded in winning some of the domestic competitions the results of which are included in Sections 11.2 and 11.3. Freda was still a member when she passed away in 2021, aged 102. Sadly, Vera passed away shortly afterwards. Over the years' Vera was a most respected and very active member of the local community having previously served as a District and Parish Councillor. She joined the Club in the 1980s and featured in Miss Jean Trimble's poem entitled “The Tale Of The Tights”.



Centenarians Freda Owen and Vera Lonsdale

Members were advised to telephone 999 should a medical emergency take place in the PMH car park. You will be provided with the necessary code to unlock the cabinet. No training is required to use the defibrillator as instructions on its use are given in a recorded message.

Club Mark status is a recognition that a Club is well managed and the Club's 5-Year certificate was out of date in 2018. Due to the apparent absence of a Club Mark

assessor in the local area the GPC decided to take down the certificate and alter the Club's letterhead. For the time being, the GPC will carry out its own self-evaluation on a regular basis until a reassessment is made. In connection with the County competitions, the GPC agreed to award £25 each from Club funds to five ladies towards their expenses at the National Finals held at Royal Leamington Spa.

The Green Ranger, W.R. Liddle, expressed his thanks to members who had helped with maintenance of the green throughout the year. In particular, those for their efforts in participating in both the "Northumberland In Bloom" and "Britain In Bloom" competitions. The extremely hot summer caused dry patches when surface water was not absorbed. When the problem was eventually resolved the bowling green returned to running well. The winter work on the green was well in hand including the planned replacement of the wood edging boards. Not being available next season, a work-schedule has been produced by W.R. Liddle for future maintenance of the green by a Committee of volunteers. He will, however, continue to monitor and purchase materials. The Chairman, R.J. Varley, expressed thanks on behalf of the Club for his work in managing the problems that had arisen this year and for his efforts throughout his six-year tenure as Green Ranger.



Medical Emergency Aid at PMH

On behalf of the Social Committee, Miss S. Barras reported on both a busy and successful season which included new events in the winter programme. The Club hosted one Ladies' and two Men's County matches. The Chairman, R.J. Varley, thanked her and all of the Social Committee for their excellent work throughout the year.

In 2019, the GPC began looking at the future direction of the Club following a fall in the Club's membership of 20% during the past 15 years. It will focus its efforts on communication with members and others outside the Club. The Chairman, P. Kilmister, is actively building up a profile on Facebook to run alongside the website in an attempt to attract a wider audience for the Club. Copies of a new booklet "Guidance for New Bowlers" issued by Bowls England to be made freely available to new members.

The Burns' Night event and the annual pre-season dinner were held in Ponteland Golf Club. Thanks were extended to everyone who supported the fundraising event held in the Clubhouse in May 2019 which raised over £550 for the Motor Neurone Disease Association.

Unfortunately, the 2019 bowling season fixtures were affected by changeable wet weather conditions and the joint Presidents' Day event was cancelled on two occasions. During the past few years the combined membership level of the Club has been around 160 (including Associate and Social members). The excellent efforts of the Social Committee together with help from other members have contributed greatly in retaining members' subscriptions at an acceptable level. In addition, donations, grant aid other revenue-raising events have helped to a great extent towards the running costs of the Clubhouse, also the significant expenditure on green maintenance, new machinery and its maintenance.

At the 2019 AGM, attended by 52 members, the Treasurer, Miss J. Barras, reported a profit of £1,183 due to an increase in membership which had not been seen

in recent years. The bank balance was £18,732. In order to keep subscriptions at a reasonable level she drew attention to the need to recruit new members, bearing in mind the increasing costs of maintaining the green and its equipment, also the Clubhouse. There followed considerable discussion on the introduction of green fees and increasing subscriptions to avoid relying on income from its functions. A successful vote was taken on the proposal by Mrs E. Cowings for a £5 increase in the full membership fee in 2020 to £110, the other fees being unchanged. The Chairman, P. Kilmister, thanked both the Treasurer and the Examiner, Sid Cowan, for the financial report.

In connection with the bowling green the Green Ranger, W.R. Liddle, thanked both Mesdames J. Barras and S. Barras for their excellent work on the green surrounds. Heavy rains during the season had caused problems but were manageable. He reported the winter programme was underway and the presence of some disease in the green was being monitored. Hopefully, an organic regime is being used which will overcome the problem as the older treatments are no longer available. Costs are rising significantly, grass seed having recently increased by 20% and further large increases expected next year. He said the recently purchased verti-cutter would assist aeration and should improve drainage together with hollow tining of the green. Thanks were extended to other helpers during the season and it was confirmed that the rota for swishing and brushing of the green each day would continue throughout the winter. The Chairman thanked him and his helpers for maintaining the bowling green in such an excellent condition.

Concerning Social Committee activities, Mrs O. Driver reported the Winter Programme was in place. It was proposed that Mesdames R. Twizell and A. Rutter would share chairing of the Committee. It was also proposed that during the coming year each event would be the responsibility of a different member in order to even out the workload. On behalf of the GPC, the Chairman thanked the Social Committee for their work during the year. The Secretary, D. Kirk, informed the meeting that the GPC were very conscious of the need to recruit, retain and develop members. For this purpose, a working group had been set up to provide ideas and report back to the GPC by February 2020.

Following the election of Officers and Committee members, P. Kilmister, the Chairman and a member of the PMH Committee reminded members that the building was almost 100 years old and renovation of both the site and building was necessary. In particular, any work on the car park would inevitably affect the Club and he would inform members of any developments. In addition, the GPC nominated a small group which will be responsible for looking at any proposals regarding the use of the car park. P. Kilmister mentioned the Winter Social Programme and expressed the need for support from members. He then spoke about the work carried out by members and particularly those who had given a great deal of service to the Club. In recognition of the work carried out over many years by Mrs E. French he proposed that she be made an Honorary Vice President. This proposal was seconded by the Ladies' President, Olive Driver, and was agreed by the members present. On closing the meeting, the Chairman thanked the members of the GPC and all the volunteers who had helped the Club throughout the year.

Sad to relate past member John S. Duff, aged 102, passed away in August 2019. He joined the Club in 1978 and was elected President in 1984. John was an excellent bowler and keen to help novice members to improve their game. Although a forthright member on various Committees he was also a valued member of the Pavilion extension Working Party in 1982, and referenced in Section 8. At their home, John and his late wife, Marjorie, hosted several very successful revenue



Centenarian John S. Duff

- raising events in the 1980s. In his most recent years, registered blind, he occasionally visited the Club whilst on his daily walks and readily conversed with friends on times past.

In January 2020, the Burns' Night Evening held in Ponteland Golf Club was again very successful and also the other various winter social events. It was decided at a GPC meeting to apply half-membership fees in order to ensure the Club emerged from the Covid-19 situation in a sound financial position. There had been a significant drop in Full membership from 114 down to 89. Regardless of considerations leading to reduced fund-raising events, there was only a deficit of £20 on the Club's financial year.

Following the recent introduction of car parking charges at the PMH it was no longer necessary for the Club to set aside an annual payment of £800 to help cover car park repairs. The combined efforts of GPC members in preparing the programme of fixtures for 2020, its social events and members' general meetings were to no avail due to the outbreak of an extremely contagious Covid-19 virus. Following guidance from the Government, medical authorities and Bowls England, a special GPC meeting was held in March 2020 and a decision taken to close all activities at the Clubhouse immediately. Members, however, could still visit the Clubhouse but needed to follow the strict social distancing rules incorporated in the Government's guidelines. Regular GPC meetings were held albeit some were communicated via e-mail. Members would be notified of any decisions taken by the GPC via the informative Newsletters posted on the PBC website and placed in the Clubhouse.

Being mindful of social distancing requirements and limited access to attendance at the green, approximately half of the members played bowls in 2020. Regrettably, plans to celebrate VE Day, on the 8th May, 2020 were cancelled.

Early in 2021, the Club Treasurer, Miss J. Barras, confirmed that expenditure far exceeded any income received due to closure of the green. During this time, the Club Secretary, D.W. Kirk, had tendered his resignation and the GPC expressed their gratitude for all his efforts on behalf of the Club. A relatively new member, D. Burbeck, assuredly with enthusiasm for the tasks in hand, agreed to take on the role of Club Secretary.

The GPC reluctantly decided to cancel all league and friendly fixtures in 2021 to ensure safety compliance of members at the Club. The domestic competitions could take place and with ending of lockdown restrictions in mid-summer it allowed full use of facilities at the Club. During August, two social events viz. "Bring Your Own" Picnics were arranged which provided an opportunity for members to bring along their friends and to meet other members outside on the patio area.



VE Day, 8th May, 2020

The Presentations of Ladies' and Men's Trophies took place on Closing Day. During the winter months, social events were organised including Coffee Mornings and a festive gathering for Dotty Dominoes with mulled wine, mince pies and sausage rolls.

At the 2021 AGM, attended by 53 members, the financial reports covering the period 2019 to 2021 were presented by Miss J. Barras. Due to the virus there was less

income and expenditure. The continuing loss in membership was a concern and a recruitment campaign was needed. Following much discussion the members agreed to increase the annual subscription to £140 in 2022. The introduction of car parking charges at PMH had not helped. The Chairman, D. Redpath thanked both the Treasurer and the Examiner, F.S. Cowan, for their efforts on behalf of the Club.

The Green Committee, in the absence of a green-keeper, was led by P. Kilmister and all were thanked for their work in maintaining the bowling green in excellent condition in difficult circumstances. The maintenance schedule introduced by former Green Ranger W.R. Little over the years had been most helpful and he was duly thanked for all the work he had carried out for the Club. During the election of Officers W. Howard was appointed Green Ranger. He drew attention to the substantial damage to the green caused by birds and would appreciate any ideas to minimise the problem. The Green Committee would include 14 volunteers. The programme of social activities was being considered by Mrs V. Telfer and seeking new members for its Committee.

At the Election of Officers and Committee members there were two candidates for the role of Club Chairman. Following a secret ballot R.D. Redhead was declared the winner having received 32 votes to the 21 received by Ms S.A. Storey. Following the elections, the members agreed with P. Kilmister's suggestion of arranging mixed Saturday and Tuesday morning rollups as part of the Club's programme of events. Also, they agreed with his suggestion for a new mixed competition to honour both Percy and Lorna Telfer for their long-term support of mixed competitions. The GPC decided they did not need qualified coaches at present mainly because of the cost involved having to pay for the qualification and then annually to remain an active coach. It was considered the Club has several members who are able to help others improve their skills. Newly appointed Club Secretary, D. Burbeck, raised his concerns regarding the future of the Club. He expressed the need to promote the Club in order to encourage the local community to engage in both its bowling and social events. In particular, to take on responsible positions on the Club's Committees. For this purpose, he had prepared a detailed document outlining his thoughts regarding the Club's future.

Mrs M. Turner informed the meeting that Ms S.A. Storey would be the Lady President of Bowls Northumberland in 2022. Following applause by the members the customary hosting of a match for the incoming President's Club was agreed.

In January 2022, a local Art Group resumed use of the Clubhouse for an 8-week period. Also, work was in hand developing a new website and built in the background of the present one. It will have a corporate/brand image to be seen on everything in which the Club will be involved. Members of the GPC and Section Committees are seeking support from members to undertake promotional activities and help with recruitment. The pre-season dinner was held in Ponteland Golf Club and again proved to be an enjoyable evening. Other social gatherings included Coffee Mornings, a Quiz Night prior to Opening Day and the Summer Barbecue. New competitions were being arranged. Of particular interest is the Blue Series event to be played over a two-month period, involving a restricted jack length. Hopefully, this would encourage both novice bowlers and newcomers in the Club to participate in competitive events.

It is pleasing to record the efforts of the GPC and other members on publicizing the Club which has resulted in an exceptional intake of more than 40 newcomers in 2022. The use of media Facebook to promote the Club in the local community has been undertaken. Regular early season Taster Sessions have proved to be successful in encouraging younger persons new to bowls to join the Club and enjoy the organised social events. A new Member, Ian Cahill, undertook a charity ramble of 430 miles in Scotland and raised more than £2,350 for the British Heart Foundation, Alzheimer's Society and the Royal Air Force Benevolent Fund.

A recently retired playing member, John M. Gill, celebrated his 100th birthday in March 2022. He has been at the Club for more than twenty years. A biography of his professional career and achievements worldwide may be seen in Issue 198 of Pont News & Views. This narrative now records the names of five members of the Club who have celebrated their 100th birthday.



Centenarian John M. Gill

A Joint Presidents' Day event was held in bright albeit breezy conditions. The match between the ladies and the men was very well contested with the men winning by a small margin, 19 shots to 17. Another event on the social calendar in August 2022 proved to be a very enjoyable afternoon of bowling which was followed by Pie & Peas and a drink in the Clubhouse or outside on the patio area.

In July 2022 the Club members had a surprise visit from Guy Opperman the local Conservative MP accompanied by Rishi Sunak who later in October 2022 became the Conservative Leader and UK Prime Minister.

The annual Brian & Kathleen Armstrong Memorial Trophy competition, first held in 2002, was resumed following the Covid-19 virus, and was won by the Men's Section. An enjoyable end-of-season dinner along with the annual presentation of trophies was held in Ponteland Golf Club.

At the 2022 AGM no details were available of attendance. Following the Financial Report by the Treasurer, Miss J. Barras, it was decided the annual subscriptions remain unchanged at £140 in 2023.

The Chairman, R.D Redhead, stated that to maintain fees at acceptable levels it was incumbent on members to help freely around the Clubhouse and bowling green. The Green Ranger, W. Howard presented his Report and he thanked those members and, in particular, A. Barratt, who had given up much of their time in keeping the green in such an excellent condition. Some of the maintenance problems are referred to in Section 7 of this narrative. The Social Committee Report was presented by Mrs V. Telfer. Reference was made to the very successful revenue-raising events held throughout the year following the two-year period of Covid-19. After expenses, £2,362 was raised from several functions which had helped greatly to ease financial pressures on the Club. The ladies' regular coffee mornings raised £515. On closing, she expressed her heartfelt thanks to the Committee members for their efforts at the various functions. Following the resignation of Miss J. Barras as Club Treasurer, the position was taken on by Miss A. Shipley. A number of items came up for discussion including Data protection, Club Centenary Year, GPC Issues, Dress Code, New domestic competitions and Social media Facebook.



A change from politics for Rishi Sunak

As part of the widening of social opportunities the Club can offer its members, a Christmas dinner was organised and followed by a Dance-type Disco which was very

well attended. Interestingly, similar events were arranged in the pre-war years from 1935 and onwards to the 1950s and are referred to in Section 1.1. The winter programme of Coffee Mornings began in October but were held over during the Christmas period of refurbishment in the Clubhouse. The usual social calendar of events viz. pre-season coffee mornings, Quiz Nights and an Afternoon Tea were resumed shortly afterwards.

A recent Club Personal Data Protection Policy has been introduced which is National legislation and applies to all our members. A form needs to be completed permitting the Club to use their name, e-mail address and telephone number in both its administrative affairs and communications.

The role of Welfare Officer at the Club and previously held by Ms S.A. Storey no longer exists due to the conditions laid down in the documents issued by Bowls England to ensure all bowling clubs viz. "Safeguard Children and Vulnerable Adults". Ms Julie Tough has temporarily accepted the position of Safeguarding Officer as her main role before leaving the police service was Safeguarding and also advised the Government on policy, practice and guidance.



Joint Presidents' Day, July 2022

In April 2023, a well attended and excellent annual pre-season dinner was held in Ponteland Golf Club. The Taster Sessions throughout May have helped greatly in the recruitment of members. At a recent event, the BE Junior Vice President, Mrs Sheila Storey, was present and most impressed with its organisation. She would be reporting back to BE on the Club's successful recruitment campaign.

In July 2023, Mrs Carolyn Burbeck and Bernard Wright commemorated the centenary year of the Club with a visual display of artefacts in the Clubhouse. The items included lignum vitae woods, composition bowls, carpet bowls, domestic competition trophies, photographs illustrating the Club's history from 1923- 2023. and other related information. Also, in July 2023, on a rather somewhat breezy and sunny afternoon, PBC entertained the Bowls England President's Touring team which resulted in a thrilling win for the hosts by 11 shots. The result, 100- 89, was an excellent score-line - it featuring the Club's 100 shots in the Centennial Anniversary match. It is pleasing to record some members of Bowls England President's Team remarked on the friendly atmosphere within the Club and of its attractive surrounds.

Disappointing weather in 2023 impacted on the popular outdoor fund-raising activities to the extent only £1, 341 was obtained from functions. Reflecting on the 2023



season, the Joint President's Day event was postponed in July, also in August and then ultimately cancelled in September. In addition to the Taster Sessions, an afternoon Jumbles and Pie and Peas event was held in May. Another successful Jumbles with Barbecue was held in July. The income from regular coffee mornings was down 64% from 2022 at £185. Throughout the 8-year period, 2016- 2023, the average receipts from functions was £3,935 p.a. contributing 20% towards total expenditure. Over the same period, the Club was pleased to receive an average of £937 p.a. in donations.



**PBC Centenary Year Commemorative Display, 12th July, 2023**



**PBC and BE President's Touring Team, 12th July, 2023**

**(l-r) : D. Burbeck, Miss A. Shipley, R.D. Redhead, Mrs P. Varley, A.O. Christie, Mesdames J. Nixon and A. Pearson, M. Anderson, Mrs L. Marsh, R. Pearson, Mrs E. Emmerson, C. Potts, C. Ling, S. Edwards, Mesdames E.J. Ramsay and V. Telfer, G. Lord, Mesdames M. Cowan and M. Turner, D. Smith, Mrs J. Galbraith, J.T. Turner, Mrs I. Eden and W. Howard**

**(l-r) : Mrs Sheila Storey (JVP), President Deepak Tanna and David King-Taylor (SVP)**



**PBC Centennial Anniversary Match against BE President's Touists, 12th July, 2023**

Interestingly, two members of the bowling Club viz. Gloria Stapylton and Julie Tongue were joined by soccer fans at Ponteland Leisure Centre on the 20th August to watch Lucy Bronze playing for England against Spain in the 2023 Women's World Cup Final in Sydney, Australia. The 1- 0 defeat by Spain was a great disappointment to the grandmother and aunt respectively of Lucy, but they were proud of how well she had performed throughout the entire tournament. Lucy has represented the senior England team on more than 110 occasions.



**Grandmother Gloria and Aunt Julie watching Lucy Bronze playing in the 2023 Women's World Cup Final in Sydney, Australia.**



**Flags on display**

*Courtesy of BBC North East and Cumbria*

It has been a pleasure to record the bowling achievements of past and present members in Sections 3, 6 and 11. In 2023, the most notable performance was achieved by Mrs Ann Pearson who joined the Club six years ago. On winning no fewer than five domestic and a joint County title in one season is an outstanding performance. Previously selected to represent the County in 2021. Also, in the 2023 Brian & Kathleen Armstrong Memorial Trophy Ladies v. Men event, the Singles match between the men's champion, Bill Howard, was won by the ladies' champion, Ann Pearson.



Maria and Ann with three Singles trophies

Also attending the Centenary celebrations was a very well-known former member, Mrs Maria Shuttleworth, whose outstanding bowling achievements are recorded in Sections 3, 5 and 11 of this narrative. In 1993, Maria won the three Ladies' Singles competitions, viz the 2-, 3- and 4-Bowl titles. The achievement was emulated thirty years later by Ann Pearson in 2023.

The end-of-season dinner was held in Ponteland Golf Club. The final game of the season was followed by a Faith Tea in the Clubhouse and annual presentation of trophies.

## 1.4 Financial Review of Social Activities

Looking back when the Club was formed in 1923, the members paid green fees until the introduction of annual subscriptions in 1951. Together, with the proceeds from occasional social gatherings organised by the ladies, it usually provided sufficient income for normal outgoings. PMH were responsible for green maintenance costs until 1970.

From an examination of Treasurer's reports, the proceeds from coffee mornings in the 1970s averaged approximately £80 p.a., contributing 16% towards the total expenditure. As in other years, other income was obtained mainly from annual subscriptions and donations.

In the 1980s, the proceeds from coffee mornings and other social functions averaged approximately £200 p.a., contributing 7% towards total expenditure.

In the 1990s, following improvements to the Pavilion, the proceeds from coffee mornings and an increasing number of social functions averaged approximately £700 p.a., contributing 9% towards total expenditure.

In the 2000s, following the erection and later the extension of the Clubhouse, the proceeds from regular coffee mornings and excellent social functions have averaged approximately £5,200 p.a., contributing 28% towards total expenditure.

In the 2010s, the proceeds from excellently supported social functions have averaged approximately £5,880 p.a., contributing 27% towards total expenditure.

## 1.5 Honorary Membership

### 1.5.1 Men's Section

Normally awarded to members at Annual or Spring meetings, in recognition of services to the Club. However, in the case of R.F. Pascoe, the GPC Chairman, J. Oliver, proposed his election at a meeting held in May 1974, which met with the agreement of the members present. His name, however, was not put forward for approval at the subsequent AGM but would have been accepted by members. The year of an award, in chronological order, is shown in parenthesis.

- **Life Members (15)**

- C.F. Jameson (1970). Founder member. Died 1977.
- R.F. Pascoe (1974). Left the Club in 1979.
- R. Selby (1975). Died 1981.
- W. Mole (1976). Died 1985.
- M. Johnstone (1976). Died 1979.
- R.S. Wilkinson (1977). Moved to Teesside in 1977. Died 1978.
- J.A. Main (1979). Retired to Devon in 1979. Died 2005.
- W. Middlemiss (1981). Died 1989.
- J. Carr (1983). Died 1993.
- E. Forster (1983). Died 1986.
- W. Wilson (1984). Died 1988.
- T.W. Cuthbert (1986). Died 2002.
- T. McPhee (1986). Died 1998.
- B.D.W. Wright (1988).
- J. English (1994). Died 2008.

- **Vice Presidents (6)**

- \* \* W. Barrons (1941). Founder member. Died 1951.
- E. Scholes (1997). Died 2016.
- A.M. Maclean (1999). Moved to the Midlands in 2001. Died 2011.
- R.B. Baxter (2001). Died 2009.
- R. Stafford (2008). Died 2017.
- J.T. Harrison (2017).

\* \* In the early years, in addition to a Chairman, Vice Chairman, President and Vice President, several Vice Presidents were elected at the AGM. W. Barrons was made a life Vice President in recognition of his long service with the Club.

### 1.5.2 Ladies' Section

- **Life Members (10)**

- L.H. Loughton (1971). Died 1982.
- J. Mole (1972). Died 1988.
- F.M. Bird (1983). Died 1983.
- E. Mills (1983). Died 1989.
- E.M. Roper (1983). Moved to North Yorkshire in 1983. Died 2003.
- M. Cassie (1994). Died 2019.
- G. Cattliff (1994). Died 2005.
- D. Crofts (1994). Moved to Hampshire in 2004. Died 2013.
- L. Stockman (1994). Died 1996.
- E. Younger (1994). Died 2003.

- **Vice Presidents (2)**

- M.E.H. Nesbit (2012). Died 2023.
- E. French (2019).

## **1.6 Fund-raising Summary, 1935 - 2022**

From the Club's records, it may be seen that members have participated in many activities to raise funds for the Club and deserving charities - both locally and nationally. The principal functions which have taken place include Jumble Sales, Bridge Nights, Domino Drives, Whist Drives, Buffet Dances, Christmas Eve Dances, Old -Tyme Dances, Annual Garden Parties, Barbecues, both Chinese & Italian Evenings, Coffee Mornings, Curry Evenings with Quiz, Fish & Chip Suppers, Hot Pie & Peas Suppers, Quiz Nights and more recently Dotty Dominoes.

The beneficiaries from some of the above social events are as follows :

1935 Ponteland Memorial Hall  
1936 Ponteland Memorial Hall  
1943 Mrs Churchill's "Aid to Russia" Fund  
1945 Ponteland Memorial Hall  
1946 Royal Victoria Infirmary, Ponteland Memorial Hall  
1947 Ponteland Memorial Hall  
1948 Dunston Hill Emergency Hospital  
1953 Ponteland Flood Relief Fund  
1955 Ponteland Memorial Hall Extension Fund  
1968 NCBA Benevolent Fund  
1982 Guide Dogs for the Blind  
1985 North - East Cancer Campaign  
1986 Cancer Relief Fund, League of Friends of Hunter's Moor Hospital, EBA Building Fund and Northumberland Playing Fields Association  
1987 PADAC Local Charity, Ponteland Hospital League of Friends and a participant in the Paralympic Games in Korea  
1988 Ponteland Hospital  
1989 Cancer Research UK  
1990 Cancer Research UK and Crossroads - a charity caring for Carers  
1996 English National Association of Visually Handicapped Bowlers  
2002 NSPCC Charity  
2004 Blind Bowling Association  
2006 English National Association of Visually Handicapped Bowlers and NCBA Charitable Trust  
2008 Blind Bowling Association  
2009 Asthma Relief Bowls Event  
2012 World Blind Bowls participant  
2013 RVI Great North Children's Hospital  
2014 Great North Air Ambulance  
2017 Great North Air Ambulance (HVPs fixture)  
2018 Macmillan Nurses, Crisis at Christmas  
2019 Motor Neurone Disease Association  
2022 Alzheimer's Newcastle UK, British Heart Foundation and Royal Air Force Benevolent Fund

## 2

### PBC Fixtures & Results

#### 2.1 Men's Section

In the early years, the Club participated in the Northumberland & Durham B.A. (N&DBA) league competitions. Twelve regional preliminary round fixtures for the Cowen Cup were played on Wednesday evenings. Ten fixtures were played on Tuesday evenings for the John Sinclair Cup. The results in 1935 were disappointing and the Secretary thought ' *better results would be obtained if players would practice more* '. Wise words indeed. In 1936, the Club entered a team in the Chronicle Cup competition the proceeds from which were donated to the Royal Victoria Infirmary. The Club's results in the 1936 league competitions were the best ever achieved, and were better still in 1937.

In 1936, the Club played Morpeth in a friendly match which was re-arranged to be played in Ponteland ' *in order to augment takings.* ' Casual green-fees were given to the PMH towards its redemption of debt. In 1943, the Ponteland Civil Defence Bowling League was born as a result of the Club rink competitions arranged in aid of the ' Wings for Victory ' Savings Week. A major benefit was the increase in Club membership from these activities. With food rationing, it was difficult to arrange faith teas for the friendly fixtures. Consequently, in 1946, some visiting teams brought their own snacks with the Club providing liquid refreshment, with the help of the ladies. On these occasions, the Club members paid for the visitors' green-fees.

During this time, there was much discussion as to whether the Club should consider withdrawing from the N&DBA in favour of the Northumberland County B.A. (NCBA). The NCBA was founded in 1922, and was affiliated to the English Bowling Association (EBA), which was itself founded in 1903. Highlights of post-war fixtures held in Ponteland (PBC) are listed below.



PBC League Match Scorer, circa 1946



**NCBA Edwardson Cup Winners, 1947**

**Standing (l - r) : R. Meek, J. Neal, J.M. Moorhead, W.L. Hepple, A. Walker, C.F. Jameson, R. Yates, J. Oliver, T. Fatkin, E. Morley and E. Forster**

**Seated (l - r) : W.V. Reed, K.B. Straughan, R.F. Pascoe, E. Stokoe (Secretary), W. Barrons (Chairman), J. Carr, J.H. Hall, H.B. Stobert and J. Robson**

**Front (l - r) : M. Johnstone and W. Urwin**

In 1947, PBC won the Edwardson Cup for the first time by defeating Brighton B.C. in the Final by 39 shots, 92 - 53.

In 1948, PBC were runners-up in the Clegg Cup competition.

In 1949, PBC were Divisional winners in the Clegg Cup competition.

In 1952, PBC entertained the NCBA League Team.

In 1954, PBC hosted one section of the Northumberland Challenge Cup competition. In 1955, PBC entertained visitors from Welham B.C., Yorkshire and the Surrey Tourists.

In 1956, PBC entertained the NCBA League team. In the Clegg Cup competition, PBC was the runner-up to Walker Park B.C. and were Divisional winners in 1957.

In 1963, PBC again won the Edwardson Cup, by defeating Whitley & Monkseaton B.C. in the final held at Willington Quay B.C.

In 1964, as holders of the Edwardson Cup, PBC entertained the Rest of the NCBA League side. Also, in 1964, the Northumberland Challenge Cup was won by PBC for the first time. With the recent successes in the County competitions, the Club was invited by Portland Bowling Green Club to participate in the Alfred Bell Cup competition held annually between the north-eastern private clubs.

In June 1965, PBC hosted one section of the Alfred Bell Cup competition.

In 1966, PBC was successful in winning the Edwardson Cup for the third time. It was considered a most creditable achievement because of the relatively small membership. Tom McPhee's rink had an excellent 40 - 3 score-line in the overall result

85 - 58. The first friendly and competitive Sunday matches were played during the 1966 season.

In 1967, as holders of the Edwardson Cup, PBC entertained the Rest of the NCBA League side.

In 1968, PBC hosted the private clubs' J.M. Oubridge Cup competition. In September 1968, the first PBC Ladies v. Gents match was arranged. This became an annual fixture in 1980.

In 1970, PBC hosted one section of both the Northumberland Challenge Cup and the Alfred Bell Cup competitions.

In 1973, PBC won the first North-East of England Private Clubs League (NEEPCL) the matches being played on a Sunday. This was the first league competition to be played in white dress. Also, in 1973, PBC was the runner-up against Summerhill for the Alfred Bell Cup.

In 1974, PBC hosted one section of the Alfred Bell Cup competition.

In 1975, PBC hosted one section of the Northumberland Challenge Cup competition.

In 1977, the inaugural NEEPCL Gala Day Trophy competition, held in Summerhill, was won by PBC with Hexham the runner-up.

During the 1970s, PBC had produced some poor results and, in 1979, won only one of their fourteen friendly fixtures. The highlight of the season was the invitation match arranged with the Mayor of CMBC, Cllr D. Adams, and County Officers, which was followed by an excellent buffet supper in the PMH. Matches with the Mayor's team became a regular fixture.

In 1980, on the wettest June day ever recorded, PBC hosted one section of the Alfred Bell Cup competition. Only the excellent catering arrangements, which included hot soup, made the day worthwhile for the competitors. The season ended with a Ladies v. Gents match which was followed by a faith tea. This has proved to be a popular annual fixture at the Club.

The planned opening of the bowling green on the 25th April 1981, was delayed one week due to a heavy snow-fall. In 1981, PBC hosted one section of the Northumberland Challenge Cup competition and, in July, provided three rinks for a private Newcastle Chronicle & Journal match.

In 1983, PBC entertained the Perth B.C. tourists from Scotland and hosted the Lewis Wilson Cup competition.

In 1984, PBC hosted the private clubs' J.M. Oubridge Cup competition and entertained a Northumbria Police team. Matches with the local Police team became a regular fixture.

In 1985, PBC hosted one section of the Alfred Bell Cup competition.

In 1986, PBC entertained teams from both the West Midlands and the Bedfordshire Police Forces.

In 1987, PBC won the Clegg Cup for the first time. PBC entertained tourists from Kislingbury, London Parks, Malvern and West Edinburgh.





**PBC Team in the Northumberland Challenge Cup Competition  
played at Ponteland, 26th July, 1975**

**(l - r) : A. Young, J.A. Main, T.W. Cuthbert, F.L. Kitto,  
B.D.W. Wright, J. English, J. Oliver and T.R. Burn**

In 1988, PBC hosted another match with the London Parks B.A. tourists. PBC were runners-up to Gosforth in the Edwardson Cup Final.

In 1989, PBC entertained tourists from both Retford Town Bowling Green Ltd (Notts) and Shefford B.C. (Beds).

In 1991, PBC hosted one section of the Northumberland Challenge Cup competition. PBC also entertained the Norfolk Police which was followed by refreshments at the Northumbria Police Headquarters. PBC won for the first time, the Lewis Wilson Trophy competition.

In 1992, PBC again won the NEEPCL Gala Day trophy.

In 1993, PBC entertained tourists from both Wigton B.C. (Cumbria) and Dunnington B.C. (Yorks).

In 1994, PBC hosted the private clubs' J.M. Oubridge Cup competition.

In 1995, PBC hosted the Lewis Wilson Trophy competition, also one section of the Alfred Bell Cup competition. Ponteland progressed to the final, played at Portland Bowling Green Club, only to lose to Hexham B.C.

In 1996, PBC hosted one section of the Northumberland Challenge Cup competition and an invitation match with the NCBA HVPs.

In 1997, PBC hosted the Edwardson Cup Final, won by St George's Hospital, and an invitation match with the NCBA HVPs.

In 1998, PBC hosted the Edwardson Cup Final, won by Collingwood. In addition, PBC hosted an invitation match with the NCBA HVP's, a County 2-Bowl Singles competition, the NEEPCL Men's Gala Day competition, and the Gosforth Tourists B.C. In the Knight Cup competition, Ponteland "A" were promoted to Division 2.



**NCBA Clegg Cup Winners, 1987**

**Standing (l - r) : A. Wilkinson, T. McPhee, M.A. Bennett, J. English and J. Graham.  
 Seated (l - r) : S. Wright, M. Wearmouth, T.W. Cuthbert, S. Rutherford and  
 R.I. Shuttleworth  
 Front (l - r) : J.W. Nesbit (non-playing President) and T. Lumley**

**Absent : W. Ridley and R. Stafford**



**Lewis Wilson Trophy Winners, 1991**

**(l - r) : R. Stafford, D. Boland, R.I. Shuttleworth, T. Lumley, G. Bowmer and P. Telfer**

In 1998, PBC hosted the Edwardson Cup Final, won by Collingwood. In addition, PBC hosted an invitation match with the NCBA HVPs, a County 2-Bowl Singles competition, the NEEPCL Men's Gala Day competition, and the Gosforth Tourists B.C. In the Knight Cup competition, Ponteland "A" were promoted to Division 2.

In 1999, PBC entertained tourists from Potterton Int. B.C., Warwicks and hosted the Edwardson Cup Final, won by Gosforth.

In 2000, PBC hosted the Edwardson Cup Final, again won by Gosforth, and entered both the Parliamentary and Nines Leagues.

In 2001, PBC hosted the Alfred Bell Cup, the Northumberland Challenge Cup, and the Edwardson Cup Final won by Gosforth for the third year running. As winners of the NCBA Nines League Division 3 competition PBC were promoted to Division 2.

In 2002, PBC hosted the Edwardson Cup Final, won by St George's Hospital. PBC was the runner-up in the NCBA Nines League and promoted to Division 1. The first pre-season trial match was played between the PBC Clegg Cup and Knight Cup teams.

In 2003, PBC hosted the Edwardson Cup Final, again won by St George's Hospital. PBC finished second in an invitation two Mixed-Rinks competition, which was played at Spittal, to commemorate the Union of the Crowns in 1603.

In 2004, PBC hosted the Edwardson Cup Final, won by Gosforth, and an invitation match with the NCBA HVPs.

In 2005, PBC hosted the Edwardson Cup Final, won by St George's Hospital, and an invitation match with the NCBA HVPs. The Clegg Cup and Knight Cup teams were promoted to Divisions 2 and 3 respectively. In the NCBA Nines League, however, the Club was demoted to Division 2. PBC entered the NCBA Jubilee Cup competition.

In 2006, PBC hosted the Edwardson Cup Final, won by Backworth Welfare, the J.M. Oubridge Cup Final, the Jubilee Cup Final and the visiting NCBA Presidential Select team led by D.W. Kirk (Northern Electric). Subsequently, the President joined PBC having previously taken over as the NCBA League Secretary after the resignation of R.I. Shuttleworth in November 2004.

In 2007, PBC hosted the Alfred Bell Cup (Preliminary Round) and the Edwardson Cup Final, won by Gosforth. In the League competitions, the Nines, Clegg Cup and Knight teams were promoted to Divisions 1, 2 and 2 respectively.

In 2008, PBC hosted the Edwardson Cup Final, won by Backworth Welfare. Overall, the League results for PBC were varied and both the Nines and Knight Cup teams were demoted to Divisions 2 and 3 respectively.

In 2009, PBC entertained the Bowls England President's Touring team which resulted in a convincing win for the visitors by 67 shots, 166 - 99. PBC hosted the Edwardson Cup Final, again won by Backworth Welfare. The Clegg Cup and Nines teams were both promoted to Divisions 1 but the Knight Cup team was relegated to Division 4. PBC won its section in the Northumberland Challenge Cup competition and was within two shots of reaching the final of the Alfred Bell Cup competition.

In 2010, PBC won the Jubilee Cup Final defeating High Heaton. A single shot prevented PBC from a place in the final of the Northumberland Challenge Cup competition. PBC hosted the Edwardson Cup Final, won by Backworth Welfare for the third year running.



**NCBA Nines League Division 3 Winners, 2001**

**Standing (l - r) : W.R. Liddle, R.I. Shuttleworth, G.D. Bennett,  
R.A. Peckham, P. Telfer, H. Robson and R.J. Varley  
Seated (l - r) : F. Knight, J.T. Harrison and R. Stafford**

**In 2011, PBC hosted the Edwardson Cup Final, won by Gosforth. A single shot prevented PBC from a place in the final of the Alfred Bell Cup. PBC were runners-up to Backworth Welfare in the Northumberland Challenge Cup. PBC, in its first year of participation in the Public Utilities League, won the Division 3 title with a record number of shots and were promoted to Division 2. The Clegg Cup team were relegated to Division 2 but the Parliamentary League team had by far its most successful season.**

**In 2012, PBC hosted the Edwardson Cup Final, again won by Gosforth, and an Alfred Bell Cup Semi-final. In the Public Utilities League PBC were promoted to Division 1.**

**In 2013, PBC hosted the Edwardson Cup Final, won by Backworth Welfare.**

**In 2014, PBC hosted the Edwardson Cup Final, won by Gosforth. Ponteland "B" team won the Jubilee Cup Final against Benfield and the Clegg Cup team were promoted to Divisions 1.**

**In 2015, PBC hosted the Edwardson Cup Final, again won by Gosforth. The Clegg Cup team's promotion to Division 1 was short-lived being relegated to Division 2.**

**In 2016, PBC hosted the Edwardson Cup Final, won by Backworth Welfare, and a semi-final of the Debmatt Challenge Cup. PBC won the Nines Division 2 title.**

**In 2017, PBC hosted one section of the Alfred Bell Cup, and the Edwardson Cup Final, again won by Backworth Welfare having defeated Ponteland in the semi-final by 53 shots to 31. Ponteland "A" team were runners-up to Benfield in the Jubilee Cup Final. PBC won the Public Utilities President's Knock-out Cup.**

**In 2018, PBC hosted the Edwardson Cup Final, won by Portland.**

In 2019, PBC hosted the Under 18 Singles final, a Triples semi-final. Also, on the same day, both semi-finals and final of the Edwardson Cup, won by St Georges.

In 2021, PBC hosted the Edwardson Cup Final, won by Benfield.

In 2022, PBC hosted the Edwardson Cup Final, won by New Delaval Knights. PBC won the Parliamentary League Division 2 title and were promoted. The Knight Cup League team were runners-up in Division 2 and promoted.



**Jubilee Cup Winners, 2010**

**(l -r) : Tom Harrison, Percy Telfer. Richard Varley and Bob Liddle**



**Northumberland Challenge Cup Competition Runners-up, 2011**

**(l - r) : D.C. Crozier, W.R. Liddle, M.L. Brennan, J.D. Cowings (President),  
E. Kelly, R.J. Varley, D.W. Kirk, M. Buggy (BN, IPP) and D. Franks**



**Public Utilities President's Knockout Cup Presentation, 2017**

**(l-r) : John Anderson (Benfield), President Dave Kirk and Jenifer Nixon**

**In 2023, PBC hosted the first round of the Challenge Cup. PBC also hosted, on the same day, both semi-finals and the final of the Edwardson Cup, won by Gosforth. The final of this competition has been held at Ponteland for the 26th consecutive occasion. Ponteland "A" team promoted to Division 1 in the Public Utilities League.**

## **2.2 Ladies' Section**

**Following the formation of the Ladies' Section in 1967, the ladies were engaged only in social-playing activities as there were no league matches. In 1975, the Men's Secretary arranged for the Ladies' Section to participate in three home friendly matches, on separate rinks, and the weekly Mixed Jumble events. The most popular friendly matches in the mid-1970s were the mixed rinks matches arranged with the Scottish Border Clubs, Stow and Galashiels.**

**In 1984, PBC entertained the Malvern, Worcs Ladies' B.C., and hosted the Northern Ladies' Evening League Gala Day. Also, in 1984, PBC entered the Collins & Shipley League competition in fine style, by winning all the match points in their opening game against New Delaval. On winning the Division 2 title they had an incredible shot difference of + 427 out of the total of + 454 shots in the league.**

**In 1987, PBC won the C. & S. League and entertained Malvern, Worcs Ladies' B.C.**

**In 1988, PBC won the C. & S. League, and entertained two teams from ICI, Welwyn Garden City, Herts, and Kislingbury, Northants**

**In 1990, PBC won the NEEPCL Ladi Gala Day Trophy.**

**In 1992, PBC won the C. & S. League.**

In 1993, PBC entertained two teams from Wigton B.C., Cumbria and Dunnington B.C., Yorks.

In 1994, PBC entertained a Devon touring team, the hosts narrowly winning the match.

In 1995, PBC won the C. & S. League and the NEEPCL Ladies' Gala Day Trophy.

In 1996, PBC entertained Worcester Tourists, the visitors winning the match by 5 shots.

In 1998, PBC hosted the NEEPCL Ladies' Gala Day competition.

In 1999, PBC won the C. & S. League.

In 2003, PBC participated in the North Eastern Ladies' Bowling League (NELBL).

In 2007, PBC won the C. & S. League.

In 2010, PBC won the C. & S. League.

In 2014, PBC were runners-up in the C. & S. League, Division 1.

In 2017, PBC won the NELBL.

In 2018, PBC won the C. & S. Division 1 and the NELBL.

In 2019, PBC again won the C.& S. Division 1 league and were runners-up in both the NELBL and Public Utilities competitions.

In 2022 and 2023, PBC were runners-up in the C. & S. League, Division 1.



**Public Utilities President's Knock-out Cup Winners, 2017**

**(l - r) J. Nixon, D. Thompson, D. Franks, J. Barras, J. Taylor and W. Howard**



**NCWBA Collins & Shipley League Winners, 1987**

**Back Row (l - r) : F. Owen, B. Stafford, J. Nichol, M. Barclay and E. Newton  
 Front Row (l - r) : M. Little, N. Rutherford, K. Armstrong, M. Scarlett, J. Graham,  
 M. Duff, N.F. Orton (President), M. Myers, I. Fletcher, W.O. Carse,  
 T. Wright, L. Stockman, M. Shuttleworth and B. Johnston**



**NCWBA Collins & Shipley League Winners, 1988**

**Back Row (l - r) : E. Newton, F. Owen, N. Rutherford, N.F. Orton, D. Crofts,  
 B. Stafford, I. Fletcher, T. Wright, M. Myers and  
 M. Shuttleworth  
 Front Row (l - r) : D. Lumley, M. Little, J. Graham, B. Johnston (President),  
 W.O. Carse and M. Duff**





**NCWBA Collins & Shipley League Winners, 1995**

**Back Row (l - r) : D. A. Johnson, I. Fletcher, N. Rutherford, M.E.H. Nesbit,  
F. McDonald, M. Lowthian, R. Edwards, M. Myers,  
W.O. Carse and M. Bryson**  
**Front Row (l - r) : J. Nichol, T. Wright, A. Gill (President), E. French,  
F. Owen, M. Shuttleworth and L. Telfer**



**BN Collins & Shipley League One Winners, 2019**

**Back Row (l - r) : O. Driver, P. Varley, M. Cowan, A. Rutter, J. Dineen,  
E. Cowings, G. Stapylton, L. Marsh and I. Young**  
**Front Row (l - r) : S.A. Storey, E. Emmerson, J. Nixon, C. Davison,  
A. Brennan and M. Turner**

## 2.3 Friendly Fixtures

Section 2.3.1 refers to Clubs' who participated in regular friendly matches with Ponteland. Unfortunately, several of these Clubs' are no longer in existence. The date of the inaugural fixture with each Club (1935 onwards) is given in parenthesis. Section 2.3.2 refers to fixtures arranged with touring teams.

### 2.3.1 Regular Fixtures

Alwick (1947)  
Amble (1950)  
Andrew's (1946)  
Belgrave (1952)  
\*Castle Ward R.D.C. (1963)  
\*Castle Morpeth Mayor (1979)  
Coldstream (2003)  
Electricity Board (1958)  
Denton Burn (2016)  
Falcon (1974)  
Forest Hall (1968)  
Galashiels (1975) - Established 1858  
Gateshead (1957)  
Gosforth West Avenue (1952)  
Gosforth Central (2004)  
Haltwhistle (1949)  
Heaton L.N.E.R. (1939)  
Hexham Elvaston (1959)  
Inbetweeners (2013)  
Inisfree (2018)  
Kenton (1939)  
Lesbury (2004)  
Linskill (1952)  
Lyndhurst (1972)  
Morpeth (1954)  
M.P.N.I. (1959)  
\* Northern Rock B.S. (1975)  
\* Northumberland Police (1993)  
\* Ponteland Town Council (2009)  
Portland (1974, the year of their Centenary Celebrations)  
The Press (1935)  
Prudhoe Castle (1993)  
Prudhoe Veterans (1978)  
Rothbury (1947)  
Ryton (1975)  
Ryton Veterans(1993)  
Seahouses (1998)  
South Shields Highbury (1939)  
Stow (1975)  
Summerhill (1944)  
Sunderland (1975)  
Westerhope (1946)  
Wooler (1950).

\* Social Club matches

### 2.3.2 Tourists

- Bedford Borough (1995)
- Bedford Police (1986)
- Bowls England President's Tour (2009 & 2023)
- Devon County Ladies' Tourists (1995)
- Dunnington, Yorkshire (1993)
- \*\*\* Gosforth Bowlers Touring Club (1995)
- Keyworth, Nottingham (2011)
- Kislingbury, Northants (1998)
- Leicester Tigers (1994)
- London Parks B.A. (1987)
- Maryport, Cumbria (2010)
- \*\* NCBA HVPAs (1994)
- NCBA League (1955)
- Norfolk County Ladies' Tourists (2004)
- Norfolk Police (1991)
- Perth (1983)
- Potterton International, Warwicks (1999)
- Retford Town, Notts (1989)
- Shefford, Beds (1989)
- Surrey Tourists (1956)
- Welham, Yorkshire (1955)
- West Edinburgh, Midlothian (1987)
- West Midlands Police (1986)
- Wigton, Cumbria (1993)
- Worcester Ladies' Tourists (1996).

\*\* In 1992, the Northumberland Honorary Vice Presidents Association (HVPA) was formed and is a separate but integral organization of the newly named Bowls Northumberland (BN). Since 1994, PBC has regularly hosted an HVP fixture. Membership is available to any member of a club which is affiliated to BN. The HVPA provides benefits of games and social activities including County HVP matches with host clubs and inter-County HVP matches. A list of the names of HVPs first appeared in the NCBA Year Book in 1962. An annual minimum donation of £1 is paid into the BN Benevolent Fund.

\*\*\* The Gosforth Bowlers Touring Club (GBTC) was founded in 1922. The annual weekly tour, with the exception of the WW II years, had twice taken place in Ireland until 1936, but mostly in Scotland until 1962, and, thereafter, in England. PBC has entertained teams from the GBTC since 1995. In chronological order, the following Ponteland members, have participated in some of the GBTC tours to popular holiday resorts in southern England. The year of the first tour made by PBC members is indicated in parenthesis, and the asterisk indicates their captaincy of a tour. B.D.W. Wright accepted the Hon. Secretary position in 1983.

- \*J. Oliver (1968), \*R.F. Pascoe (1968), J.A. Main (1973), B.D.W. Wright (1976),
- \*J. English (1977), W. Wilson (1980), \*A.H. Baker (1981), \*R. Elder (1981),
- J.W. Atkinson (1984), \*S.A. Swift (1986), D. Hindmarsh (1987), \*J. Lunn (1987),
- \*J.W. Nesbit (1989), \*G. Skinner (1989), P. Cordingley (1990), E.S. Johnson (1991),
- D. Boland (1992), E. Marshall (1995), E.W. Lowthian (1997), R.A. Peckham (1997),
- R. Lyon (1998), C. Bryson (1999), C. Walters (1999) and M.L. Brennan (2010).



**Gosforth Bowlers Touring Club. Devon Tour, 1980**

**Standing (l- r) : J. Armstrong (SL), R.H. Wilson (PD), W. Wilson (Ponteland),  
A. Topping (PD), J.I. Elder (BK), A.A. Clarke (PD), J. Oliver (PD),  
I.G. Story (PD), B.D.W. Wright (Ponteland), G.E. Fenwick (PD),  
W.G. Gray (BK), T.H. Nichol (HX), G.D. Varty (PD), W.H. White (BK)  
W.J.B. Carr (PD) and R.F. Pascoe (PD)**

**Seated (l- r) : G. Shaw (PD), J.A. Main (Ponteland), H. Ogle ( PD),  
J. English (Ponteland) and J.E. Alexander (G)**

**Key to other Clubs :**

**BK - Berwick , G - Gosforth, HX - Hexham, PD - Portland, SL - Summerhill**



**PBC Members on Gosforth Bowlers Tour to Kent, June 1992**

**Back Row (l- r) : J. English, G. Baston (Hexham) and R. Elder  
Front Row (l- r) : S.A. Swift, S. Palmer (Portland) and J.W. Nesbit**



**Bowls England President's Tour, 5<sup>th</sup> July, 2009**

**PBC Team (l - r) : R. Donkin, W.R. Liddle, D. Hudson, R.I. Shuttleworth, J.T. Harrison, P. Telfer, R. Rutter, N. Green, J. Gatenby, D.G. Kennerley, D. Carr, D.W. Morrison, R.A. Peckham, D. Franks, E. Scholes, M.L. Brennan, J. Waller, J.D. Cowings, D. Downing, H. Robson (President), J.S. Varley, F. Marshall, M. McDonnell, E.W. Lowthian, A. Ridley, F. Knight (BE Sub.) and D.W. Kirk**



**PBC v. Bowls England President's Tourists, 5<sup>th</sup> July, 2009**



President Harry Robson with BOWLS ENGLAND President, Dennis Cousins

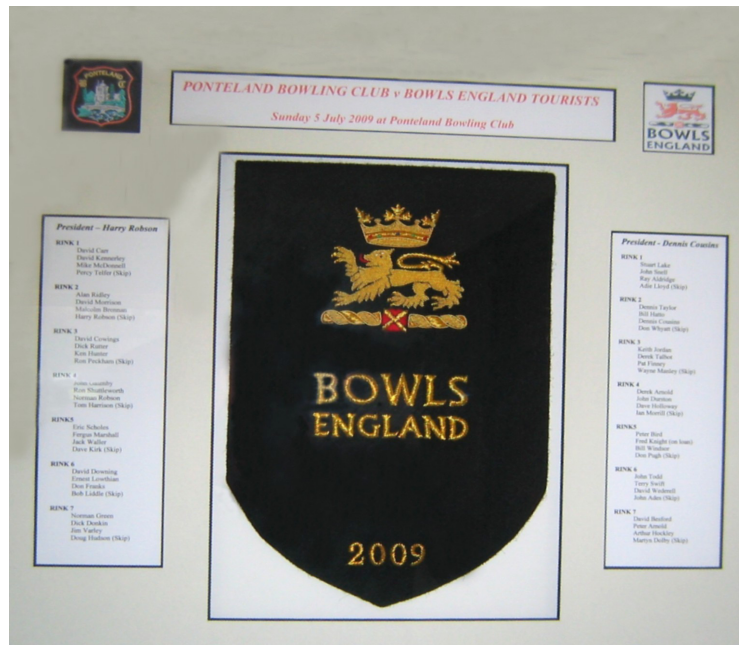

**Ponteland**

**Tourists**

Participating Teams, 5<sup>th</sup> July, 2009

# 3

## PBC Domestic Competitions

### 3.1 Men's Section

During its early years, there were four main competitions with prize-winners usually receiving monetary gifts. In the Singles 4-Bowl Championship, the winner received the Welsh Memorial Cup but a gift of one guinea was awarded to the runner-up, and a half-guinea to each to the semi-finalists. After 1934, the Club champion received two guineas and the Welsh Memorial Cup. At that time, such a sum was probably a working man's wages for a week.

In the 2-bowl Handicap, the winner received one guinea and the runner-up a half-guinea. After 1934, the semi-finalists each received 6s. 0d.

In the Milne Challenge Cup (won outright in 1934 by J.H. Allison), the winner received one guinea and the runner-up received a half-guinea. In 1935, the winner of the replacement trophy, the Milne Rose Bowl, also received one guinea, the runner-up a half-guinea and each semi-finalist 6s. 0d.

In the Consolation Handicap, the winner received a half-guinea and the runner-up 6s. 0d. After 1934, the monetary gifts were the same as for the 2-Bowl Handicap competition. This competition, however, was discontinued in 1946.

In the Spoons competition played on Saturday evenings, two players with the best aggregate scores at the end of the season each received a half-guinea. The monetary prizes for this competition were discontinued in 1939.

In 1936, both Pairs and 3-men Rink competitions were introduced. The Pairs winners each were receiving a half-guinea, the runners-up each having 6s. 0d, and the Rink winners each receiving 2s. 6d. The Rink competition was ended in 1938, due to lack of support.

Club competitions were discontinued in the war years, 1940-1943, with the exception of the Spoons competition which proved a great attraction on Saturday evenings. However, in 1942, it was decided to award winners of the Saturday evening Jumbles with National Savings stamps of value 2s 6d in lieu of the increasingly expensive silver spoons.

In 1944, the Singles competition for the Welsh Memorial Cup was re-introduced. In 1946, all competitions except the Pairs and Consolation Handicap were resumed.

In 1945, the President, J. Henderson, presented a trophy to be known as the VE Cup in recognition of the victory of the Allies in the war in Europe. It would be presented to the winner of an annual 4-bowl handicap competition, with prize monies as for the Club championship. An entrance fee of 1s. 0d was required, with the proceeds that year going to the Red Cross Fund. In 1965, this trophy was awarded to the runner-up in the final of the Club Singles competition.

In 1948, two William Wilson Memorial cups were presented to the Club for the winners of the domestic Pairs competition. Due to fund constraints, the prize monies for the Club competitions were halved in 1948.

In 1950, the Wm M. Straughan Memorial Trophy was presented to the Club for a Saturday evening Jumbles competition. The trophy winner also received £1 with the

runner-up receiving 10s. 0d.

Prize-monies for the finalists in domestic competitions, with the exception of the Straughan Salver, were replaced in 1953 with medallions of equivalent value. This arrangement was not popular and prize-money was re-introduced in 1954.

In 1956, E. Moxon presented the Club with a cup (replaced with another cup by the donor in 1965) for a new Over 60 Handicap competition. Prize-money of £1 was awarded to the winner, 10s. 0d to the runner-up and two third prizes of 5s. 0d.

In 1961, the prize monies were reduced in all competitions with winners receiving £1 and the runners-up 10s. 0d. Prize-money was shared in the Pairs competition.

In 1963, P.L. Lloyd presented the Club with a splendid silver cup which is awarded to the winner of the 2-Bowl Singles competition.

In 1968, the fiasco of Men's domestic competitions not being properly supervised by the organising Committee resulted in only the Club championship and the Milne Rose Bowl competition being completed.

In 1975, Mrs D. Emery presented the Club with silver salvers for the winners of the inaugural Harry Emery Memorial Mixed Pairs competition, the Secretary having made the oak plinths. The runners-up received miniature wine coolers.

Annual Prize Presentations were held in the PMH in the 1970s and invitations were sent to the County President, the County Secretary and their wives.

In 1978, it gave much pleasure to members when W. Middlemiss, aged 86, won the Over 60 Handicap competition. In 1979, the finalists in the domestic competitions were given the option of a gift token equivalent to the value of the medallions or plaques normally awarded.

In 1980, an entry fee was made payable in the Straughan Salver competition as some members were accepting the option of prize-money of £1 rather than the customary silver spoon.

In 1985, the Lloyd Cup 2-Bowl Singles competition rules were changed. The early rounds would be played over 15 ends and both the semi- and final rounds played over 21 ends. Also, in 1985, a new Mixed Triples competition was sponsored by Guardian Royal Exchange. In 1986, the President, Ron Elder, presented the Club with three trophies for the Mixed Triples competition.

In 1980, an entry fee was made payable in the Straughan Salver competition as some members were accepting the option of prize-money of £1 rather than the customary silver spoon.

In 1985, the Lloyd Cup 2-Bowl Singles competition rules were changed. The early rounds would be played over 15 ends and both the semi- and final rounds played over 21 ends. Also, in 1985, a new Mixed Triples competition was sponsored by Guardian Royal Exchange. In 1986, the President, Ron Elder, presented the Club with three trophies for the Mixed Triples competition.

In 1987, the rules for the Lloyd Cup 2-Bowl Singles competition were changed to playing the best of three sets with a scoring system of the first to reach seven shots per set. Also, in 1987, the President, John Nesbit, presented the Club with a cup for a Ladies and Men's Pairs competition.



In 1992, J.W. Atkinson provided the Angora Cup for members not having won any of the domestic Club competitions. Also, the Stan Wright Memorial Trophy was presented to the Club by Mrs T. Wright "as a 1- day fun event".

In 2000, the Lloyd Cup 2-Bowl Singles competition reverted to the original rules of the first player to reach 21 shots.



**Men's Section Annual Prize Presentation, October 1975**

**Guests : NCBA President Ian Drysdale ( Whitley & Monkseaton B.C.)  
and Mrs Ann Drysdale**



**Men's Section Annual Prize Presentation, October 1976**

**Guests : Mrs Joan Coan, NCBA Secretary, Gordon Tate, Mrs Edith Tate,  
NCBA President, Rowland Coan ( Summerhill B.C.) and  
Bernard Wright (President)**

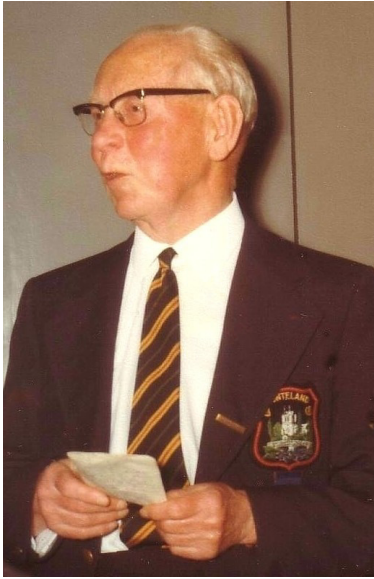

**John Lees  
President**



**Gordon Tate (Gosforth B.C.)  
NCBA President**

**Men's Section Annual Prize Presentation, October 1977**



**Men's Section Annual Prize Presentation, October 1978**

**(l - r) : Bernard Wright (Secretary), Mrs Edith Tate, Jim Roberts,  
NCBA Secretary, Gordon Tate (Gosforth B.C.) and  
NCBA President, Frank Moir (Alnwick B.C.)**

**In 2002, a "Tens" competition for the Armstrong Trophy was introduced in memory of past members, Brian and Kathleen. The inaugural event, comprised of one team of Singles, Pairs, Triples and Fours from the Ladies' Section against one team from the Men's Section. The Men's Section narrowly won the match. Some of the matches during the period 2002- 2023 were quite closely contested but resulted in the Men's team winning on 15 occasions to 3 by the ladies.**



**Men's Section Annual Prize Presentation, October 1979**

(l - r) : J.S. Duff, D.L. Walker, NCBA President Tom Cook ( Portland B.C.),  
T. McPhee (President), A. Young, E. Scholes, J. English and  
J.W. Atkinson

**N.B. An album containing a series of photographs of the Men's Section Annual Prize Presentations from October 1975 - October 1978 is available in the PBC archives.**

### **3.1.1 Notable Achievements**

There have been many notable bowling achievements by members over the years. The most consistent players made regular County appearances over the years. They are mostly referred to in Sections 5.1 and 6.1.

In connection with the domestic competitions, the results of which are given in Section 11.1, undoubtedly, the most successful player in the Men's Section was Michael Bennett who joined the Club as a junior, aged 14 years, in 1979. He made thirteen appearances in the final of the Club championship in seventeen years, narrowly losing his first final at the age of 16, and winning on eleven occasions (nine of these consecutively). Furthermore, he won five other Singles competitions and jointly won another five competitions. Thereafter, he has won Singles titles at other clubs on leaving Ponteland in 1999. Two other outstanding bowlers at the Club were Tom Cuthbert and Tom McPhee winning 18 and 19 domestic Singles titles respectively over 35 years. Dave Morrison appeared in all four finals of the domestic Singles competitions in 2015. By winning three and narrowly losing the fourth he was undoubtedly the most competitive Secretary in the Club's history. Newcomers to the Club in recent times have performed very well in the domestic competitions. Ian Cahill, a new member in 2021, appeared in three Singles finals in 2023 winning on two occasions.

## **3.2 Ladies' Section**

Inaugural dates of the domestic competitions are shown in parenthesis. The Ladies' Section participate in three domestic Singles competitions, viz. the 2-Bowl

(1972), the 4-Bowl for the Elizabeth Pascoe Rose Bowl (1977) and the 3-Bowl for the Lilian H. Loughton Cup (1982). In connection with the 2-Bowl competition, it was pointed out at the 1983 AGM that these matches should be played over 21 ends and not the first to reach 21 shots, as hitherto.

Other competitions include the Pairs (1980) and the Joyce Carmichael Memorial Cup Triples (1986). Also, the overall winner of the Jumbles weekly competitions is awarded the Nan MacLeod Salver (1983).

In 1997, the Rainbow Trophy was introduced in an attempt to encourage more members to participate in the domestic knock-out competitions.

The Ladies' Section have participated in nine domestic mixed events. In recent years only five competitions take place viz. Ron Elder President's Mixed Triples (1985), John Nesbit Ladies' v. Men's Pairs' (2001), Joint Presidents' Day (2004), Telfer Open Pairs (2005) and the end-of-season' Tens' Armstrong Trophy (2002) match against the Men's Section.

### 3.2.1 Notable Achievements

The achievements of Lady members in County competitions and representative matches are mostly referred to in Sections 5.2 and 6.2.



**Ladies and Men's Competition Winners, 1987**

**Back Row (l - r) : T. McPhee, G.D. Bennett, Mrs M. Little, M. Wearmouth, J. Lunn, T. Nichol and B. Armstrong**

**Middle Row (l - r) : Mesdames E. Scott, F. Owen, N.F. Orton (President), T. Wright, L. Stockman, M. Myers and M. Duff, J.S. Duff and Miss W.O. Carse**

**Front Row (l - r) : J.W. Nesbit (President), Mesdames I. Fletcher, J. Graham and M. Shuttleworth, M.A. Bennett and S. Rutherford**



### **Ladies and Men's Competition Winners, 1988**

**Back Row (l - r) : Mesdames D. Crofts, T. Wright and M. Scarlett,  
A.M. Maclean, Mrs. M. Baker, W. Robinson,  
Mesdames B. Stafford and G. Cattliff, S. Rutherford,  
S. Wright and R. Stafford**

**Middle Row (l - r) : Mesdames M. Little, D. Lumley, J. Graham,  
B. Johnston (President), M. Shuttleworth, I. Fletcher,  
F. Owen and M. Stuart**

**Front Row (l - r) : L. Crofts, T.W. Cuthbert, S.A. Swift (President) and  
T. Lumley**

**Results of the ladies' domestic competitions are included in Section 11.2. Undoubtedly, the most successful bowler has been Maria Shuttleworth who joined the Ladies' Section in 1979. She was the winner of 23 Singles competitions, comprised of the 4-Bowl title on twelve occasions, the 2-Bowl title on four occasions, and the 3-Bowl title on another seven occasions. In addition, she was a joint winner in twelve other competitions totalling 35 titles in 24 years. In addition to two National titles, Maria won six County Singles titles and was a joint winner of four titles between 1987 - 2001, also, representing the County from 1988 - 2002.**

**M. Little and J. Graham excelled in domestic Singles competitions, each winning seven titles, and were joint winners in other competitions on five and four occasions respectively. Joan Graham was prominent in both County administration and personal bowling success alongside National umpiring duties.**

# 4

## Northumberland Executive Committees

### 4.1 NCBA

In November 1951, J. Oliver was elected a member of the NCBA League Management Committee and its Vice-Chairman in November 1952.

In November 1953, J. Oliver was elected the Chairman of the NCBA League Management Committee for 1954. He continued to serve as a Committee member until the end of the 1962 season.

In November 1958, J. Oliver was elected a member of the NCBA General Purposes Committee and remained in office until the 1973 season.

In November 1964, R.F. Pascoe was elected the Auditor of the NCBA and remained in office until his resignation in 1981.

In November 1965, J. Oliver was re-appointed a member of the League Management Committee, subsequently resigning from the Executive in 1972.

In November 1965, J. Oliver became the first member of the Club to be elected the Junior Vice President of the NCBA in 1966 and also the Senior Vice President in 1967. In November 1967, J. Oliver was elected the President of the NCBA. To mark the occasion, a copy of the photograph which appeared in the 1968 NCBA Handbook, was placed in the Pavilion following the request of R.F. Pascoe at a GPC meeting, held in February 1968.

At the 1976 NCBA League Spring meeting, B.D.W. Wright proposed the awarding of rink points in the Clegg Cup and Knight Cup matches. His proposal had previously been accepted at the inaugural meeting of private clubs in the NEEPCL. It would provide a more competitive edge on the individual rinks, with the opportunity of earning some points in a match seemingly lost.

The motion was favourably received for it to be reconsidered at the next AGM. However, at that meeting, although the motion was carried the League Secretary stated there was too much arithmetic involved and he would resign if the proposal was adopted. A second vote was taken and the motion was lost. Hector Woodman retired from the position of League Secretary in 1981, having served the County for 32 years. Interestingly, 14 years later, a new scoring system with the awarding of rink points was introduced in the Clegg Cup and Knight Cup competitions.

In November 1976, B.D.W. Wright was elected a member of the NCBA League Management Committee until 1978, when its affairs were embodied in the NCBA following a change in its Constitution.



Joe Oliver  
NCBA President, 1968

In November 1978, B.D.W. Wright was elected a member of the NCBA General Purposes Committee, but subsequently resigning from the Executive during the 1981 season having professional career commitments.

In November 1982, J. English was elected the Auditor of the NCBA and remained in that office until November 1989 when he was elected the Junior Vice-President of the NCBA. For reasons of health, however, he did not seek election for the office of Senior Vice President in 1990.

Early in 1992, E.S. Johnson was invited by the County GPC to take over the position of Junior Vice President and was elected Senior Vice President of the NCBA, at the AGM in November 1992. Tragically, shortly after his election, he died following an accident at his home. Whilst in office, he was responsible for the design and purchase of the County umbrellas which are still to be seen on rainy days.

In November 1993, R.I. Shuttleworth was elected a member of the NCBA General Purposes Committee, and elected as the League Secretary in May 1997, subsequently resigning from the Executive in 2004.

## **4.2 NCWBA**

At the AGM in November 1984, I. Fletcher was elected Treasurer of NCWBA.

At the AGM in November 1989, B. Johnston was elected Junior Vice President of NCWBA and Senior Vice President in 1990.

At the AGM in November 1991, B. Johnston became the first member of the Ladies' Section to be elected President of NCWBA.

At the AGM in November 1995, M. Shuttleworth was elected Assistant Competitions Secretary of NCWBA.

In November 1996, N. Rutherford was elected Junior Vice President of NCWBA and Senior Vice President in 1997. In November 1998, N. Rutherford was duly elected President of NCWBA and served during its 50th Anniversary. It must be an unusual occurrence for a County President not to have previously served as President of an affiliated bowling Club. During her presidency in 1999, six NCWBA competitions were held in Ponteland and she led a tour of County Down, N. Ireland.

In November 2002, N. Rutherford was elected a member of NCWBA Selection Committee, and served continuously until her retirement in 2006.

At the AGM in November 2007, D.A. McDonnell was elected Junior Vice President of NCWBA and Senior Vice President of the renamed Bowls Northumberland in 2008. Subsequently, in November 2009, D.A. McDonnell became the third member of the Ladies' Section to be elected President of the County. During her presidency, eight County competitions were held in Ponteland including a Bowls Northumberland Ladies' match against a winning BN Men's team.

At the AGM in November 2011, G. Stapylton was elected Junior Vice President of Bowls Northumberland, and subsequently, in November 2013, elected President of BN.

At the AGM in November 2019, S.A. Storey was elected Junior Vice President of Bowls Northumberland. and subsequently, in November 2021, elected President of BN.



**Betty Johnston**  
**NCWBA President, 1992**



**Noreen Rutherford**  
**NCWBA President, 1999**



**June Nichol (2nd from right), Betty Johnston (3rd), Lorna Telfer (6th),  
 Betty Nesbit (10th) and Elizabeth French (9th from left)**

**Seated : Noreen Rutherford (President)**

**Noreen Rutherford's NCWBA President's Tour of County Down, N. Ireland, 1999**





**Di McDonnell**  
**BOWLS Northumberland President, 2010**



**Gloria Stapylton**  
**BOWLS Northumberland President, 2014**



**Allison Storey**  
**BOWLS Northumberland President, 2022**

# 5

## Northumberland Fixtures and National Competitions

### 5.1 NCBA

In 1949, W. Hepple, J. Oliver, J.M. Moorhead and W. Wilson were runners-up in the County Rinks competition and represented the County in the EBA National Finals held in Mortlake, London.

In September 1950, PBC hosted its first County Alsop Cup match against Yorkshire which Northumberland won by 40 shots, 150-110. Changing facilities and refreshments were provided in the PMH, and at all future County occasions.

In May 1952, PBC hosted the Middleton Cup match against Yorkshire which Northumberland won by 9 shots, 108-99. Also, J. Oliver and E. Forster were runners-up in the 1952 County Pairs competition and qualified to play in the EBA National Finals held in Mortlake, London.

In June 1954, PBC hosted the Alsop Cup match against Durham which Northumberland won by 13 shots, 116-103.

In May 1956, PBC hosted the Alsop Cup match against Durham, the visitors winning by 11 shots, 121-110. Also, in 1956, M. Johnstone became the first PBC member to win the County Singles title, and in recognition of this achievement, the Club presented him with a pair of bowls suitably inscribed to mark the occasion.

In June 1958, PBC hosted the NCBA President's match against East Hertfordshire which Northumberland won by 12 shots, 121-109.

In June 1959, PBC hosted the Alsop Cup match against Yorkshire which Northumberland won by 59 shots, 142-83.

In May 1961, PBC hosted the Alsop Cup match against Durham which Northumberland won by 15 shots, 123-108.

In May 1962, PBC hosted the Alsop Cup match against Durham, the visitors winning by 25 shots, 124-99.

In 1963, T.W. Cuthbert won the County "Champion Of Champions" Deuchar Cup competition whilst J. Oliver, W. Mole and J. Nielson won the annual Hastings Triples tournament.

In July 1964, PBC hosted the Alsop Cup match against Cumberland which Northumberland won by 42 shots, 145-103.

In June 1965, PBC hosted the Alsop Cup match against Cumberland, the visitors winning narrowly by 2 shots, 122-120. M. Johnstone won the private clubs' J.M. Oubridge Cup competition.

In June 1966, PBC hosted the Alsop Cup match against Durham which Northumberland won by 20 shots, 129-109. PBC also staged its first NCBA Vice President's match.

In 1967, PBC hosted the Alsop Cup match against Yorkshire which Northumberland won narrowly by 4 shots, 123-119.

In 1968, J. Oliver, the NCBA President, and R.F. Pascoe won the County Pairs title. Also, M. Johnstone won the private clubs' J.M. Oubridge Cup competition at Ponteland. In July 1968, PBC hosted the Alsop Cup match against Cumberland which Northumberland won by 25 shots, 129-104. In August 1968, PBC hosted the Alsop Cup match against Durham, the visitors winning by 21 shots, 126-105. Also, PBC hosted the County Hon. Vice President's match against Yorkshire Patrons.

In 1969, T.W. Cuthbert and T. McPhee were runners-up in the County Pairs competition.

In 1971, PBC hosted the County Hon. Vice President's match against the Yorkshire Patrons.

In 1973, PBC hosted the County Hon. Vice President's match against Yorkshire Patrons. The County Pairs title was won by J. Oliver and R.F. Pascoe for the second time.

In 1975, PBC hosted the Northern Counties Armstrong Trophy match against Yorkshire, the visitors winning by 14 shots, 126-112. J.A. Main and A. Young were runners-up in the County Saga Over 60s Pairs competition.

In 1976, T. Martin won the private clubs' J.M. Oubridge Cup competition at Berwick.

In 1977, T.W. Cuthbert and T. McPhee won the County Pairs title.

In 1978, T.W. Cuthbert won the private clubs' J.M. Oubridge Cup competition at Gosforth West Avenue.

In 1980, T.W. Cuthbert again won the private clubs' J.M. Oubridge Cup competition and M.A. Bennett won a County Junior Singles competition.

In 1985, M.A. Bennett won both the County 25-and-under and Northern Counties Singles competitions. Also, for the first time, M.A. Bennett, F. Holt and S. Rutherford won the final of the NCBA Triples competition against Whitley and Monkseaton. It is interesting that Ponteland won, for the first time, both the County Men and Ladies Triples titles in the same year. Coincidentally, the Men's team included S. Rutherford, and the Ladies' team included his wife, N. Rutherford.

In 1987 and 1988, M.A. Bennett as in 1985, won the County 25-and-under Singles competition.

In 1989, M.A. Bennett won the County "Champion of Champions" Deuchar Cup competition.

In 1993, in support of member E.S. Johnson, the NCBA Senior Vice President, PBC hosted the Alsop Cup match against Yorkshire, the visitors winning by 10 shots, 135-125. Also, M.A. Bennett won the County Singles title against a former England International, M. London (Summerhill), and went on to reach the quarter-finals of the EBA National championships, held in Worthing, Sussex.

In 1994, PBC hosted a heat of the County Singles 2-Bowl competition. The final of the competition was won by M.A. Bennett. Also, with K.D. Wood, he went on to win the County Pairs title and the National Pairs Tom Yeoman Trophy at the EBA National championships held in Worthing, Sussex. They represented England in the British Isles Championships in 1994 winning the Pairs title.



**NCBA Triples Trophy Winners, 1985**  
(l - r) : Michael Bennett, Stan Rutherford and Frank Holt

**In 1995, M.A. Bennett won the private clubs' J.M. Oubridge Cup competition.**

**In 1997, M.A. Bennett again won the private clubs' J.M. Oubridge Cup competition. PBC hosted a heat of the County Singles 2-Bowl competition.**

**In 1999, PBC hosted the Alsop Cup match against Yorkshire which Northumberland won by 31 shots, 134-103. PBC also hosted a heat of the County Singles 2-Bowl competition.**

**In 2000, PBC hosted the Alsop Cup match against Durham which was won by Northumberland by 8 shots, 128-120.**

**In 2007, PBC hosted the Northern Counties Armstrong Trophy match against Lancashire which Northumberland won by 39 shots, 130-91. PBC also hosted Stage One of the County 2-Bowl Singles competition.**

**In 2008, PBC hosted the Northern Counties Armstrong Trophy match against Cumbria which was played in very wet conditions, Northumberland winning by 9 shots, 60-51 (4 rinks). PBC also hosted Stage One of the County 2-Bowl Singles competition.**

**In May 2009, the delayed 2008 private clubs' J.M. Oubridge Cup competition was won by R.A. Peckham.**

**In 2009, PBC hosted their final Northern Counties Armstrong Trophy match against Lancashire which Northumberland won by 53 shots, 111-58 (4 rinks). This competition was first held in 1973 but ended in 2009.**

**.In 2011, R.J. Varley won the BN "Champion of Champions" Deuchar Cup competition and a new member, D.C. Crozier, was runner-up in the private clubs' J.M. Oubridge Cup competition.**

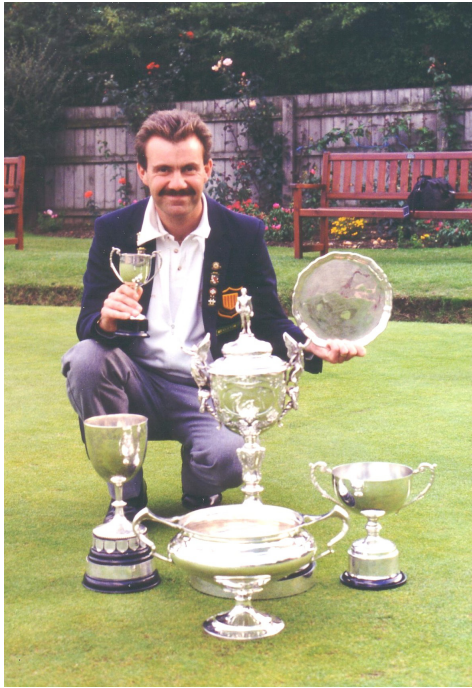

**Michael A. Bennett**  
Ponteland's Most Successful Bowler with both County and National Honours, 1994, also International Honours, 1995 and 1997



**Michael A. Bennett and Keith D. Wood**  
EBA Pairs Trophy Winners, 1994 and British Isles Pairs Champions, 1995



**PBC Members in BN Northern Counties Armstrong Team, 2009**  
Front Row : Richard Varley and Bob Liddle

In 2012, D.C. Crozier was runner-up in the County "Champion of Champions" Deuchar Cup competition.

In 2013, D.W Morrison was runner-up in the private clubs' J.M. Oubridge Cup competition.

In 2017, PBC hosted the BN Alsop Cup match against Cumbria which BN narrowly won by 2 shots, 114- 112.

In 2018, PBC hosted three Northern Counties Cup matches. Two Muras Cup matches were held on the same day viz. BN v. Durham and BN v. Yorkshire. The third match was an Alsop Cup fixture BN v. Yorkshire.

In 2019, PBC hosted the BN Alsop Cup match against Yorkshire. BN had a convincing win by 26 shots, 131-105. PBC also hosted the private clubs' J.M. Oubridge Cup, won by R.J. Varley.

### 5.1.1 Other Competitions

In 1963, J. Oliver, W. Mole and J. Nielson won the annual Hastings Triples tournament.

In 1909, J.M. Oubridge, a member of Portland Bowling Green Club, donated two cups for a competition between the Champions of the private clubs in Northumberland and of the N&DBA. In 1945, W. Wilson, the nurseryman in Callerton Lane, was presented with a suitably inscribed gold medal by PBC in recognition of his winning the prestigious N&DBA J.M. Oubridge Cup.

Eight PBC members have participated in eleven finals of the Northumberland J.M. Oubridge Cup competition :

Date	Champion	Runner-Up
1965	M. Johnstone	-
1968	M. Johnstone.	-
1976	T. Martin	-
1978	T.W. Cuthbert	-
1980	T.W. Cuthbert	-
1995	M.A. Bennett	-
1997	M.A. Bennett	-
2009	R.A. Peckham	-
2011	-	D.C. Crozier
2013	-	D.W. Morrison
2019	R.J. Varley.	

In 2000, the Men's Section first participated in the Parliamentary League. It also holds a "Champion of Champions" competition which PBC entered in 2023 and was won by D. Burbeck.



**Ron Peckham, Winner of the  
J.M. Oubridge Cup, 2008**



**Richard Varley, Winner of the  
BN Deuchar Cup, 2011**



**Richard Varley, Winner of the  
J.M. Oubridge Cup, 2019**



**Don Burbeck, Parliamentary League  
Champion of Champions, 2023**

## 5.1.2 NCBA Presidents' Tours

The following PBC members were invited by NCBA Presidents to attend their annual tour :

Year	President	Location	PBC Attendees
1963	H. Woodman (NW)	Cheltenham	W. Mole & J. Oliver.
1964	S. Drysdale (WM)	Troon, Ayrshire	W. Mole, J. Oliver & R.F. Pascoe.
1965	W. Lindsay (AK)	Bedford	J. Oliver & R.F. Pascoe.
1966	F.J. Armstrong (WM)	Weston-super-Mare	J. Oliver & R.F. Pascoe.
1967	W. Ferguson (T)	Babbacombe	J. Oliver.
1968	J. Oliver (PE)	Tunbridge Wells	J. Loughton, W. Mole & R.F. Pascoe.
1969	H.V. Lightfoot (G)	Westcliff on Sea	W. Mole, J. Oliver & R.F. Pascoe.
1970	J.W. James (C)	Babbacombe	J. Oliver & R.F. Pascoe.
1971	C.W. Forster (AK)	Bournemouth	J. Oliver & R.F. Pascoe.
1972	W.C. Armstrong (NE)	Windsor	J. Oliver & R.F. Pascoe.
1973	G.A. Ward (HX)	Isle of Wight	J.A. Main, J. Oliver & R.F. Pascoe.
1974	G.H. Kinnersley (M)	Weymouth	J. Oliver & R.F. Pascoe.
1975	I. Drysdale (WM)	Weston-super-Mare	R.F. Pascoe.
1976	R. Coan (SL)	Worthing	J. Oliver & R.F. Pascoe.
1977	G. Tate (G)	Cliftonville	J. Oliver & R.F. Pascoe.
1978	F.J.R. Moor (AK)	Babbacombe	R.F. Pascoe & B.D.W. Wright .
1979	T. Cook (PD)	Eastbourne	J. Oliver.
1981	G.W. Riley (W)	Barry, Wales	J.R. Linley & G.D. Bennett.
1997	G.S. Borthwick (HS)	Cheltenham	R.I. Shuttleworth.
1998	W.L. Stoker (BW)	Bournemouth	R.I. Shuttleworth.
1999	J.E. Rennie (T)	Isle of Wight	R.I. Shuttleworth.
2000	A.J. Humble (WM)	Sidmouth	R.I. Shuttleworth.
2001	R. Sylph (NW)	Felixstowe	R.I. Shuttleworth.
2002	W.J. Gilbert (CN)	Frome, Bath	R.I. Shuttleworth.
2003	E. Lathan (HX)	Great Yarmouth	R.I. Shuttleworth.
2004	T. Kenny (CH)	Dunoon	R.I. Shuttleworth.
2005	E. Turnbull (AK)	Bournemouth	R.I. Shuttleworth.
2006	D.W. Kirk (NE)	Eastbourne	R.I. Shuttleworth.
2007	T. Foo (G)	Stratford	R.I. Shuttleworth.

### Affiliated Clubs

AK	Alnwick
BW	Backworth Welfare
C	Collingwood
CH	Chirton
CN	Cramlington
G	Gosforth West Avenue
HS	Health & Security
HX	Hexham Elvaston
M	Morpeth
NE	Northern Electric
NW	North Shields West End
PD	Portland
PE	Ponteland
SL	Summerhill
T	Tynemouth
W	Wallsend
WM	Whitley & Monkseaton



## 5.2 NCWBA

When Joan Graham joined the Club in 1983 the Ladies' Section was comprised of mostly social players. However, with her competitive qualities and presence on the NCWBA Executive, this led to Ponteland Ladies' becoming a force in both County and National bowling competitions.

In County and National competitions, J. Graham participated in thirteen finals covering seven different competitions and winning on ten occasions. Also, she regularly appeared in the County team, firstly when at Whitley & Monkseaton in 1955 and then at Cowpen & Crofton in June 1976. She joined Ponteland in 1983 and again appeared for the County until shortly before her untimely passing in 1996.

In County and National competitions, M. Shuttleworth participated in twenty finals covering nine competitions and winning on fourteen occasions. Sadly, having also regularly appeared in the County team from 1988, she was denied any further success with her enforced retirement in 2002. Details of the County competitions won by PBC Ladies are given below.

In 1985, the County Ladies' 2-Bowl "Champion of Champions" Singles title was won by J. Graham, and the County Ladies' Triples title with N. Rutherford and M. Little. These were the first County competitions to be won by members of Ponteland B.C.



**NCWBA Triples Trophy Winners, 1985**  
(l - r) : Noreen Rutherford, Joan Graham and Mary Little

In 1986, PBC hosted the Northumberland Ladies' match against Yorkshire. In the County Ladies' competitions, M. Little won both The Saga Over 55s 4-Bowl and 2-Bowl "Champion of Champions" Singles titles. J. Graham also won the 4-Bowl Singles title.

In 1987, PBC hosted the Northumberland Ladies' match, which was won in heavy rain, against Yorkshire. Also, the Club enjoyed its most successful season in the County competitions with a record number of entries. In the County competitions, M. Little won the Saga Over 55s Singles title for the second consecutive year. She also won the North of England Singles title defeating both Cumbria and Durham to progress to the regional winners' finals in Torquay. The 2-Bowl Singles title was won by J.

Graham, also the Norris Triples title with M. Shuttleworth and I. Fletcher. Moreover, they were runners-up in the NCWBA Triples competition, and they won the Fours title with B. Johnston. In addition to her competing in the EWBA National Finals held in Royal Leamington Spa, J. Graham was selected for umpiring duties. B. Johnston, B. Stafford and N. Rutherford were runners-up in the EWBA Benevolent Triples competition.

In 1988, PBC hosted the Northumberland Ladies' match against Yorkshire which was won by the visitors. In the County Ladies' Singles competitions, J. Graham won the 2-Bowl title for the second year running, and the 4-Bowl title in an all-Ponteland final against M. Shuttleworth. In the Rinks competition, B. Johnston, M. Shuttleworth, I. Fletcher and J. Graham were runners-up and participated in the EBWA National Finals held in Royal Leamington Spa. Six PBC members were selected to represent the County and attended the NCWBA President's tour of Lancashire.



**NCWBA Competitions won by PBC Ladies,1987**

(l - r) : Betty Johnston with the Fours Trophy, Maria Shuttleworth and Iris Fletcher with the Norris Triples Trophy and Joan Graham with the 2-Bowl Singles Trophy

In 1989, PBC hosted the County Ladies' "B" match against Durham. In the County Ladies' competitions, M. Shuttleworth won the 4-Bowl Singles title but lost, unfortunately, to the eventual Derbyshire winner in the National Finals held in Royal Leamington Spa. Also, T. Wright was the runner-up in The Saga 4-Bowl Singles competition. Six PBC members were selected to represent the County.

In 1990, M. Shuttleworth won the County Ladies' 4-Bowl Singles title and the Triples title with I. Fletcher and J. Graham. Also, M. Shuttleworth and J. Graham were the runners-up in the Pairs competition, . It is worth noting that in the past thirty years M. Shuttleworth is one of only three ladies to have represented the County in three competitions in the same year. In the other competitions, T. Wright, E. Newton and N. Rutherford won the Norris Triples title. Six PBC members were selected to represent the County, and four were invited to attend the NCWBA President's tour.

In 1991, PBC hosted the Area Final of the National Mother & Daughter Pairs competition between Cumbria and Durham. PBC also hosted the County Ladies' "B"

match against Cumbria. Four PBC members were selected to represent the County.

In 1992, when B. Johnston was President of the NCWBA, PBC hosted the County Ladies' competition finals, the County Ladies' "B" match against Durham which was played throughout in heavy rain, and the County Ladies' "A" v. "B" match. In the County Ladies' competitions, T. Wright, M. Shuttleworth and J. Graham won the Benevolent Triples title and went on to win the EWBA National competition. M. and R.I. Shuttleworth won the Mixed Pairs title and also the Mixed Fours title with L. and P. Telfer. In the North-Eastern Three-Counties Mixed Pairs competition, M. and R.I. Shuttleworth reached the semi-finals. Further to these results, members of the Ladies' Section appeared in five other semi-finals. Several PBC members were invited to attend the World Bowls tournament in Ayr with the NCWBA President, B. Johnston.

In 1993, T. Wright, N. Rutherford, M. Shuttleworth and J. Graham won the County Ladies' Rinks title. In The Saga Over 55s Pairs competition, the runners-up were E. French and L. Telfer. Six PBC members were selected to represent the County.



Middle Row : Joan Graham (6th from left) and Maria Shuttleworth (7th)  
Front Row : Betty Johnston (3rd from left) and Iris Fletcher (6th)  
President Janet Brodie (IOGT B.C.)

#### Northumberland CWBA Team v. Yorkshire CWBA, 1991

In 1994, PBC hosted the County Ladies' Finals in which the 4-Bowl Singles title was won by M. Shuttleworth. Also, she was the winner of the Northern Region Sanatogen Over 55s Singles competition and was the runner-up in the National Finals played at Wellingborough, Northants.

In 1995, PBC hosted the Northumberland Ladies' match against Durham. The Norris Triples title was won by M. Shuttleworth, T. Wright and M.E.H. Nesbit. In the Over 55s Pairs competition L. Telfer and E. French were the runners-up.

In 1996, PBC hosted the Northern Counties Ladies' match against Yorkshire. In the County Ladies' competitions, T. Wright won the 2-Bowl "Champion of Champions" title. The Triples title was won by M. Shuttleworth, L. Telfer and T. Wright. In the 2-Bowl Singles competition, M. Shuttleworth was the runner-up. PBC entered a new Travelsphere Top Ten County competition and were runners-up to Summerhill B.C.

In the 1996/1997 All-England Women's Indoor Championships, the Over 50s 2-Bowl Triples title was won by M. Shuttleworth, N. Carroll and J. Allison, both from Concordia IBC, Cramlington.

In 1997, PBC hosted the Cumbria Ladies' match against Durham for the Double Rink John's Trophy. In the County Ladies' competitions, J. Nichol won the 2-Bowl Singles title. R. Edwards, D.A. Johnson and I. Fletcher were the runners-up in the Norris Triples. Also, nine PBC members were selected to represent the County.

In 1998, PBC hosted the County match against Cumbria, and the Double Rink John's Trophy match between Cumbria and Durham. L. Telfer won the all-Ponteland final of the County Ladies' 4-Bowl Singles competition against M. Shuttleworth and subsequently with M. Shuttleworth, won the Pairs competition. PBC won the NCWBA Travelsphere Top Ten competition defeating Blyth Park in the final, and represented the County at York.

During N. Rutherford's County Presidential year in 1999, PBC hosted the following matches : Northern Counties Ladies' v. Durham Ladies', NCWBA Finals Day, EWBA President's team v. NCWBA, both Norris and Benevolent Triples semi-finals and finals and NCWBA v. Northampton Tourists. In the County competitions, M. Shuttleworth won the Ladies' 2-Bowl Singles title and the Norris Triples title was won by D.A. McDonnell, I. Fletcher and M.E.H. Nesbit.

In 2000, PBC hosted the County Ladies' match against Lancashire. In the County Ladies' competitions, M.E.H. Nesbit won the 4-Bowl Singles title and the Over 55s Singles title was won by M. Shuttleworth. Also, eight PBC members were selected to represent the County.

In 2001, M. Shuttleworth won the County Ladies' 4-Bowl title, and was the first Ponteland lady to win the 4-Bowl "Champion of Champions" Singles title. Also, the NCWBA and the Northern Region Over 55s competitions were both won by L. Telfer and E. French, and they represented the region at the Golden Charter National Finals in Coventry.



**Winners of the EWBA Benevolent Triples Competition, 1992**

(l - r) : Maria Shuttleworth, Joan Graham and Thelma Wright.

In 2002, the County Ladies' Triples title was won by D.A. McDonnell, J. Nichol and M.E.H. Nesbit.

In 2003, J. Nichol and L. Telfer were the runners-up in the County Ladies' Pairs competition and B. Johnston, J. Nixon and M. Richardson were the runners-up in the Triples competition.



**Winner of the 1994 NCWBA 4-Bowl Singles Competition,  
Maria Shuttleworth with President May Fairs (Willington Quay B.C.),**



**Winners of the 1996 NCWBA Triples Competition  
(l - r) : Maria Shuttleworth, Lorna Telfer and Thelma Wright**



**Winners of the 1996/7 All-England Women's Indoor Over 50s  
2-Bowl Triples Competition**

**(l - r) : Maria Shuttleworth, N. Carroll and J. Allison (Concordia IBC)**



**Winner of the 2000 NCWBA 4-Bowl Singles Competition,**

**Betty Nesbit, with President Kathy Bruce (Summerhill B.C.)**

**In 2004, PBC entertained the Norfolk County Ladies' Tourists. In the County competitions, D.A. McDonnell, J. Nichol, L. Telfer and M.E.H. Nesbit won the Rinks title. Also, M.E.H. Nesbit and J. Nichol won the Over 55s Pairs title and travelled to Yorkshire**

to play Lincolnshire in a regional round of the competition. Four PBC members were selected to represent the County and three members were invited to attend the NCWBA President's tour to Royal Troon.

In 2005, D.A. McDonnell, J. Nichol, L. Telfer and M.E.H. Nesbit again won the County Ladies' Rinks title, and J. Nichol won the County Ladies' 2-Bowl "Champion of Champions" title. Four PBC members were selected to represent the County.

In 2006, PBC hosted the semi-finals of the NCWBA Pairs competition. The event was somewhat overshadowed, following an incident with a member of the Men's Section, over the staging of the competition in the morning which was not shown in the 2006 Fixtures list. Apparently, a notice had been posted in the Clubhouse but was unseen by some members. Arising from the incident, the Chairman sent a letter of apology to the President of the NCWBA. The matter was considered closed when the Ladies' President received a letter of apology from the member concerned. PBC were runners-up to Benfield in the NCWBA Travelsphere Top Ten competition. Two PBC members were selected to represent the County.

In 2007, E. French & D. Walwyn-James won the County Ladies' Pairs title and one PBC member was selected to represent the County.

In 2008, PBC hosted the Northumberland Ladies' fixture against Cumbria and the semi-finals for the four major BN competitions. PBC won the Travelsphere Top Ten competition. Four PBC members were selected to represent the County.

In 2009, PBC hosted the Northumberland Ladies' fixture against Yorkshire and the County Pairs semi-finals. E. Emmerson won the County Ladies' 2-Bowl "Champion of Champions" title. M. Catchpole was runner-up in the County 4-Bowl "Champion of Champions" competition. D.A. McDonnell, M. Cowan, L.Telfer and J. Nichol were runners-up in the County Rinks competition. PBC were runners-up in the Double Rinks competition. Four PBC members were selected to represent the County.



**Travelsphere Top Ten Trophy Winners, 2008**

(l - r) : E. Emmerson, D.A. McDonnell, J. Nixon, E. French, M. Cowan, J. Nichol, M. Catchpole, L. Telfer, N. Caldwell, D. Walwyn-James and M.E.H. Nesbit

In 2010, PBC hosted eight fixtures during D.A. McDonnell's year as County President. Northumberland Ladies' won the Stella Logan match against Lancashire by a single shot, 121-120 but lost the Northern Trophy match against Yorkshire by 25 shots, 131-106. The other fixtures included the BN Finals, both Norris and Benevolent Triples semi-finals and finals, BN 2-Bowl and 4-Bowl "Champion of Champions" semi-finals

and finals and lastly, the BN Ladies' fixture won by BN Men. During the year, PBC won the BN Top Club Trophy by narrowly defeating Alnwick in the final. M. Cowan won an all - Ponteland BN Ladies' 4-Bowl Singles Final against the runner-up, E. Emmerson. The BN Triples competition was won by M. Robinson, P. Varley and L. Telfer. M. Cowan was runner-up in the 4-Bowl "Champion of Champions" competition. The North East Ladies' League Pairs competition was won by M. Cowan and L. Telfer. Three PBC members were selected to represent the County.



**BN Top Club Trophy Winners, 2010**

**Back Row (l - r) : P. Varley, J. Nichol, J. Nixon, E. Emmerson, M. Cowan  
Front Row (l - r) : M.E.H. Nesbit, D.A. McDonnell, M. Catchpole, L. Telfer,  
D. Walwyn-James and A. Brennan**



**Northumberland v. Lancashire in Stella Logan Competition, May 2010**



In 2011, PBC hosted a Northern Trophy match against Yorkshire, the visitors winning by 25 shots, 131-106 (coincidentally, as in 2010). PBC also hosted the semi-finals for the four major BN competitions. D.A. McDonnell and N. Craig (Burradon B.C.) won the Northumberland area Over 55s National Pairs competition. They participated in the National Finals held in Royal Leamington Spa along with M. Cowan the winner of the BN 4-Bowl Singles competition and E. Emmerson the runner-up. Four PBC members were selected to represent the County.



**Winner of the 2010 BN 4-Bowl Singles Competition,  
Margaret Cowan, with Di McDonnell (President)**



**Winners of the 2010 BN Triples Competition**

**(l - r) : Mary Robinson, Lorna Telfer and Pam Varley with Di McDonnell (President)**

In 2012, PBC hosted a Northern Trophy fixture against Durham, the visitors winning by 19 shots, 122-103. In the Northern Trophy match against Cumbria the visitors won by two shots, 108-106. PBC also hosted the BN 2-Bowl and 4-Bowl "Champion of Champions" competitions. The Benevolent Triples title was won by A. Rutter, E. Emmerson and M. Cowan. Four PBC members were selected to represent the County.



**Winners of the 2011 Northumberland Area Over 55s National Pairs' Competition, at the National Finals, Royal Leamington Spa.**

(l - r) : Norma Craig (Burradon B.C.) and Di McDonnell

In 2013, PBC hosted the Stella Logan fixture BN v. Durham and the County 2-Bowl "Champion of Champions" competition which was won by M. Cowan. PBC won the BN Top Club Trophy by defeating Hexham Elvaston in the final at Benfield B.C. by 12 shots, 43-31, and also the NEL League Pairs competition with A. Rutter and E. Emmerson. E. Emmerson was runner-up in the 4-Bowl "Champion of Champions" competition. Four PBC members were selected to represent the County.

In 2014, PBC hosted both the Stella Logan fixture BN v. Yorkshire and Northern Counties fixture BN v. Cumbria. The inaugural County Mixed Pairs competition was won by J. Nixon and D.W. Morrison. PBC ladies also performed well in various County competitions finishing as runners-up three competitions viz. the Benevolent Trophy, the Norris Triples and the NEL Triples.

In 2015, PBC hosted the County fixture and the 4-Bowl "Champion of Champions" competition. P. Varley won the 2-Bowl "Champion of Champions" competition. S.A. Storey, M. Robinson and G. Stapylton had the satisfaction of winning the Benevolent Triples having been the runners-up in 2014. Also, PBC were runners-up to Burradon in the County Double Rinks event.

In 2016, PBC hosted the County fixture BN v. Lancashire. The Benevolent Triples competition was won by M. Cowan, E. Emmerson and A. Rutter. The Norris Trophy was won by G. Stapylton, D. Taylor and S.A. Storey. Eight PBC members were

selected for the Northern Counties and Stella Logan fixtures. This is the highest number since 2000 and 1997 when 8 and 9 members respectively represented the County.

In 2017, PBC hosted the Stella Logan fixture BN v. Durham, the visitors winning by 33 shots, 119- 86. A. Brennan, S.A. Storey, M. Turner and G. Stapylton were runners-up in the final of the County Rinks competition. They were taken to an extra end losing by one shot to a talented Benfield Club who won five of the six County competitions in 2017. Seven PBC members were selected to represent the County.

In 2018, PBC hosted the Stella Logan fixture BN v. Yorkshire. PBC were successful in winning the County Over 55s final against Burradon and represented Northumberland at the National Finals in Royal Leamington Spa. PBC were runners-up to Benfield in the County Double Rinks competition. Five PBC members were selected to represent the County.

In 2019, PBC hosted the Northern Counties fixture BN v. Durham, the visitors winning by 120 shots to 96. PBC also hosted two rounds of the 2-Bowl "Champion of Champions" competition. Seven PBC members were selected to represent the County.

In 2022, PBC hosted the Stella Logan fixture BN v. Yorkshire which was won by the visitors. The Club also hosted the Ladies' County President's Day with Allison Storey the Lady President. It is arranged as a fun bowling event which raised over £900 for her chosen charity, Alzheimer's Newcastle UK.. A. Pearson, R. Twizzel & J. Galbraith won the BN Ladies' Benevolent Triples Competition. Five PBC members were selected to represent the County.

In 2023, PBC hosted both the 2-Bowl and 4-Bowl "Champion of Champions" finals. E.J. Ramsay, A. Shipley and A. Pearson won the NELBL Triples Competition. Four PBC members were selected to represent the County.



**Winners of the BN Double Rinks Competition, 2013**  
(l - r) : P. Varley, D.A. McDonnell, E. Emmerson, A. Rutter, J. Nichol, J. Nixon,  
M. Catchpole, L. Telfer, M. Turner, G. Stapylton and M. Cowan



**Winner of BN 2-Bowl "Champion of Champions" competition, 2015  
Pam Varley presented with trophy  
by Mrs Rae Brown (Alnwick B.C.)**



**Winners of the North East League  
Pairs' Competition, 2016  
Irene Eden and Cathy Donachey**



**Winners of the BN Ladies' Benovolent Triples Competition, 2015  
(l-r) : Gloria Stapyhton, Mary Robinson and Allison Storey  
with President Mary McNally (Amble B.C.)**



**Winners of the BN Ladies' Over 55s Competition, 2018**  
**(l-r) : Gloria Stapylton, Allison Storey, Margaret Turner and Jean Barras**



**Runners-Up in the BN Double Rinks Competition, 2018**  
**(l - r) : A. Brennan, G. Stapylton, M. Turner, P. Varley, M. Cowan,  
S.A. Storey, J. Nixon, J. Barras and O. Driver**



**Northumberland v. Lancashire in Stella Logan Competition, June 2022**



**Winners of the BN Senior Ladies' Fours, 2022**  
**(l - r) : M.Turner, A. Brennan, M. Cowan, and S.A. Storey with**  
**BN President Vivienne Shepherd (Alnwick B.C.)**



**The Ladies' County President's Day, 3rd July, 2022**



**Winners of the NELBL Triples Competition, 2023  
(l-r): E.J. Ramsay, A. Shipley and A. Pearson**

# 6

## Representative Honours

### 6.1 Men's Section

In chronological order, the following PBC members represented the NCBA League against winners' of the Clegg Cup, Knight Cup and Edwardson Cup competitions :

Member	Year	Clegg Cup	Knight Cup	Edwardson Cup
W. Wilson	1952	Wallsend	-	-
M. Johnstone		-	Brighton	-
E. Forster		-	Brighton	-
E. Forster	1953	Collingwood	-	-
T. Fatkin		Collingwood	-	-
M. Johnstone	1954	Collingwood	-	-
J. Ions		-	Willington Quay	-
E. Hopkinson	1955	-	Brighton	-
R.F. Pascoe		Whitley & Monkseaton	-	-
J. Oliver		-	-	Willington Quay
E. Hopkinson	1956	-	Walker Park	-
R.F. Pascoe		North Shields W. E.	-	-
A. Young	1957	-	Benwell Hodgkin	-
A. Attwater		Walker Park	-	-
J. Carr	1958	Walker Park	-	-
T. McPhee		-	Rockcliffe	-
E. Forster	1959	Wallsend Borough	-	-
W. Weightman		-	Nuns Moor	-
J. Oliver		-	-	North Shields W.E.
T.W. Cuthbert	1960	Rockcliffe	-	-
J. Oliver		-	-	North Shields W.E.
J. Loughton	1962	-	Willington Quay	-
J. Oliver		-	-	Brighton
W. Wilson	1965	-	North Shields W.E.	-
W.S. Douglas		Willington Quay	-	-
R. F. Pascoe	1966	-	-	North Shields W.E.
W. Wilson	1967	-	Walker Park	-
R.F. Pascoe	1968	-	-	Whitley & Monkseaton
J. Oliver		-	-	Whitley & Monkseaton



Also, in 1959 and 1960, both J. Oliver & R.F. Pascoe represented PBC in matches against the NCBA President's team. However, due to an increasing number of competitive matches, these very popular League fixtures were discontinued.

In chronological order, the following six PBC members represented the County in the Northern Counties Armstrong Trophy competition. The number of appearances is shown in parenthesis :

B.D.W. Wright, 1979 (1), M.A. Bennett, 1983 (10), R.I. Shuttleworth, 1994 (1), K.D. Wood, 1994 (4), W.R. Liddle, 1996 (51) and R.J. Varley, 2006 (16).

Again in chronological order, the following seven PBC members represented the County in the Alsop, Muras and Middleton Cup competitions :

J. Oliver, 1952 (73), R.F. Pascoe, 1956 (57) , T. McPhee, 1959 (67), T.W. Cuthbert, 1962 (89), M.A. Bennett, 1985 (90) has continued to represent the County with other Clubs upon leaving PBC in 1999. W.R. Liddle, 2005 (3 ) and R.J. Varley, 2009 (1).

In 1995, M.A. Bennett and K.D. Wood represented England when winning the Pairs' title at the British Isles Championships, held in Llanelli.

In 1997, M.A. Bennett represented England in the Series of Home Internationals and remained in the England squad in 1998.

## **6.2 Ladies' Section**

In chronological order, the following twenty-one PBC members have represented the County. The year shown in parenthesis indicates their first appearance whilst at Ponteland :

J. Graham (1983), I. Fletcher (1987), N. Rutherford (1987), B. Johnston (1988), M. Little (1988), M. Shuttleworth (1988), T. Wright (1990), E. Newton (1991), J. Nichol (1992), M.E.H. Nesbit (1995), L. Telfer (2001), E. Emmerson (2006), M. Cowan (2008), D.A. McDonnell (2009), G. Stapylton (2012), M. Turner (2013), A. Brennan (2015), P. Haylock (2015), R. Johnson (2015), S.A. Storey (2015), E. Cowings (2017), L. Marsh (2019) and A. Pearson (2021).

## The Bowling Green

On matters relating to the bowling green, the General Committee reported in February 1936, that PMH Committee had little or no money to spend on its maintenance. Immediate action was sought to treat the prevalent moss and provide a top dressing *'but not to put the same manure on as last year as it removed the polish from the bowls.'* Having written, and received no acknowledgement from PMH Committee, the General Committee decided at the Club's expense, to seek expert advice on ways to improve the condition of the green. In 1944, the deteriorating condition of the bowling green, mainly due to moss and clover, was again of great concern. The main problem, however, was the difficulty experienced by PMH Committee in finding a suitable greenkeeper. For a time, a local farm-worker employed on a thresher was the only person available. Not quite the qualification one would have thought for being a greenkeeper. Notwithstanding, the Club usually presented the greenkeeper with a £2. 2s. 0d gratuity at the end of each season.

In 1945, PMH Committee authorized the Secretary to contact the Miners Welfare Organization and Messrs Finney's, Newcastle for their advice in treating the green. In 1946, it was reported that the bowling green had received its pre-season treatment by forking and distributing 3 cwt of lawn sand, fertilizer, and *' the usual covering of sand '*. The deleterious effects of the continuous application of sand as a top-dressing, over the years, became apparent in 1976.

In 1947, permission was sought from PMH Committee to allow improvements around the bowling green so as to conform to International Bowling Board (IBB) standards. The work involved the provision of a 34ft. stretch of turf, 3ft. wide, alongside the Pavilion, and the perimeter of the green to be surrounded by a low wood batten fence or have its bank-sides heightened. The wood batten fence was erected, being the cheapest option. Unfortunately, in 1949, the turf required re-laying.

In 1951, the green was reported to be playing very well, and the Club offered PMH Committee £50 plus the proceeds from casual fees towards its maintenance costs. An annual rental payment of £50 was made until 1962. The greenkeeper's end-of-season gratuity was increased to £5 in 1952.

In June 1952, the General Committee decided to purchase a motor lawn mower, and were grateful for the offer of 50% of the purchase price from PMH Committee. Also, in 1952, a manually operated deep turf piercer was purchased at a cost of £35.16s. 0d. At that time, the lack of proper maintenance in rolling and cutting of the bowling green, and the absence of rink rotation, had caused problems. Also, in the late 1950s, much criticism was levelled at certain players and visitors who were not delivering their bowls correctly and seriously damaging the green. In view of this situation, fining the offending players 1s. 0d was contemplated.

In 1959, the first instance of vandalism of the bowling green was reported. Two years later, reservations were expressed about payment of the end-of-season gratuity to the greenkeeper as the condition of the bowling green and its surrounds had deteriorated significantly. In fact, it was necessary to draw to the attention of PMH Committee in February 1962 that a supply of sharp sand dressing was still lying beside the green from the previous October. At the 1962 AGM members considered the bowling green was in need of more rolling and rotation of the rinks than hitherto.

In 1964, PMH Committee provided much needed seating around the green.

At a GPC meeting, held in January 1967, it was reported ' *a second invasion of the bowling green had been made by a pony.*' Twenty square yards of replacement Cumberland turf had been laid and the green had been spiked, rolled, and top dressed. The following year, the condition of the bowling green again gave cause for concern, with bare patches in evidence.

In 1969, it was considered necessary to seek information from the Sports Turf Research Station, Bingley, Yorkshire on the upkeep and maintenance of the bowling green. However, local advice was available from the Kirkley Hall Institute, and following an analysis of core samples taken from the green, a written report was prepared by Mr R. McParlin of their Horticultural Centre on the condition of the bowling green. The recommendations, regarding necessary treatment of the green were accepted, and the greenkeeper was offered and accepted a payment of £100 p.a. for normal maintenance work.

In January 1970, following consultation with Club Officers PMH Committee readily agreed to allow the Club to take full responsibility for the future maintenance of the bowling green. The Club, however, would not be responsible for the surrounding area. A nominal annual rent of £1 1s. 0d was set, and PMH Committee agreed to provide a maximum grant of £80, towards the cost of implementing the recommendations made by Kirkley Hall Institute, to improve the condition of the bowling green.

In August 1970, it became necessary to close three rinks in order to carry out urgent treatment, comprised of spiking and applying a mix of sand, granulated peat, and a special lawn dressing, followed by re-seeding with a first class lawn seed. With the remaining three rinks in need of similar treatment, it was considered it would be at least three years before the green would be in good order. Happily, in spite of these difficulties, the domestic competitions were completed. Considerable difficulty was again experienced in the recruitment and retention of a suitable Green-. Later on, however, the sole efforts of a volunteer greenkeeper ended happily with the introduction of a Green's Committee and the appointment of a sensibly remunerated greenkeeper. He was responsible for the mowing and application of spring and autumn dressings, and re-seeding at the end of the season.

The pros and cons of rolling the green has been a source of debate over the years, and the last recorded rolling took place during the autumn in 1972. In the spring of 1973, the bowling green required treatment to eradicate the prevalent moss, and a machine from the Sports Centre was used to remove the dead grass. In 1974, an autumn dressing of peat and bone meal was carried out.

The non-professional maintenance of the green in preceding years, with the continued application of sand as a top dressing, led to the disastrous state of the green in the extremely hot summer in 1976. An unusual incident occurred during the Gosforth Bowlers Touring Club visit to South Devon that year when it was seen that some of the greens were covered with ladybirds. Quite a bowling experience in the extreme heat. On returning from the tour the Secretary discovered a stretch of turf, more than 3ft. wide, had lifted off the surface of the green, and was curled up alongside the entire southern edge of the bowling green. The eastern edge also was affected. The greenkeeper, J.A. Main, also had been on tour and, in his absence, apparently none of the members at the Club had watered the green in an attempt to limit the damage.

On inspecting the green a quotation of £4,860 + VAT was received from a local contractor for re-turfing the whole green. To renew the green entirely, and conform to the IBB recommendations for drainage and its surrounds, the cost would rise to £15,000. This, clearly, the Club could not afford. Subsequently, an examination of the green, by taking 4in. deep core specimens, revealed a 1in. layer of dead grass/thatch with little or no grass roots in the sub-layers of compacted fine sand. Altogether, some

35 per cent of the bowling green was affected, including small stretches along its western and eastern sides. Necessarily, 640 square yards of exhausted turf, and layers of compacted sand to a depth of 2 in., were removed. The underlying 4in. layer of sand had been laid over a 2in. layer of clinker above the clay bed. The top surface of sand was deeply forked and 30 tons of top soil mixed with quarry sand was added. Silloth turf was laid on the re-vitalized surface. In 1977, following the Secretary's letter to Lord Ridley seeking possible grant-aid towards the cost of re-turfing parts of the green, arrangements were made for a visit by the Head Groundsman from Northumberland County Council. In connection with this work Mr David Batten, Secretary of the Northumberland Playing Fields Association (NPFA), invited a member of the Green's Committee to attend a 1-day course at the local agricultural college.

• TURF & SUB-SOIL LAYERS IN 1976

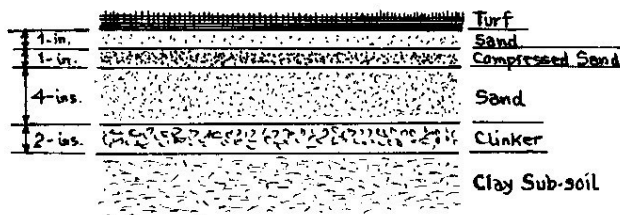

• TURF RENEWAL FOLLOWING 1976 SUMMER DROUGHT : 640 sq.yards.

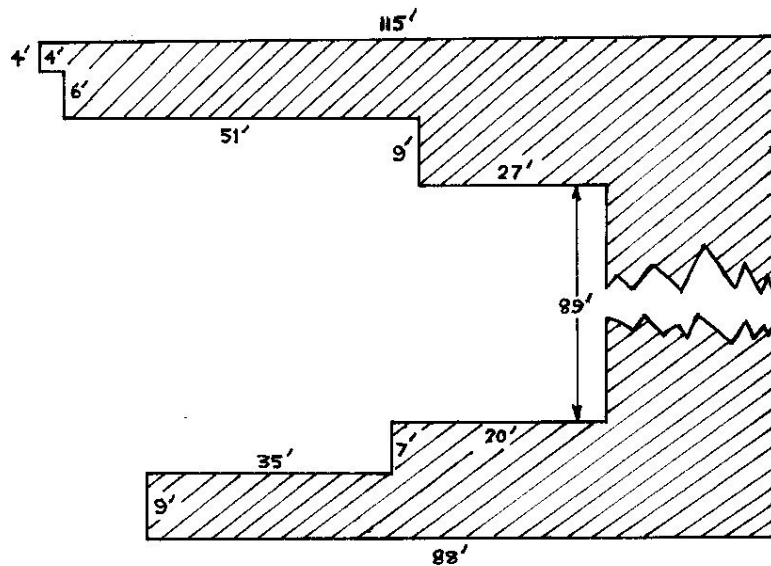

*B. D. Wright*  
1976

Ponteland Bowling Green Specification and Turf Renewal, 1976.

Further improvement took place at the green when the posts and surrounding low wood fence battens around the green were removed. They were in very poor condition and, at that time, the bowling green surrounds did not conform to IBB standards. During the closed season in 1977, the Secretary raised the green surrounds

on the eastern and northern sides of the green and turfed the bank-sides. During the closed season in 1978, the Secretary, with the able assistance of both T. McPhee and W. Middlemiss, raised the remaining green surrounds and turfing of the bank-sides was completed.

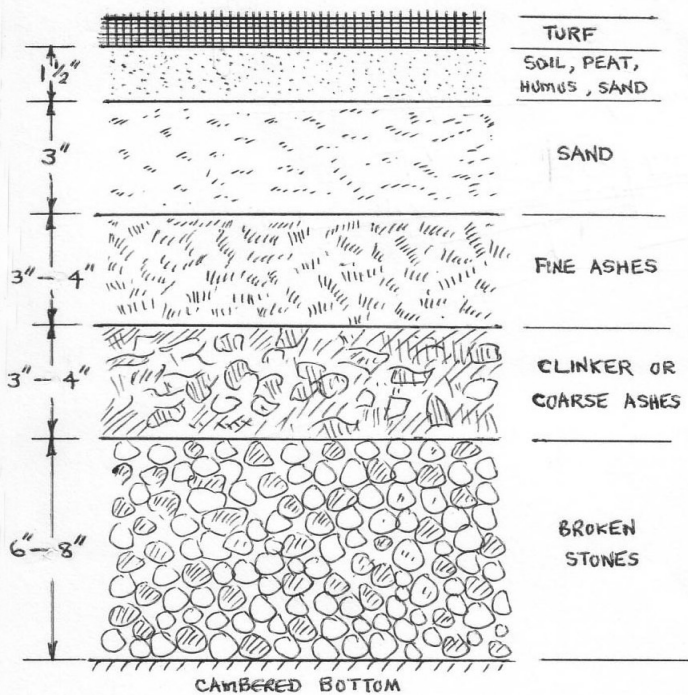
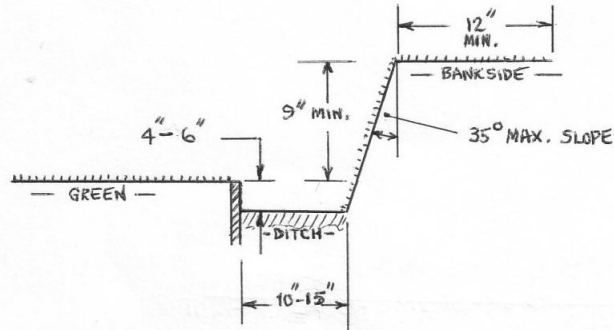

TURF LAID IN 12" SQUARES

**Specification for Bowling Green  
Approved By International Bowling Board, 1949.**



**Construction of the bank-sides by the Secretary in October 1977 and completed in April 1979.**

In 1978, at a meeting of PMH Management Committee, the Secretary had requested permission to erect an 8-ft. high wire fence in order to secure the bowling green premises from future attacks of vandalism. Subject to obtaining the required planning permission, a 25% grant for this work would be made available.

The efforts of the volunteer labour force of Club members after several months' work were rewarded when home fixtures were resumed in 1978, albeit on shortened rinks. In this connection, the Secretary was indebted to P. Manson for his attendance at the green on Wednesdays to cut the bank-sides and verges, and for providing a hand mower.

In 1980, the GPC decided to seek professional assistance in the management of the bowling green. The initial work required was estimated at £450. Mr L. Wilson from Low Fell, who worked regularly on other greens, was contracted to improve the condition of the green and improve its levels. He continued working at PBC until his retirement in March 2004.

In 1983, a new mower with spiker and comb was purchased. Members again voiced their concern at the state of the green, as there were numerous bare patches, and a considerable presence of moss. Also, the green had suffered much damage, due to some members and opposing players not delivering their bowls correctly. A notice to this effect was displayed prominently in the Pavilion. In order to keep a watching brief on the state of the green T.W. Cuthbert accepted the new appointment of Green Ranger and liaised with L. Wilson.

In 1985, the cost of professional green maintenance, the provision of new entrance gates, a water-sprinkler system and new score-board exceeded £3,300.

In February 1986, two members attended a seminar, organised by the NCBA, on green maintenance at the Scotch Corner Hotel. A barrel roller was purchased on the recommendation of the EBA's / Greens Maintenance Advisory Scheme.

In 1987, the cost of green maintenance and equipment exceeded £1,600.

In 1988, the Club's professional green adviser, L. Wilson, considered the present system of rink rotation was now inadequate. It had been introduced when the membership was 60 as against the present combined membership of 160. By the end of the season the green was in a very poor state, particularly on the rink ends. Changes were necessary in the management of the green due to the increasing number of league and friendly fixtures arranged for the combined membership. Contrary to greenkeeping procedure, L. Wilson would not recommend rolling of the green as part of the maintenance programme and advised against the use of matting.

Early in 1991, the GPC reported that some irresponsible young persons had damaged the green. In order to reduce green maintenance costs, the turfed bank-sides were replaced with boarding covered with synthetic turf.

In 1992, the condition of the green was again not in a satisfactory state, despite the professional attention of L. Wilson and the Green's Committee. Following a meeting of the GPC, J. S. Duff took soil samples for analysis, and D. Boland surveyed the green identifying its unevenness. Work to improve the drainage of the green was carried out in 1993, at a cost of £2,100. Some levelling of the green was carried out, and a new machine purchased at a cost of approximately £2,500. Also, borders containing roses, some of which were gifts from three lady members, and bedding plants were set out around the green.

At the close of the 1994 season, the green was severely damaged by a marauding bullock, which had escaped from the local Auction Mart. Remedial work was carried out in restoring levels at the south-west corner of the green, at a cost of £200. In 1995, routine maintenance by L. Wilson costing £1,600, saw a big improvement in the condition of the green and the Club received many compliments from both players and visitors.

In 1996, the drainage was improved along the east side of the green. Also, two of the ditches were renovated and paving laid along the bank-sides at a total cost of £3,100.

In 1997, a new automatic watering system was installed at a cost of £6,500 which was partly financed by the EBA, with a repayable loan of £2,000 plus interest. Unforeseen problems, due to the sprinkler vents of the watering system being too near the Pavilion, were resolved by L. Wilson at a further cost of £2,000. The work entailed the west side of the green being moved 2ft. away from the Pavilion, and extended by 2ft. on the east side.

In 1998, approximately £4,000 was spent on green maintenance which was carried out by L. Wilson. This included the completion of work on the remaining two ditches and paving the bank-sides. In 1999, it was reported that the green had been damaged by some youths attending a party held in PMH. The question of security around the Club premises had first been discussed with the PMH Committee by the Men's Secretary, B.D.W. Wright, in 1978 but without resolution.

Early in 2001, L. Wilson carried out some levelling of the green following heavy winter rains leading to surface water in some areas. With the arrival of spring the green was subject to an invasion of rabbits and it was necessary to erect a wire fence alongside the hedge on the south side of the green. At the end of the bowling season the green was tined and a top dressing applied. The work carried out by L. Wilson in 2001 cost just over £1,600 and again over £1,700 in 2002. It was agreed that the green should be closed mid-September in future years to permit necessary re-seeding and other maintenance work on the green. An unexpected incident occurred at the end of the 2001 bowling season when a helicopter landed on the green to deal with a medical emergency. Fortunately, the surface of the green suffered minimal damage.

In 2002, an expenditure of £2,756 was incurred on green maintenance and £121 on machinery equipment. Routine maintenance work was carried out and Cowell's Garden Centre agreed to sponsor the display of bedding plants around the surrounds.

In 2003, a total expenditure of £4,650 was incurred on green maintenance and the purchase of other equipment. Dobbies Garden Centre kindly agreed to sponsor the display of bedding plants at the green.

In March 2004, L. Wilson retired from all activities at the green. At the start of the season, a great deal of moss was found on the green. The problem was soon rectified with the recruitment of Colin Moore working under the guidance of R. Stafford. He was a former Council greenkeeper who also looked after the green at Gosforth Garden Village B.C. In 2004, a total expenditure of £9,860 was incurred on green maintenance. This included £4,800 on purchasing the Dennis an improved grass-cutting machine and a Walkman, at a cost of £350, to spray fungicide, liquid moss killer and fertilizer. Dobbies Garden Centre again agreed to sponsor the display of bedding plants at the green. In 2005, R. Stafford provided 200 home-grown bedding plants at no cost to the Club. His gesture in providing a splendid floral display was much appreciated by the members and visitors.

Security measures around the Club precincts required further consideration following the act of vandalism to the green in December 2005. On this occasion the police were informed of the incident. In the past, discussions on security had taken place with PMH Committee but without any resolution of the problem.

Early in 2006, the green was scarified, top dressed with moss killer and fertilizer. A brush attachment for the Dennis machine was purchased at a cost of £495. Recent health problems of both the Green Ranger and his assistant prevented the end-of-season activities of scarifying, moss-kill, fertilizing and top dressing of the green until early spring. This delay resulted in the green not being up to the standard of recent years but had vastly improved by the end of the season. The green was hollow tined followed by a top dressing immediately after Closing Day. R. Stafford who had been the Green Ranger since November 1999, agreed to carry on with these duties until the AGM in October 2007. This would enable the greenkeeper to gain additional experience with the sophisticated Dennis FT machine and, with the assistance of the Green's Committee, carry out other routine maintenance activities at the green. In view of the Green Ranger's health problems the offer of assistance by M.L. Brennan to act as the deputy Green Ranger was appreciated. Unfortunately, he tendered his resignation at the end of the season due to the lack of co-operation of some members who were continually damaging the green when delivering their bowls. The assistance given to the Green Ranger around the surrounds of the green by W. Bell over the years was gratefully acknowledged. In 2006, R. Stafford again provided 200 home-grown bedding plants which again were much admired by the members and visitors during the season, and particularly by the rabbits in the borders near the equipment store!!! Rabbits were previously reported to be a nuisance early in 2001.

Early in 2007, L. Wilson was engaged to replace the wood boards supporting the edging around the green prior to it being re-seeded and top dressed. The new Sorrel roller cassette spiker, attached to the Dennis machine, was used for regular aeration and light scarifying of the green. The sharp sand used in the ditches was to be replaced with 300 rubber protector tiles costing £2,200 with a 10-year guarantee. The tiles were 24" long x 9" wide and portable for winter storage. A wooden container for storing grass cuttings was installed alongside the water tank. In 2007, an expenditure of £8,248 was incurred on green maintenance and £860 on machinery equipment.

It was reported in 2008 that rabbit droppings were a big problem on the green. Hollow tining and regular scarification had been carried out. Laying down of the ditch protection tiles was completed before Opening Day. Unfortunately, the green suffered a



great deal of damage during the very wet season mainly due to both members and visitors not delivering their bowls correctly. In mid-September 2008, substantial flooding occurred in Ponteland (and elsewhere) with the bowling green under water and over the bank-sides. An interesting feature of the photograph below is evidence of surface compaction. During early autumn, re-seeding and top dressing was carried out. Also, D.W. Kirk attended a Green Ranger's course in Wigton, Cumbria. In 2008, an expenditure of £7,794 was incurred on green maintenance and £468 on machinery equipment.

Early in 2009, judges from the "Northumbria In Bloom" competition provided advice on plants for the borders around the green. Following hollow tining and very wet weather which delayed spreading of a top dressing, the green gradually improved during the season until further wet conditions resulted in much damage to the green. One disadvantage of installing the black ditch tiles has been the need to replace some of them most mornings' following their removal by crows looking for grubs !!! The John English memorial garden bequest was used towards the creation of a rock garden. The work was undertaken by J. & Mrs E. Gatenby with the assistance of members who donated shrubs and assisted with the planting. Hollow tining was carried out shortly after closure of the green. In order to minimize damage to the playing surface following wet periods, six protector mats, size 8'x7', would be available for the 2010 season. As in previous years, R. Stafford provided home-grown bedding plants for the surrounds which were much admired by members and visitors during the season. In 2009, an expenditure of £5,388 was incurred on green maintenance and £556 on machinery equipment.



PBC green following severe flooding , 6<sup>th</sup> September, 2008.

Following heavy snowfall during the 2009/2010 winter, the dead patches on the green had recovered well when scarified and spiked weekly. Springtime, M. McDonnell provided valuable assistance with both his labour and equipment for installing the new ditch backboard around the green. When the season ended, a useful soil survey was performed. Also, re-turfing of a small area along the edge adjacent to PMH and raising of the green alongside the footpath was necessary. Some damage had occurred on the green due to vandalism. The efforts of the Green's Committee throughout the season and of other members who provided hanging baskets (M.L. Brennan) and bedding plants (R. Stafford) were well rewarded when it was announced that, at the first attempt, the Club and the Tennis Club had jointly been awarded a Silver Gilt Medal Certificate in

the “Northumbria In Bloom” competition. At the awards ceremony held in Eaglescliffe, Stockton-on-Tees, J.T. Harrison represented the Club, accompanied by his wife, Ann. In 2010, an expenditure of £5,086 was incurred on green maintenance and £439 on machinery equipment.

In 2011, the green had responded well to regular maintenance following a very early dry spell and continual wet conditions during the second half of the season. The ramps previously used for access to the green were replaced by steps with a handrail support. At a cost of £159, the frost-damaged garden shrubs were replaced. In August 2011, the Green Ranger, D.W. Kirk, tendered his resignation following unjustified criticism of him regarding the condition of the green which had been adversely affected by the previously severe winter weather. He agreed to provide a job-description of the work involved for his successor, W.R. Liddle who would, however, only be responsible for the bowling green. The Green’s Committee would undertake the remaining maintenance work around its surrounds. For the second year running, the Club and the Tennis Club were jointly awarded a Silver Gilt Medal Certificate in the annual “Northumbria In Bloom” competition. Thanks were due to the efforts of the Green’s Committee throughout the season and of other members who provided the hanging baskets (M.L. Brennan) and bedding plants (R. Stafford). Following closure of the green, raising of the turf edges, hollow tining and application of a top dressing was carried out. In 2011, an expenditure of £7,016 was incurred on green maintenance and £575 on machinery equipment.

In 2012, the unseasonable wet weather had caused moss problems requiring extra treatment. The Green Ranger’s assistant, Colin Moore, often found difficulty under these conditions in scarifying the green, grass-cutting and other routine work before 10 a.m. Under these unusual circumstances, the Green Ranger, W.R. Liddle, needed to be present to provide assistance. A new Dennis Machine with a 9-bladed cutter was purchased for £5,159. Prior to proceedings at the Prize Giving on Closing Day, there was a short presentation on the bowling green on behalf of the PTC. The Club and the Tennis Club jointly received a Gold Medal Certificate presented by Councillor, Joyce Butcher, in the annual “Northumbria In Bloom” competition. Again, thanks were due to the efforts of the Green’s Committee throughout the season and of other members who provided hanging baskets (M.L. Brennan) and a nice display of bedding plants (R. Stafford). In September 2012, J. and Mrs E. Gatenby represented the Club at the “Northumbria In Bloom” award ceremony held at Spennymoor, Durham. Shortly after Closing Day, the green was scarified in different directions and treated for moss. Later on, the ends of the rinks were over-seeded and any damaged areas. In 2012, an expenditure of £8,869 was incurred on green maintenance and £5,652 on machinery equipment.

In 2013, with the help of a working party of volunteers several tasks were completed in preparing the green for Opening Day. They include eradicating both moss and fungi, repairing crow damage, securing the rink edges and surrounds. At the end of the season the Green Ranger, W.R. Liddle, reported that the maintenance winter programme was well in hand with its progress displayed on the Clubhouse notice board. External expert advice had been sought and future materials will be sourced directly in order to manage maintenance costs. The new aerator proved to be a good investment being an integral part of the work on the green, it taking about two and a half hours to aerate the surface. Volunteers will be required during the winter to swish the green to restrict the spread of fusarium disease. Congratulations were extended to the Green’s Committee on the excellent state of the surrounds and the winning of two awards, jointly with the Tennis Club, viz. Gold Medal Certificates in the “It’s Your Neighbourhood” and “Northumbria In Bloom” competitions. In 2013, £5,96 was spent on green maintenance and £369 on machinery equipment, the total cost being 45% less than in 2012.

Early in 2014, although the green had been treated with both a moss killer and

fungicide it was not entirely moss-free. The watering system was re-commissioned and a working party of volunteers had completed necessary tasks in preparing the bowling green for Opening Day, viz. positioning bank-side rink-markers and numbers, replacing mats in the ditches, cleaning the bench seats and placing them around the green, re-painting the entrance gates and flagpole, also tidying up of the equipment shed. Regular end-of-season activities around the green involved the removal of bedding plants and general tidy-up of the surrounds, returning bench seats to store, hedge trimming. The Club and the Tennis Club were jointly awarded another Gold Medal Certificate by the judges of the annual "Northumbria In Bloom" competition. In 2014, an expenditure of £6,048 was incurred on green maintenance and £10,034 on machinery equipment. The total cost in 2014 being £9,750 more than in 2013.

In 2015, a new battery-controlled fertilizer/weed killer sprayer was purchased at a cost of £780 ensuring consistent and even application of materials. An expenditure of £4,177 was incurred on green maintenance and £1,489 on additional machinery equipment. The Treasurer on finding the total cost in 2015 somewhat £10,416 less than in 2014 could breathe a sigh of relief. Judges of the annual "Northumbria In Bloom" competition awarded jointly a Silver Gilt Medal Certificate to the Club and Tennis Club.

For some years now there has been a problem with the end rinks alongside PMH and the tennis courts. Although the condition of the playing surface is very good it has, to some extent, been mostly unplayable due to the green running down towards each ditch. A survey of the green was carried out by A. Barratt assisted by external professional advice. In order to bring the two end rinks up to the required playing standard the GPC decided to have the two edges of the green levelled at an estimated cost of £5,000. It involved lifting 1.5 m of turf along each side of the green, renewing the wood boards supporting the edges, levelling with Rootzone and relaying of turf. Work on the remaining two edges of the green to be carried out later.

In 2016, W.R. Liddle reported that the fusarium treatment was effective and spiking of the green had appeared to have successfully penetrated the very hard surface. The winter maintenance programme advised by Sheriff Amenities was adopted. To assist the Green Ranger a handyman was engaged for cutting and slitting the green also cleaning the bank-side ditches. In order to minimise damage to the green a new one-week rota system for 2017 was proposed by W.R. Liddle. In 2016, an expenditure of £10,986 was incurred on green maintenance due to professional labour costs. Once again, it is pleasing to record the combined efforts of volunteers in both the Club and the Tennis Club resulted in the joint award of a Gold Medal Certificate by the judges of the annual "Northumbria In Bloom" competition.

In 2017, there was evidence of fusarium on the edges of the green. The green had been cut and spiked every month during the previous winter months. The new system of rotation of the rinks during the season had proved very successful. Following consultation with Sheriff Amenities the Compost Tea Brewing Kit treatment was applied. A new 3-week rota system for playing on the green was drawn up by the Green Ranger, W.R. Liddle, to be adopted in 2018. It was decided by the GPC that the remaining two sides of the green viz. the one alongside the Clubhouse and the other furthest away from PMH, needed to be raised and the wood boards supporting the edges renewed. The edges were previously repaired in 1997/1998. Sports Turf Services was chosen for this work and was commenced during the closed season. In 2017, total green maintenance costs were £5,760. The combined efforts of the volunteers in both the Club and the Tennis Club again resulted in the joint award of a Gold Medal Certificate by the judges of the annual "Northumbria In Bloom" competition. A successful greens seminar sponsored by SYMBIO was held in the Clubhouse in November. Twenty-three persons attended the intensive accredited course for green rangers including members invited from golf and bowling clubs.

In 2018, work scheduled for the final two sides of the green was completed. Not having an elected Green Ranger this year, maintenance work on the green during the season was carried out by a handyman with a group of volunteers. A new 3-week rota, drawn up by W.R. Liddle, proved helpful in reducing damage to the playing surface. In 2018, total bowling green maintenance cost was £12,713 a significant increase due to professional labour costs. In the "Northumbria In Bloom" competition the Club and the Tennis Club were jointly awarded a Silver Gilt Medal Certificate. For his most generous gift of a replacement flagpole, the Committee expressed their thanks to Past President, A.O. Christie.

Following preparation of the winter programme for the green by W.R. Liddle, the post of Green Ranger, initially held by him from August 2011, became vacant with his resignation in October 2018. His efforts over the years with the help of volunteers in providing an excellent playing surface were much appreciated by members and visitors. Swishing of the green by volunteers on a daily basis to remove dew continued throughout the winter.

Before the Opening Day in April 2019 a working party repainted the bench seats and carried out a tidy-up of the surrounds. Previously, patches of fusarium appeared in the green and remedial action was taken during the spring including the application of a moss killer followed by verti-cutting of the green. Because, there is no publicly available fungicidal treatment that can be applied to the recent spread of fungal disease Anthracnose found in the green. The main causes of this disease are turf stress due to soil compaction, areas of high wear, very low turf-cutting heights and drought effects. A new summer programme of maintenance was arranged. In the absence of a Green Ranger several members shared the role during the summer period. A rota was drawn up with members taking responsibility for two-week periods helped by a nominated replacement. The volunteers were reminded that the Green Ranger is responsible for deciding the green is fit for play. Team Captains will decide if the green is safe to play on. Unlike 2018, periods of heavy rain in 2019 caused cancellation of several fixtures and some domestic competitions. In 2019, an expenditure of £6,282 was incurred on maintenance of the green and £1,389 on machinery & equipment.

In view of the Coronavirus (Covid-19) in 2020, all league matches and friendly fixtures were cancelled. However, some bowling was allowed in June until August but with limited numbers present on the green. Unfortunately, increasing lockdown problems later on in September enforced closure of the Clubhouse and its surrounds. The green, however, still required a limited albeit costly maintenance programme when faced with reduced income. The irrigation system was re-commissioned and the green cut less frequently along with verti-cutting and the Compost Tea treatment applied. In 2020, an expenditure of £5,093 was incurred on green maintenance and £655 on machinery & equipment.

In 2021, green maintenance work resumed. However, the GPC decided that to ensure more safety compliance of Club members regarding Covid-19, no league matches or friendly fixtures were to be played-only the domestic competitions. This, of course, minimised wear and tear of the green. However, storm Arwen in November caused havoc with debris scattered all over the green and also severely damaged the fence alongside the public footpath. Repairing the fence cost £800. The use of rink mats helps protect the surface but unwanted presence of nails could severely damage the mower. An expenditure of £4,958 was incurred on maintenance work and £437 on machinery & equipment.

In 2022, the Green Ranger's Notice Board showed how, when protection mats are used, the green could still be damaged inadvertently during play. However, when not in use, some damage occurred during both casual play and matches. Following closure of the bowling season in August, the green was cut and scarified during

September. Later, on receiving advice from consultants, coarse sand was injected into the bowling green to minimise the dry patches and improve its water penetration. Hopefully, it would also stabilise the soft areas at the southern end of the green. Using protective mats had caused problems by having to ensure no nails were left in the turf on removing the mats after a game. An expenditure of £9,017 was incurred on maintenance of the green and £289 on machinery & equipment.

In 2023, inclement weather in April delayed opening of the green. July being the sixth wettest month on record both ducks and geese were to be seen enjoying time on the green. The efforts of the Green Ranger and his team were rewarded when the majority of the scheduled events were completed albeit with three postponements of President's Day in July, August and September. An expenditure of £6,745 was incurred on maintenance of the green and £721 on machinery & equipment.



**PBC green following unseasonable weather, July 2023**



**River Pont ducks and geese enjoying a change of scenery, July 2023**

When the Club's amenities improved following the building of a Clubhouse the combined membership of the Ladies' and Men's Sections increased from 63 in 1975 to 200 in 2003. Since then, unfortunately, a steady decline in membership occurred it being down to 100 in 2020 at the time of Covid-19 of which only 89 were full members. Following the combined efforts of members in a post - Covid-19 recruitment campaign brought a significant increase in membership to 155 in 2023, of which 133 were full members. However, excluding members' competitions, a two-thirds increase in home fixtures from 71 in 1975 to 123 in 2023, has caused additional wear and tear to the green and extra expenditure. Another contributory factor has been arranging of too many consecutive home fixtures during the season, viz. fifteen in August / September, 2004 but the situation was much improved when reduced to seven in August 2023.

For members interested in statistics, during the 10-year period, 1991- 2000, the average annual expenditure on green maintenance was approximately £4,000 plus machinery & equipment costs of £500. These costs may be compared with the latest period, 2007- 2023, the corresponding items averaged £7,000 and £1,474. Incidentally, taking into account the effects of inflation, green maintenance cost is similar, whereas the cost of machinery & equipment increased by two-thirds.

Clearly, from the above annual reports, green maintenance costs over the years varied considerably and, in earlier times, with insufficient funds available, only limited remedial work was possible with the aid of voluntary labour. From the available Financial Statements the total expenditure each year on the maintenance of the bowling green and its surrounds i.e. wages, new equipment, repairs and improvements are presented below.

Year	Maint. £	Mcy £	Total Exp. £
2007	8,248	860	18,503
2008	7,794	468	18,142
2009	5,378	556	31,046
2010	5,086	439	20,048
2011	7,016	575	19,137
2012	8,869	5,652	26,487
2013	5,963	369	16,665
2014	6,048	10,034	27,907
2015	4,177	1,489	17,835
2016	10,986	0	23,355
2017	5,694	66	21,037
2018	11,655	1,058	26,807
2019	6,282	1,389	21,391
2020	5,093	655	14,519
2021	4,958	437	9,660
2022	9,017	289	19,379
2023	6,745	721	23,518
<b>Total</b>	<b>119,009</b>	<b>25,057</b>	<b>354,938</b>
<b>Average</b>	<b>7,000</b>	<b>1,474</b>	<b>20,878</b>

**Total Maintenance & Machinery Costs during the period 2007- 2023 were £144,066 ie. 40.6% of Total Capital Expenditure.**

Year	%	Year	%
1970	28	1999	47
1971	61	2000	47
1972	N/A	2001	29
1973	N/A	2002	32
1974	49	2003	23
1975	52	2004	54
1976	71	2005	48
1977	N/A	2006	46
1978	N/A	2007	49
1979	54	2008	45
1980	66	2009	16
1984	61	2010	27
1985	72	2011	39
1986	48	2012	55
1987	58	2013	38
1988	83	2014	58
1989	63	2015	32
1990	76	2016	47
1991	35	2017	26
1992	38	2018	48
1993	70	2019	36
1994	24	2020	40
1995	28	2021	56
1996	51	2022	48
1997	80	2023	32
1998	50		

**Total Green-Maintenance Costs during the period 1970- 2023  
as a Percentage of Total Capital Expenditure**

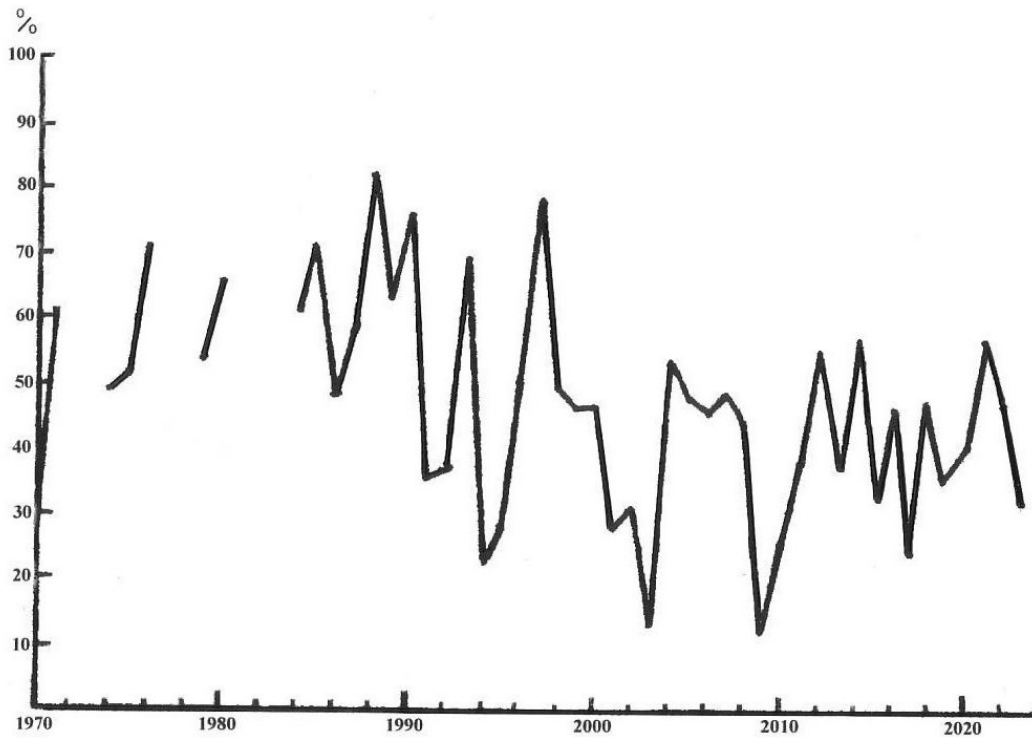

**Total Green-Maintenance Costs as a Percentage of Total Capital Expenditure**



**PBC Members celebrating the 2010 “Northumbria In Bloom” Silver Gilt Medal Certificate. Also, in picture, (l - r) : Ponteland Mayor Robin G. Ramsay, Cllr Joyce Butcher and Cllr Liz Thompson**



**PBC members celebrating the 2012 “Northumbria In Bloom” Gold Medal Certificate presented to Nan Caldwell by Ponteland Cllr Joyce Butcher**





**Silver Gilt Medal Certificate Awards,  
2010, 2011, 2015 & 2018**



**Gold Medal Certificate Awards,  
2012, 2013, 2014, 2016 & 2017**

## 8

### Pavilion / Clubhouse Projects

This section describes the endeavours of members over the years with the help of local authorities and National bodies to improve the amenities at the Club.

Following its formation in 1923, Club members were confined to the use of a small wooden building.

In 1933, the PBC Committee, mainly through the efforts of both the Chairman, H. Beecham, and the Secretary, W. Barrons, in raising public monies the first but inadequate wooden structure was replaced with a 28ft. x 12ft. brick building at a cost of £230. The new Pavilion was opened on Saturday, the 5th May 1934, by the President, J. Hilton, with approximately 40 members, 18 ladies and friends in attendance. Fourteen months later, the building was free from debt. The door key to the Pavilion was officially passed on to the PMH Trustees on the occasion of the annual concert given by the Whitley Bay Male Voice Choir.

In 1937, continuing efforts by the PBC Committee saw the provision of seating around the bowling green, mainly funded through regular Whist Drives. The seats were passed on to PMH Trustees in May 1938. Perhaps, somewhat surprisingly, it was not until the Spring meeting was held in April 1941, that amenities in the Pavilion were improved with the installation of a toilet and wash hand-basin at a cost of £30. The members expressed their gratitude to the Vice Chairman, R.L. Davison, for his generous donation towards the cost. His cheque for £13. 2s. 0d was the proceeds from the sale of 307 copies of the booklet he had prepared entitled "A History of the Ponteland War Memorial" . Later on, bowls lockers were installed. In 1949, G.A. Hall provided a provisional plan of the suggested alterations to further improve the facilities in the Pavilion. In 1950, a lean-to extension was built on the south side of the Pavilion, providing a garden tool and machinery store, at a cost of £92. The necessary funding was obtained from a Jumble and Bring & Buy Sale organised by the Ladies' Committee.



Official Opening of Ponteland Bowling Club  
Pavilion by the President, J. Hilton, 5th May, 1934.

Chairman : H. Beecham    Secretary : W. Barrons

In 1951, a glass-covered veranda was erected alongside the front of the Pavilion, at a cost of £48. Afterwards, electricity was installed in the Pavilion which comprised of three 5 ampere lighting points and one 15 ampere power outlet, at a cost of £8 12s. 0d. The first General Committee meeting was held, with the benefit of heating and lighting, on the evening of the 16th October 1951. In 1956, an additional 21 lockers were installed in the Pavilion, at a cost of £25.

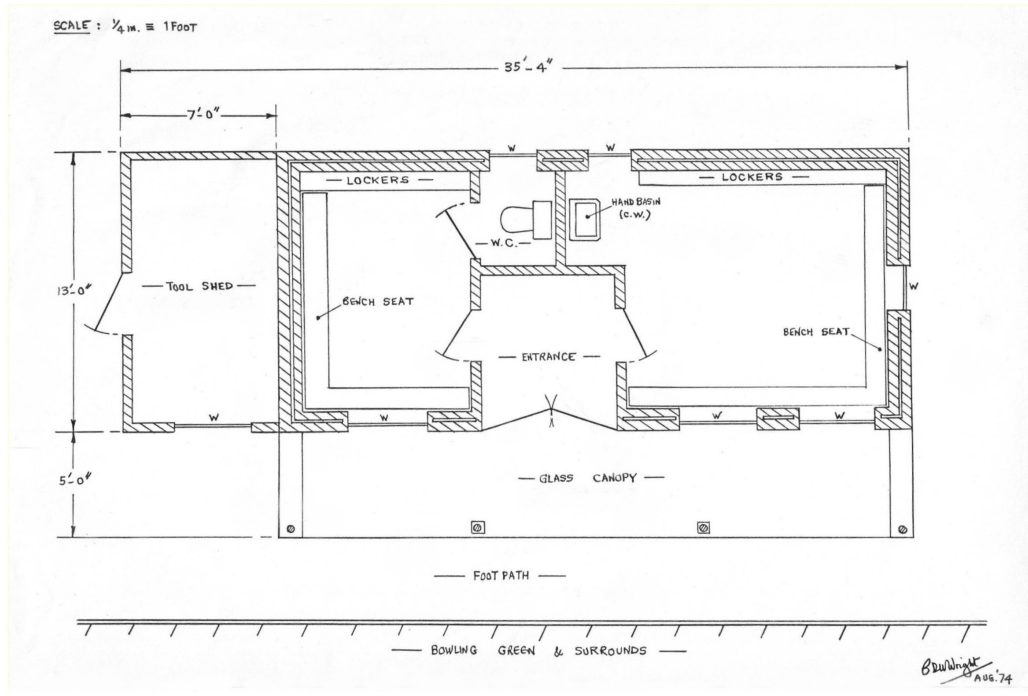

PBC Pavilion Erected in 1934.  
Tool Shed Erected in 1950.  
Glass Veranda Erected in 1951.

With the formation of the Ladies' Section, on the 15th June 1967, and with limited accommodation available in the Pavilion, it was imperative to provide additional facilities at the Club. In 1974, it was agreed that the Men's Secretary, a member of PMH Committee, should put forward his proposal to them for extending the Pavilion which was approved. Preliminary plans were then prepared by B.D.W. Wright in August 1974, for consideration by the GPC. The first, provided a 30ft. brick-built extension on the north side of the Pavilion which included a kitchen, additional toilet facilities, additional locker space and bench seating. An alternative plan showing a 30ft. x 20ft. extension on the south side of the Pavilion provided, in addition to the above facilities, sufficient floor space for two rinks of carpet bowls. Shortly afterwards, however, it came to the attention of the GPC that a substantial RAF-type cedar wood building, 30ft. x 20ft., was available at a cost of £1,000 which could be erected alongside the southern end of the Pavilion. At additional cost, the building would need a sound foundation with floor tiles and be fitted out with a kitchen, toilets, also electric lighting and power points. Planning permission was received from the local Council, and with the approval of Club members and PMH Committee it was decided to purchase the cedar wood building. Discussions had already taken place with the Darras Hall Estate Committee (DHEC) who advised that before the building could be erected it was necessary for the Club to obtain a legal discharge of the restrictive covenant regarding the 50ft. building line. This was unexpected, as the existing Pavilion layout already breached the 50ft building line. Following consultation with PMH Management Committee, it was recommended that

the Men's Secretary obtain the services of a solicitor having the necessary expertise in Land Tribunal matters. In addition, the members wished to be indemnified in any legal proceedings in connection with the project.

Meanwhile, DHEC sought the views of immediate local residents. An objection was lodged because some trees would need to be removed, and it was considered the building would be unsightly when the remaining deciduous trees were bereft of leaves during the winter months. Over a period of months, further discussions ensued between the parties concerned, and it was finally decided it would be in the best interests of the Club if an alternative Pavilion proposal was made. The Secretary volunteered to submit plans for a brick-built Pavilion when the cedar wood building was sold. Fortunately, a local Boy Scouts Group bought the building shortly afterwards, at the price previously paid by the Club.

Building plans drawn up by the Secretary for the proposed Pavilion were approved by the local authorities in January 1977, and A.B. Wood, the Club's solicitor from Ingledew Mark Pybus, Newcastle was instructed to prepare a brief for the Lands Tribunal. At an EGM the Secretary was given the authority to act on behalf of all Club members in indemnifying PMH Trustees against any costs arising from proceedings at the Lands Tribunal. Of concern, was the possibility of claims for compensation by local objectors to the Pavilion project. On the 3rd August 1977, PMH Trustees granted a licence to occupy the bowling green premises subject to the terms and conditions set out in the Schedule to the Licence. At an EGM of the combined membership, held on the 29th November 1977, it was agreed that the liability of individual members should not exceed £20. The Club itself, would have a maximum commitment of £1,750 in any costs, following the advice of our legal representative. members were advised that if they were unwilling to accept this undertaking they would be required to resign from the Club. No objections were raised publicly or privately by the members at the meeting. Events arising from this particular item are outlined in Section 1.1.

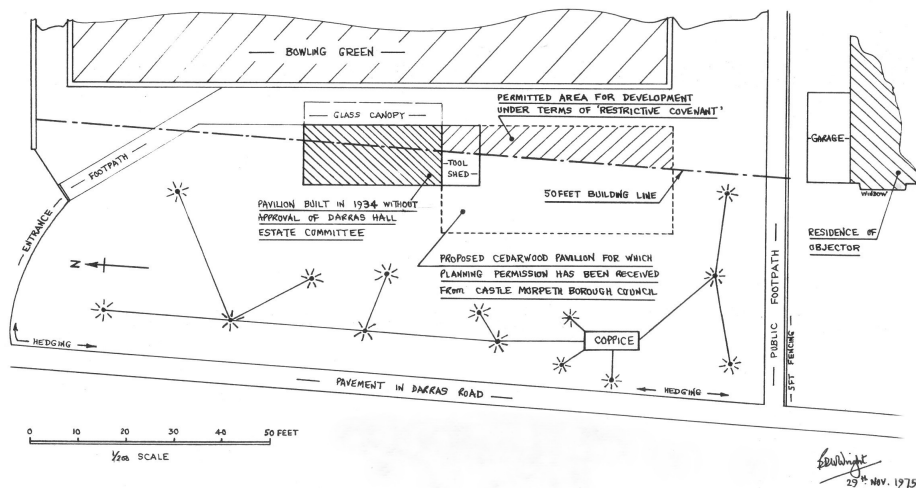

### Proposed Cedar Wood Pavilion, 1975

The Lands Tribunal was held in Newcastle on the 18th and 19th January 1979, with the Men's President, the Men's Secretary and the Club's solicitor in attendance. Representatives from PMH Committee, DHEC and a local objector to the Pavilion scheme also attended the hearing. A Consent Order for the legal discharge of the restrictive covenant was granted by the President of the Lands Tribunal, but with unacceptable conditions for the Club. The building work had to be started within twelve months, and in that event, the local objector to the Pavilion scheme would be awarded £1,000 in compensation. Furthermore, behind the Pavilion, a non-deciduous tree screen

had to be erected parallel to Darras Road, and no application to be made to the Courts in respect of the alcohol restriction contained in the Darras Hall Trust Deed. Also, the building plans, drawn up by the Men's Secretary and passed by the local planning authority in June 1976, had to be modified to reduce the length of the Pavilion from 60ft. down to 50ft. A tool equipment room could be erected, elsewhere, provided it did not encroach upon the 50ft. building line.

Arising from the litigation brabout by a Darras Road resident and the DHEC, their legal costs were slightly less than the agreed sum of £1,750 imposed by the Club's solicitor. Regarding the Club's expenses, the Secretary of the Men's Section had been associated with the project for more than four years, and had personally prepared the building plans and other drawings at no cost to the Club. Submissions for grant-aid and planning permission, also discussions with local authorities, entailed over 250 letters in correspondence. The Club solicitor had expenses and professional fees during this period which were reasonable, but the agreed total liability costs of £1,750 meant he could only receive payment of less than £100. Because of the overbearing financial implications from the Consent Order received at the Lands Tribunal, the Pavilion project was cancelled.

Following the Lands Tribunal judgement, an EGM was held in PMH on the 9th March 1979, attended by 51 members, a combined total of over 80% of the Ladies' and Men's Sections in attendance. The Men's Secretary informed members that he had drawn up new building plans which were acceptable to both the local planning authority and DHEC. Submissions for grant-aid also had been made, and it again required the Club to raise 25% of the building costs. In addition to the inflationary climate prevailing in the country at that time, the estimated cost of the new project had risen to £11,000 from the £6,000 originally estimated in 1975. The Club would be required to pay a rent of £1,040 p.a. for 25 years covering the interest and repaying the loan capital. It was clear from the ensuing discussion that some members were unhappy with the prospect of raising the necessary 25% towards the cost of the Pavilion. A vote-of-confidence was taken to decide the future of the project, but the majority decision in favour of its continuation was less than the 2/3rds majority requested by the Men's Secretary. Most disappointed at the result of the ballot, the Secretary thanked all members who had in any way supported him in his efforts to re-vitalize the Club with the building of a new Pavilion. Members who subscribed to the fund-raising schemes for the Pavilion would have their contributions returned. Finally, members were reminded of their obligation to remit the £20 liability now payable to cover the legal costs arising from the Lands Tribunal proceedings. Following the cancellation of the Pavilion project, B.D.W. Wright informed the members of his decision to resign from the position of Secretary and membership of PMH Committee.

David Batten, the Secretary of the NPFA, in writing to the Parish Council and the Trustees of PMH, expressed his regret at the resignation of B.D.W. Wright, the Men's Secretary, over the Pavilion affair. Possible problems relating to the 50ft building line had first been considered in 1975, before building plans for a new Pavilion were prepared by the Secretary. At that time, to no effect, the Secretary had approached PMH Committee to explore the possibility of a joint venture with the Tennis Club for erecting a Pavilion above the lounge in the Memorial Hall. The matter was raised again in 1979, without success, and PMH Committee suggested that the Club make use of its changing room facilities along with the Tennis Club .

In October 1979, the GPC decided that J. English should write to PMH Secretary drawing attention to the need for repairs to the Pavilion viz. roof tiles, guttering, wood flooring, veranda roof, broken windows and improvement in toilet facilities. It was estimated that this work would cost PMH Trustees approximately £1,150. In view of this, only items requiring urgent repair were attended to in the closed season. In connection with the proposed face-lift for the Pavilion, PMH Committee suggested that the Club consider a possible lengthwise extension of the Pavilion. The loan capital would be

raised and repaid by PMH Trustees, with the Club having to pay a rent equal to the interest charged on the capital which would qualify for some grant-aid. B.D.W. Wright, at the request of the GPC in February 1980, again prepared outline plans of a proposed modification to the Pavilion having overall dimensions of 42ft. x 19ft. Copies were sent to PMH Trustees for estimates of the possible cost of the project.

Further to this, a GPC meeting was held in December 1980, and four alternative plans were considered which had been prepared by both H. Buckley and N.I. Younger. The plan finally adopted, and approved by the local authority, in January 1981, entailed the removal of the glass veranda and the west wall of the existing Pavilion. A new wall extending outwards towards the bowling green to be built, adjacent to a 3ft. path along the bank-side. The external walling to be built with the facing bricks remaining following PMH extension. Two toilets were to be provided, also space for 54 lockers and bench seating. The existing tool shed to be converted into a wall-tiled kitchen. A separate wood-built equipment store to be erected on the south side of the Pavilion. In addition to the grants total of £2,625 received from the local authorities, PMH Trustees contributed £450 towards the project in lieu of previously agreed repairs. The estimated cost of the alterations exceeded £5,000.

In April 1982, the extended Pavilion was officially opened by the Mayor of CMBC, Cllr W.J. Lough. In addition to the Club Officers, other attendees were Mrs N. Lough the Mayoress, Mr L. Dewhirst (Chairman, PPC), Mr D. Adams (Treasurer, PMH), Mr W. Baldock (Secretary, PMH), Mr Dunlop (Sports Council representative), Mr J. Dixon (President, NCBA), Mesdames Adams, Baldock, Dewhirst and L.H. Loughton (PBC).

The alterations to the Pavilion, in 1981 and 1982, provided additional space with three large uPVC window frames fitted with double-glazed units but some elements of the original Pavilion remained.

In 1991, emergency repairs were necessary to replace some flooring, an upgrading of the hot water heater in the kitchen, and the provision of hot water in the toilets. Also, the laying of carpet tiles, re-painting the doors and window frames was undertaken. The cost of this maintenance and repair work amounted to over £2,200 including an ex- gratia payment of £150 for voluntary work undertaken by a Club member. In addition, a new wooden equipment store was erected.

In 1994, dry rot was found in the flooring in way of the lockers. At the same time, when repairing the floor, it was decided to dispose of the wooden lockers and provide metal lockers at a total cost of £1,300. Later on, a proposal to erect a separate modular building, 7.5m. x 3m., along the west side of the Pavilion was rejected by the members

In 1995, it was decided to consider the possibility of extending the Pavilion by 6m. at each end to provide separate changing room and toilets. It was estimated the total project, which included an upgraded kitchen, an extended social area and an automatic watering system for the bowling green, would cost approximately £54,000. However, in 1996, the project was abandoned in favour of erecting a new Clubhouse, and an application was made to the National Lottery Commission (NLC) for a grant towards the project costs, estimated at £55,000, with the members providing not less than 35% of the total cost. A year later, the application required amendment to satisfy the requirements of the NLC on equal membership rights. As the membership of the Club was not fully integrated, some changes were required to its Constitution. At that time, there were doubts, however, whether 75% of the members would be in favour of the change. In view of this, and with any extra building costs arising from possible delays, the project was cancelled yet again.

Further maintenance of the Pavilion was required in 1998, at a cost of £1,600, with the replacement of the hardwood entrance door and windows. In 1999, further repairs to the flooring were carried out.

FRONT ELEVATION (LOOKING WEST)

SCALE: 1/4" = 1'00"

- NOTES:
1. BALCONY EXTENDED OVER AS MINIMUM HALL - INACCESSIBLE YARDING.
  2. CONCRETE FLOOR TYPICAL.
  3. THERMOPLASTIC VINYL-FLOOR TILES 18" x 18".
  4. FRONT EXHIBIT STORAGE (EXHIBIT) IN ROOMS HALLWAYS OFFICE SPACE.
  5. PVC SHALL STORED IN LOCATIONS APPROPRIATELY DESIGNATED.



PLAN OF PROPOSED MODIFICATION TO PAVILION (42' x 19')

SCALE: 1/4" = 2 FEET

- C - CUP WIRE WARE SUPPLY
- W - WINDOW
- H - WALL MOUNTED HEATER
- F - FIRE EXTINGUISHER
- L - LIGHTING SWITCH

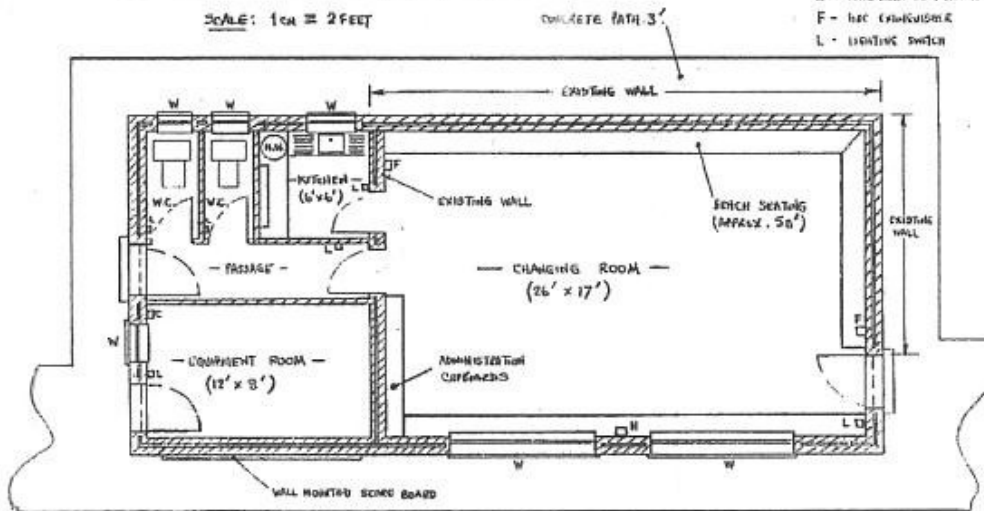

— BOWLING GREEN —

*Handwritten signature and date:*  
16/3/80

**Proposed Modification to Pavilion, February 1980.**



**Pavilion Extension Working Party Members, 1982**

**(l - r) : John Duff, Norman Younger and Eric Scholes**

**(l - r) : Norman Younger, John Duff and Tom McPhee**

**Absent : Tom Cuthbert**



**Pavilion Extension, 1982 - Southern View**





**Pavilion Extension, 1982 - Northern View**

**In recent years, considerable expenditure was incurred in providing a bowling green considered by visitors, and more importantly by members, to be among the best in the County. However, this could not be said of the existing Pavilion facilities. The limited accommodation and amenities provided by the previous extension carried out in 1982, hardly met the needs and expectations of 130 members from both Sections of the Club. Wall space was at a premium for displaying notices and honours boards. Although the necessary repairs and maintenance of the building had been carried out, it became increasingly more apparent that a new building was required with the total membership approaching 200.**

**In 2000, it was decided to prepare plans for the provision of a Clubhouse, with much improved facilities, to cater for the large membership. An application for grant-aid was made to both the Foundation for Sport and the Arts (FSA). The EBA granted an interest-free loan of £20,000 repayable over a 5-year period. This would be subject to the members' providing guarantors of £2,000 or £1,000 to cover the loan. Twelve members supplied the requisite guarantee. Also, in addition, PPC had contributed with a £500 donation, and some of the members subscribed with donations and interest-free loans over 3- and 5-year periods.**

**Further to the application for NLC funding of an earlier project in 1996, it was decided to make another attempt in 2001 and plans for a new £120,000 Clubhouse scheme were drawn up. It comprised of a building with a red-tiled hip roof, uPVC doors and window frames fitted with double-glazed units from the existing Pavilion. The necessary specification required the facing bricks for the exterior walls to match those of PMH extension. The amenities included separate changing rooms, toilets and a toilet for disabled persons, kitchen, Committee room, social area, and an 8m. long veranda overlooking the green.**

**Following careful consideration of the financial implications for the membership, it was agreed that the cost of the building, including all fittings, should not exceed £100,000. It was decided, therefore, to dispense with the proposed veranda**

and amend the original specification to reduce the floor space area by 24 sq. m. Accordingly, the Pavilion length was reduced by 3m. at the southern end, giving an overall length of 17m. It was also decided that, if required, any future extension would be made at the northern end of the Pavilion. A grant of £30,000 was eventually made available by the FSA. The grant had been dependant on the PMH Trustees providing the Club with a lease rather than a licence. However, a lease entailed the Club paying the PMH Committee a fixed sum of approximately £2,800 p.a. rather than the present annual charge of £560. Following representations by the PMH on behalf of the Club, the FSA accepted the existing PMH licence but with an extension until 2030. Clarification of the legal position, and satisfying the requirements of the FSA, took up much of 2002. Another nightmare scenario occurred in 2003, when an investigation, of several months duration, was carried out to determine whether the Club should or should not have been registered for payment of V.A.T. at 17.5%. This amounted to adding approximately £18,000 on the building costs. Further delay was experienced in re-claiming the V.A.T. from H.M. Customs and Excise, and "salt was rubbed in the wound" when eventually finding that only £13,000 had been allowed.

During this period, further donations of £1,000 and £500 respectively, were received from the Joicey Trust and the Northumberland County Council via its Small Grants Scheme.

Meanwhile, in June, 2002, the Pavilion was subjected to a break-in by a misguided youth. Measures to prevent vandalism had first been raised with the PMH Committee by the Secretary of the Men's Section in 1978.

The GPC awarded the 10-week contract for building the Clubhouse to Mears Construction (Northern) Ltd, Morpeth with Management consultant, Richard Sullivan, who was appointed to oversee the project on behalf of the FSA. The GPC requested that five members should form a Building Advisory Committee. Those co-opted were G. Webb, W.R. Liddle, H. Robson, T.N. Robson and Club Lady Chairman, M.E.H. Nesbit.

The existing building was demolished early in January 2003 and work on the new foundations began shortly afterwards. The Clubhouse was completed and formally passed on the 25th March, 2003 by Mr R. Sullivan, the Management Consultant, in good time for the Opening Day on the 19th April, 2003. The greatly improved facilities have been much appreciated by the membership and visiting teams. However, the financial constraints which necessitated reducing the overall length of the building to 17m. entailed insufficient space in both changing rooms and the main hall.

Arising from the proposed 2009 structural changes to local government in England, CDMC would be abolished and its responsibilities transferred to Northumberland County Council a unitary authority. Apart from any political consequences, it proved to be a blessing in disguise for the Club. In 2008, CMDC indicated that substantial resources were still available in their Community "That Extra Mile" fund. Grant applications would be favourably considered subject to completion of projects before the financial year ending in April, 2009.

In view of this, an EGM was held in May 2008 and members agreed to take the once in a lifetime opportunity of extending the length of the Clubhouse by 4m. at the southern end. This would double the size of the changing rooms, also provide a disabled toilet and increase the space in the main hall for social purposes by 33 square metres. Mr A. Tunnah of CMBC also attended the meeting to explain funding opportunities and was of great assistance to the Treasurer with the grant applications to finance the estimated cost of the project, viz. £53,640. The Community Fund application was approved in September, 2008 with a substantial grant of £31,640. Following the successful application to the EBA in 2002 for an interest-free loan of £10,000 it was decided to apply to Bowls England for another interest-free loan of £10,000 repayable over eight years which again was successful.



**Pavilion Break-in, June 2002**



**Clubhouse completed in March 2003**

**Following on from his experience with the original Clubhouse project in 2003, G. Webb agreed to assist the architects, Dickinson Associates, and the builders, A & S Kerr, in management of the project.**

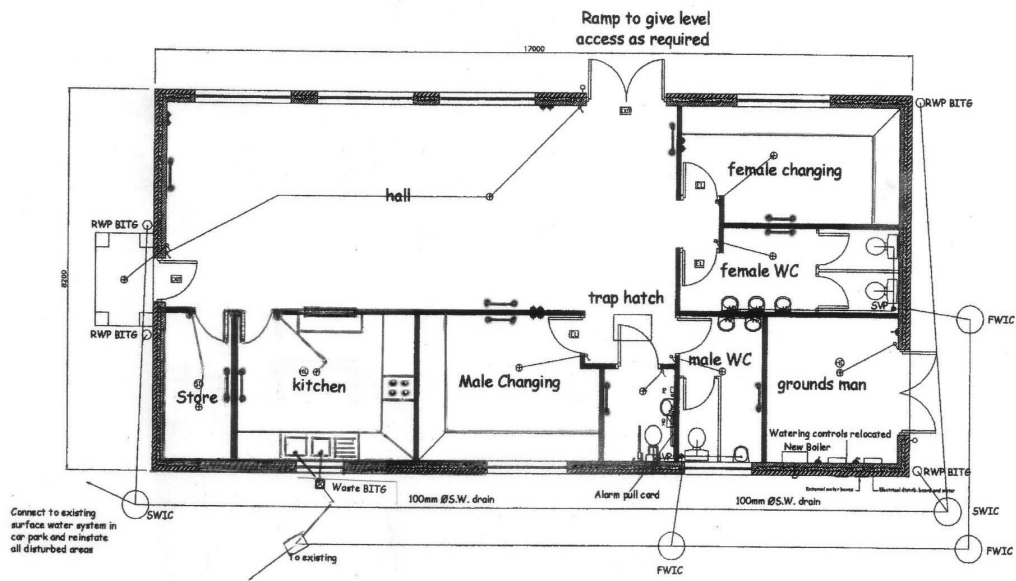

**Layout of Clubhouse, March 2003**



**The Clubhouse was completed and formally passed on to the Lady Chairman by the Management Consultant on the 25th March, 2003**

(l - r) : Betty Nesbit, Richard Sullivan, George Webb (Project Manager)



Clubhouse extension completed in March 2009

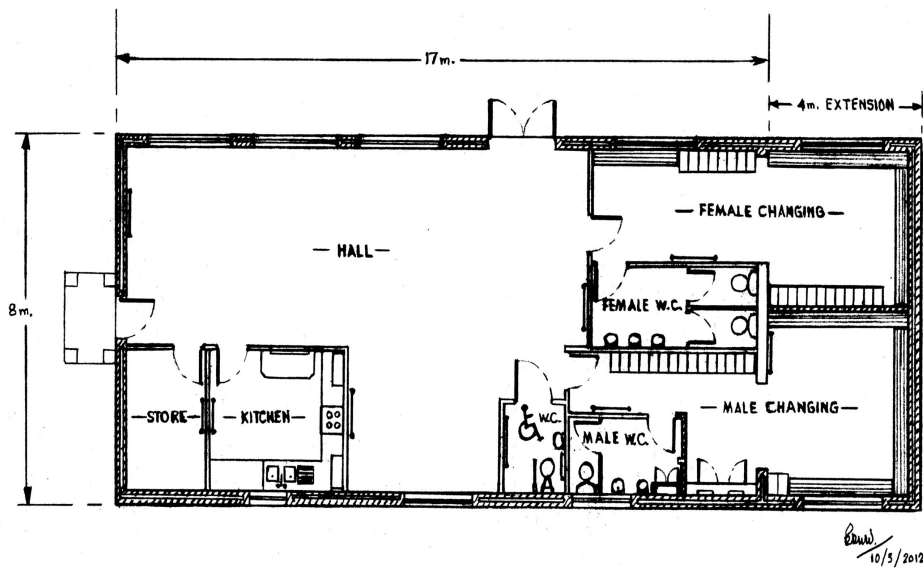

Layout of extended Clubhouse, March 2009



**Patio and memorial garden area completed in September 2009**

**The actual cost of the Clubhouse extension was £41,579 which provided the opportunity to clear the waste ground in the south-west corner and to landscape the site. At the same time, it was thought that the construction of a patio area beside the Clubhouse would enhance outdoor social activities. For this purpose, extra funding of £10,000 was sought from the “Awards for All” Big Lottery Fund which proved unsuccessful. However, with the interior work in the Clubhouse not costing as much as planned the patio area and paved surrounds were completed. Further information on these projects may be found in the PBC archives.**

**In 2022, the GPC et al considered the condition inside of the Clubhouse to be rather uninviting for members and visitors. It was decided to carry out a complete refurbishment of both interior and outside paintwork. The GPC recorded their gratitude to A. Barratt for his excellent efforts on painting the entire Clubhouse. Additional work included the fitting of energy efficient LED lighting. The electrical installation now complies with legal current requirements. The Clubhouse interior was further enhanced with the removal of curtaining and fitting of window blinds.**

# 9

## Modified Retail Price Indices, 1919 - 2023

The modified Retail Price Indices can be applied directly to the Club Treasurer's figures in any year to afford comparison with values in 2023.

*Example* : £100 in 1960 would be worth  $£100 \times 66.06 / 2.24 = £2,949$  in 2023.

Conversely, £100 in 2023 would have been worth  $£100 \times 2.24 / 66.06 = £3.70$  (actually £3 14s. 0d) in 1960.

Year	Index	Year	Index	Year	Index
1919	1.00	1954	1.89	1989	20.75
1920	1.15	1955	1.97	1990	22.72
1921	1.05	1956	2.07	1991	24.05
1922	0.91	1957	2.14	1992	24.95
1923	0.85	1958	2.21	1993	25.35
1924	0.85	1959	2.22	1994	25.96
1925	0.85	1960	2.24	1995	26.86
1926	0.84	1961	2.32	1996	27.51
1927	0.82	1962	2.42	1997	28.37
1928	0.82	1963	2.46	1998	29.34
1929	0.82	1964	2.55	1999	29.79
1930	0.79	1965	2.67	2000	30.67
1931	0.76	1966	2.77	2001	31.22
1932	0.74	1967	2.84	2002	31.74
1933	0.72	1968	2.98	2003	32.66
1934	0.72	1969	3.13	2004	33.63
1935	0.73	1970	3.34	2005	34.58
1936	0.73	1971	3.65	2006	35.68
1937	0.76	1972	3.91	2007	37.21
1938	0.77	1973	4.27	2008	38.70
1939	0.79	1974	4.95	2009	38.49
1940	0.92	1975	6.15	2010	40.27
1941	0.92	1976	7.17	2011	42.36
1942	1.09	1977	8.31	2012	43.73
1943	1.13	1978	9.00	2013	45.05
1944	1.16	1979	10.20	2014	46.12
1945	1.19	1980	12.04	2015	46.57
1946	1.23	1981	13.47	2016	47.38
1947	1.32	1982	14.63	2017	49.08
1948	1.42	1983	15.30	2018	50.41
1949	1.46	1984	16.06	2019	51.67
1950	1.51	1985	17.04	2020	52.60
1951	1.64	1986	17.62	2021	53.91
1952	1.79	1987	18.35	2022	59.68
1953	1.85	1988	19.25	2023	66.06

# 10

## PBC Officials

### 10.1 Combined Sections (2000 - 2023)

Year	Chairman
2000	R.B. Baxter
2001-2003	Mrs M.E.H. Nesbit
2004-2005	J.T. Harrison
2006-2008	A.O. Christie
2009-2011	R.J. Varley
2012	Mrs N. Caldwell
2013-2015	J.D. Cowings
2016-2018	R. J. Varley
2019-2021	P. Kilmister
2022-2023	R.D. Redhead

Year	Secretary
2000-2002	A. Wilson
2003-2005	Mrs E. Donkin
2006-2012	Mrs M. Cowan
2013-2016	D.W. Kirk
2017-2018	Ms S.A. Storey
2019-2020	D.W. Kirk
2021-2023	D. Burbeck

Year	Treasurer
2000-2001	E.W. Lowthian
2002-2007	R.J. Varley
2008-2016	J.T. Harrision
2017-2022	Miss J. Barras
2023	Miss A. Shipley

Year	Auditor / Scrutineer / Examiner
2000	K. Hunter
2001-2013	A.D. Barritt
2014	R.A. Bull (pro tem)
2015-2016	A.D. Barritt
2017-2022	F.S. Cowan



## 10.2 Men's Section (1932 - 2023)

Year	Chairman
1932-1941	H. Beecham
1942-1950	W. Barrons
1951	H.B. Stobert
1952	J. Oliver
1953	T. Scott Bell
1954	W.V. Reed.
Year	Vice Chairman
1936-1944	R.L. Davison
1945-1948	J.G. Dawson
1949-1950	H.B. Stobert
1951	J. Oliver
1952	T. Scott Bell
1953	W.V. Reed
1954	W.S. Douglas.
Year	President
1932-1935	J. Hilton
1936-1948	J. Henderson
1949-1951	H.S. Robinson
1952	K.B. Straughan
1953	T. Fatkin
1954	J. Oliver
1955	R.F. Pascoe
1956	W.V. Reed
1957	C.F. Jameson
1958	J. Carr
1959	E. Forster
1960	W. Weightman
1961	C.R. Ions
1962	W.S. Douglas
1963	W. Mole
1964	P.L. Lloyd
1965	C.F. Jameson
1966	J. Loughton
1967	A. Robinson
1968	L.R. Mankin
1969	T.W. Cuthbert
1970	J. Irvine
1971	W.L. Hepple
1972	T. Mills
1973	J. Oliver
1974	H. Emery / J. Oliver
1975	T.F. Cattliff / B.D.W. Wright
1976	B.D.W. Wright
1977	J.H. Lees
1978	J. Carr
1979	T. McPhee
1980	J. English
1981	E. Scholes
1982	A.H. Baker

<b>Year</b>	<b>President contd</b>
1983	J.W. Atkinson
1984	J.S. Duff
1985	G.D. Bennett
1986	R. Elder
1987	J.W. Nesbit
1988	S.A. Swift
1989	E.S. Johnson
1990	W. Ridley
1991	J. Graham / E.S. Johnson
1992	R.I. Shuttleworth
1993	T. Lumley
1994	R. Stafford
1995	D. Gibb
1996	K. Griffiths
1997	G. Goldie
1998	A.M. Maclean
1999	R.B. Baxter
2000	P. Telfer
2001	G.D. Bennett
2002	A.O. Christie
2003	K. Hunter
2004	W.R. Liddle
2005	E.W. Lowthian
2006	H. Robson
2007	J.T. Harrison
2008	R.J. Varley
2009	H. Robson
2010	M. McDonnell
2011	J.D. Cowings
2012	D.W. Kirk
2013	D. Franks
2014	H. Howell
2015	P. Kilmister
2016	M. Anderson
2017	G. Lord
2018	A.O. Christie
2019	P.A. Dodds
2020	R.J. Varley
2021	R.D. Redhead
2022	G. Lord
2023	P. Kilmister

<b>Year</b>	<b>Secretary</b>
1932-1940	W. Barrons
1941-1945	J. Carr
1946-1952	E. Stokoe
1953-1954	E. Forster
1955-1956	A. Attwater
1957-1963	G. Latham
1964-1966	E. Forster
1967-1973	H. Emery
1974	H. Emery / B.D.W. Wright
1975-1979	B.D.W. Wright

<b>Year</b>	<b>Secretary contd</b>
1980-1981	J. English (acting position)
1982-1988	J. Graham
1989-1998	A.M. Maclean
1999-2000	A. Wilson
2001-2003	R.A. Peckham
2004-2005	A. Wilson
2006-2008	T.N. Robson
2009-2011	D.W. Kirk
2012-2014	D.W. Morrison
2015	A. Barratt
2016-2017	J. Taylor
2018	D.W. Kirk
2019	W.R. Liddle
2020-2021	D. Burbeck
2022-2023	I. Gordon

<b>Year</b>	<b>Treasurer</b>
1932-1937	J. Porteous
1938-1943	J. Pyle
1944-1971	R.F. Pascoe
1972-1977	J.H. Lees
1978-1980	J. English
1981	J.C. Tingcombe
1982-1989	J. English
1990-1991	H. Davis
1992-1998	R.B. Baxter
1999	E.W. Lowthian

<b>Year</b>	<b>Auditor</b>
1934-1951	G. Adam
1952	J. Mitchell
1953-1961	E. Dodds
1962-1971	J. Carr
1972-1978	R.F. Pascoe
1979	J.C. Tingcombe
1980-1983	G.D. Bennett
1984-1998	F. Wilson
1999	K. Hunter

## Men's Section Presidents (1949 - 1970)

Not all of the photographs were taken during their period in office



**H.S. Robinson**  
1949 - 1951



**K.B. Straughan**  
1952



**T. Fatkin**  
1953



**J. Oliver**  
1954

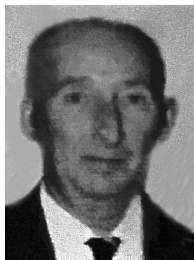

**R.F. Pascoe**  
1955



**W.V. Reed**  
1956



**C.F. Jameson**  
1957



**J. Carr**  
1958

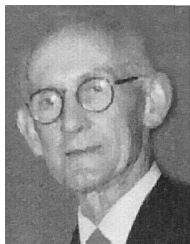

**E. Forster**  
1959

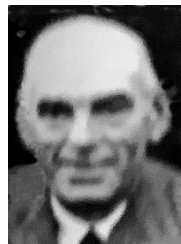

**W. Weightman**  
1960



**C.R. Ions**  
1961



**W.S. Douglas**  
1962



**W. Mole**  
1963



**P.L. Lloyd**  
1964



**C.F. Jameson**  
1965



**J. Loughton**  
1966



**A. Robinson**  
1967



**L.R. Mankin**  
1968



**T.W. Cuthbert**  
1969

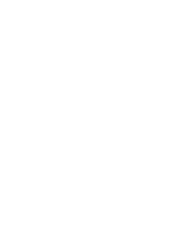

**J. Irvine**  
1970

## Men's Section Presidents (1971 - 1990)

Not all of the photographs were taken during their period in office

+ Sadly, Harry Emery and Tom Catliff passed away whilst in office



**W. Hepple**  
1971



**T. Mills**  
1972



**J. Oliver**  
1973



**H. Emery +**  
1974



**T.F. Catliff +**  
1975



**B.D.W. Wright**  
1976



**J.H. Lees**  
1977



**J. Carr**  
1978



**T. McPhee**  
1979



**J. English**  
1980



**E. Scholes**  
1981



**A.H. Baker**  
1982



**J.W. Atkinson**  
1983



**J.S. Duff**  
1984



**G.D. Bennett**  
1985



**R. Elder**  
1986



**J.W. Nesbit**  
1987



**S.A. Swift**  
1988



**E.S. Johnson**  
1989 & 1991



**W. Ridley**  
1990

## Men's Section Presidents (1991 - 2010)

Not all of the photographs were taken during their period in office

+ Sadly, John Graham passed away whilst in office



**J. Graham +**  
1991



**R.I. Shuttleworth**  
1992



**T. Lumley**  
1993



**R. Stafford**  
1994



**D. Gibbs**  
1995



**K. Griffiths**  
1996



**G. Goldie**  
1997



**A.M. Maclean**  
1998



**R.B. Baxter**  
1999



**P. Telfer**  
2000



**G.D. Bennett**  
2001



**A.O. Christie**  
2002



**K. Hunter**  
2003



**W.R. Liddle**  
2004



**E.W. Lowthian**  
2005



**H. Robson**  
2006



**J.T. Harrison**  
2007



**R.J. Varley**  
2008



**H. Robson**  
2009



**M. McDonnell**  
2010

## **Men's Section Presidents (2011 - 2023)**

**Not all of the photographs were taken during their period in office**



**J.D. Cowings  
2011**



**D.W. Kirk  
2012**



**D. Franks  
2013**



**H. Howell  
2014**



**P. Kilmister  
2015**



**M. Anderson  
2016**



**G. Lord  
2017**



**A.O. Christie  
2018**



**P.A. Dodds  
2019**



**R.J. Varley  
2020**



**R.D. Redhead  
2021**



**G. Lord  
2022**



**P. Kilmister  
2023**

### 10.3 Ladies' Section (1967 - 2023)

Year	President
1967	E. Pascoe
1968	E.A. Mankin
1969	D. Cuthbert
1970	J. Mole
1971-1972	E. Mills
1973	I. Richley
1974	D. Emery
1975	M. Stuart
1976	L. Barrons
1977	M. Cassie
1978	F.M. Bird
1979	E. Younger
1980	M. Little
1981	F. Owen
1982	L. Barrons
1983	M. Duff
1984	M. Myers
1985	K. Wright / K. Armstrong
1986	W.O. Carse
1987	N.F. Orton
1988	B. Johnston
1989	J. Cosby
1990	E. French
1991	M. Healy
1992	M.E.H. Nesbit
1993	J. Nichol
1994	F. Owen
1995	A. Gill
1996	M. Bryson
1997	I. Cassidy
1998	M. Healy
1999	C. Cobbing
2000	T. Wright
2001	E. Donkin
2002	N. Caldwell
2003	L. Telfer
2004	J. Trimble
2005	M. Cowan
2006	D.A. McDonnell
2007	D. Green
2008	M. Richardson
2009	M. Brown
2010	A. Rutter
2011	A. Brennan
2012	E. Gatenby
2013	J. Pringle
2014	R. Johnson
2015	E. Cowings
2016	S.A. Storey
2017	G. Stapylton
2018	R. Twizzel



**Year            President contd**

**2019            E.J. Ramsay  
2020            O. Driver / E.J. Ramsay  
2021            M. Kilmister  
2022            R. Rochester  
2023            S.A. Storey**

**Year            Secretary**

**1967            M. Woodhouse  
1968-1983      D. Emery  
1984            L. Barrons  
1985-1987      W.O. Carse  
1988-1991      M. Shuttleworth  
1992-1993      M. Bryson  
1994-1996      E. French  
1997-2000      N. Caldwell  
2001-2003      E. French  
2004-2006      E.D. Brown  
2007-2008      M. Brown  
2009            N. Caldwell  
2010-2011      E. Gatenby  
2012-2015      S.A. Storey  
2016-2018      E.J. Ramsay  
2019-2021      S.A. Storey  
2022-2023      P. Varley**

**Year            Treasurer**

**1967            D. Emery  
1968 - 1978      M.N. Pirnie  
1979 - 1981      L. Stockman  
1982 - 1983      W. O. Carse  
1984 - 1986      N.F. Orttton  
1987 - 1988      M. Scarlett  
1989 - 1990      E. Trimble  
1991 - 1993      L. Telfer  
1994 - 1995      J. Trimble  
1996 - 1997      C. Cobbing  
1998 - 1999      A. Baxter.**

**Year            Auditor**

**1967 - 1982      J. Carr  
1983            W.O. Carse  
1984 - 1985      L. Stockman  
1986            D. Bowyer  
1987 - 1997      N.F. Orttton  
1998 - 1999      W.O. Carse.**

## Ladies' Section Presidents (1969 - 1988)

Not all of the photographs were taken during their period in office

+ Sadly, Kath Wright passed away whilst in office



**D. Cuthbert**  
1969



**E. Mills**  
1971 & 1972



**J. Mole**  
1970



**L. Barrons**  
1976



**I. Richley**  
1973



**D. Emery**  
1974



**M. Stuart**  
1975



**M. Little**  
1980



**M. Cassie**  
1977



**F.M. Bird**  
1978



**E. Younger**  
1979



**M. Myers**  
1984



**F. Owen**  
1981



**L. Barrons**  
1982



**M. Duff**  
1983



**K. Wright +**  
1985



**K. Armstrong**  
1985

**W.O. Carse**  
1986

**N.F. Orton**  
1987



**B. Johnston**  
1988

## Ladies' Section Presidents (1989 - 2008)

Not all of the photographs were taken during their period in office



**J. Cosby**  
1989



**E. French**  
1990



**M. Healy**  
1991



**M.E.H. Nesbit**  
1992



**J. Nichol**  
1993



**F. Owen**  
1994



**A. Gill**  
1995



**M. Bryson**  
1996



**I. Cassidy**  
1997



**M. Healy**  
1998



**C. Cobbing**  
1999



**T. Wright**  
2000



**E. Donkin**  
2001



**N. Caldwell**  
2002



**L. Telfer**  
2003



**J. Trimble**  
2004



**M. Cowan**  
2005



**D.A. McDonnell**  
2006



**D. Green**  
2007



**M. Richardson**  
2008

## Ladies' Section Presidents (2009 - 2023)

Not all of the photographs were taken during their period in office

**R** Sadly, Olive Driver passed away shortly after her resignation



**M. Brown**  
2009



**A. Rutter**  
2010



**A. Brennan**  
2011



**E. Gatenby**  
2012



**J. Pringle**  
2013



**R. Johnson**  
2014



**E. Cowings**  
2015



**S.A. Storey**  
2016



**G. Stapylton**  
2017



**R. Twizell**  
2018



**E.J. Ramsay**  
2019 & 2020



**O. Driver R**  
2020



**M. Kilmister**  
2021



**R. Rochester**  
2022



**S.A. Storey**  
2023



**PBC Presidents**

**John Duff, 1984 and Marjorie Duff, 1983**



**PBC Presidents, 1994**

**Freda Owen and Ron Stafford**

# 11

## PBC Domestic Competition Results

### 11.1 Men's Section

Year	Welsh Memorial	
1932	J. Carr	
1933	T. Hall	
1934	R.L. Davison	
1935	A. Walker	
1936	C.F. Jameson	
1937 - 1938	T. Nichol	
1939	T. Fatkin	VE CUP
1940 - 1943	Not held	Handicap
1944	W.L. Hepple	
1945	W. Wilson	J. Brown
1946	J.M. Moorhead	W.L. Hepple
1947	J. Oliver	G.H. Batey
1948	W.L. Hepple	W.L. Hepple
1949	T. Fatkin	E. Forster
1950	W.L. Hepple	M. Johnstone
1951	K.B. Straughan	G.T. Meek
1952	W.V. Reed	W.V. Reed
1953	W. Coulson	W. Coulson
1954	R.F. Pascoe	J. Oliver
1955	R.F. Pascoe	A. Robinson
1956	A. Young	W.L. Hepple
1957	T. McPhee	W.L. Hepple
1958	W. Urwin	C.R. Ions
1959	T.W. Cuthbert	C.R. Ions
1960	T. McPhee	T. McPhee
1961	R.F. Pascoe	T.W. Cuthbert
1962	T. McPhee	R.F. Pascoe
1963	T.W. Cuthbert	C.F. Jameson
1964	T. McPhee	W. Mole
		VE CUP (awarded to Runner - up in Club Championship)
1965	M. Johnstone	E. Forster
1966	R.F. Pascoe	M. Johnstone
1967	R.F. Pascoe	W.S. Douglas
1968	M. Johnstone	T.S. Bruce
1969	R.F. Pascoe	T. McPhee
1970	T.W. Cuthbert	R.F. Pascoe
1971	W. Mole	W.L. Hepple
1972	W. Mole	R.F. Pascoe
1973	J.A. Main	E. Forster

<b>Year</b>	<b>Welsh Memorial contd</b>	<b>VE Cup contd</b>
1974	F.L. Kitto	W. Mole
1975	T.W. Cuthbert	T. Martin
1976	T. Martin	F.L. Kitto
1977	T.W. Cuthbert	H. Kinnear
1978	T.W. Cuthbert	A.H. Baker
1979	J.R. Linley	R. Elder
1980	T.W. Cuthbert	A. Young
1981	T. McPhee	M.A. Bennett
1982	T.W. Cuthbert	J. Stoker
1983	M.A. Bennett	J.S. Duff
1984	S. Rutherford	W. Ridley
1985	M.A. Bennett	F. Holt
1986	S. Rutherford	J. English
1987	M. Wearmouth	S. Rutherford
1988	S. Rutherford	M.A. Bennett
1989	M.A. Bennett	G. Leonard
1990	M.A. Bennett	M. Wearmouth
1991	M.A. Bennett	T. Lumley
1992	M.A. Bennett	T.W. Cuthbert
1993	M.A. Bennett	R. Stafford
1994	M.A. Bennett	S. Vine
1995	M.A. Bennett	K.D. Wood
1996	M.A. Bennett	P. Telfer
1997	M.A. Bennett	A. Harper
1998	W.R. Liddle	P. Telfer
1999	R. Stafford	R.A. Peckham
2000	T.A.W. Bell	W.R. Liddle
2001	W.R. Liddle	R. Stafford
2002	R.J. Varley	J.T. Harrison
2003	W.R. Liddle	R.A. Peckham
2004	J.S. Varley	H. Robson
2005	J.T. Harrison	W.R. Liddle
2006	R.J. Varley	T.N. Robson
2007	R.J. Varley	J.T. Harrison
2008	R.A. Peckham	H. Robson
2009	R.J. Varley	R.A. Peckham
2010	R.J. Varley	M.L. Brennan
2011	D.C. Crozier	W.R. Liddle
2012	M.L. Brennan	D.C. Crozier
2013	D.W. Morrison	J. Roberts
2014	R. Horsfall	M.L. Brennan
2015	D.W. Morrison	J. Taylor.
2016	D.W. Morrison	R.J. Varley
2017	R.J. Varley	A.O. Christie
2018	W. Howard	W.R. Liddle
2019	R.J. Varley	P.A. Dodds
2020	Not held - Coronavirus (Covid-19)	
2021	S. Edwards	G. Lord
2022	D. Burbeck	W. Howard
2023	W. Howard	I. Cahill

<b>Year</b>	<b>2-Bowl Handicap</b>
1934	W. Bissett
1935	J.M. Moorhead
1936 - 1937	W.L. Hepple
1938	W. Barrons
1939	T. Nichol
1940 - 1945	Not held
1946	W.V. Reed
1947 - 1956	-
1957	C.R. Ions
1958	W.L. Hepple
1959	S. Stoddart
1960	E. Forster
1961	A. Young
1962	T.W. Cuthbert

<b>Year</b>	<b>P.L. Lloyd : 2-Bowl</b>
1963	T. McPhee
1964	T.W. Cuthbert
1965	E. Forster
1966	A. Robinson
1967	W.S. Douglas
1968	Competition not completed
1969 - 1970	W. Mole
1971	C. Cassie
1972	T.W. Cuthbert
1973 - 1974	T. McPhee
1975	A. Young
1976	J. English
1977 - 1980	T. McPhee
1981	T.W. Cuthbert
1982	S. Rutherford
1983	M. Wearmouth
1984	S. Rutherford
1985	M. Wearmouth
1986 - 1987	S. Rutherford
1988	T.W. Cuthbert
1989	M.A. Bennett
1990	J.S. Duff
1991	M.A. Bennett
1992	P. Telfer
1993	M.A. Bennett
1994	T. Lumley
1995	K.D. Wood
1996	J.T. Harrison
1997	D.T. Edwards
1998	P. Telfer
1999	G.D. Bennett
2000	W.R. Liddle
2001	R.J. Varley
2002	R.J. Varley
2003	R.A. Peckham
2004	D. Hudson



**Year P.L. Lloyd : 2-Bowl contd**

2005	J.T. Harrison
2006	W.R. Liddle
2007	P. Telfer
2008	R.J. Varley
2009	M.L. Brennan
2010	R.J. Varley
2011	D. C. Crozier
2012	D.W. Morrison
2013	J. Roberts
2014	M.L. Brennan
2015	D.W. Morrison
2016	R.J. Varley
2017	J. Taylor
2018	P. Dodds
2019	R.J. Varley
2020	Not held - Coronavirus (Covid-19)
2021	W. Howard
2022	D. Burbeck
2023	W. Howard

**Year W. Milne 4-Bowl Challenge**

1934	J.H. Allison (won the above trophy outright in 1934, and it was replaced with a silver rose bowl in 1935).
------	--

**Year W. Milne 4- Bowl Handicap**

1935	W. Wilson
1936	T. Nichol
1937	R. Yates
1938	J. Oliver
1939	C.F. Jameson
1940 - 1944	Not held
1945	W. Urwin
1946	M. Johnstone
1947	A. Summersby
1948	W. Coulson
1949	J.H. Hall
1950	E. Fulton
1951	A. Robinson
1952	T. Strangeways
1953	E. Dodds
1954 - 1955	R.F. Pascoe
1956	W. Tait
1957	J.R. Lee
1958	T. McPhee
1959	E. Moxon
1960	W.L. Hepple
1961	T. McPhee
1962	R.W. Preston
1963 - 1965	T. McPhee
1966	G. Longstaff
1967	T. McPhee
1968	T.S. Bruce

<b>Year</b>	<b>W. Milne 4- Bowl Handicap contd</b>
1969	W. Mole
1970	W. Mole
1971	B.D.W Wright
1972	T. McPhee
1973 - 1974	T.W. Cuthbert
1975	J.A. Main
1976	T. McPhee
1977 - 1978	T.W. Cuthbert
1979	A. Young
1980	J. English
1981	M. Wearmouth
1982	J. Carr
1983	S.A. Swift
1984	S. Rutherford
1985	F. Holt
1986	T.W. Cuthbert
1987 - 1988	S. Rutherford
1989	J.S. Duff
1990	M.A. Bennett
1991	R.I. Shuttleworth
1992	M.A. Bennett
1993	P. Telfer
1994	H. Robson
1995	K.D. Wood
1996	H. Robson
1997	W.R. Liddle
1998	G.D. Bennett
1999	J.T. Harrison
2000	G.D. Bennett
2001	H. Robson
2002	A. Wilson
2003	R.J. Varley
2004	D. Hudson
2005	A. Ridley
2006	R.J. Varley
2007	R.J. Varley
2008	R. Stafford
2009	D.W. Kirk
2010	M.L. Brennan
2011	A. Ridley
2012	M.L. Brennan
2013	D.W. Morrison
2014	P.A. Dodds
2015	W. Howard
2016	D.C. Crozier
2017	R. Symonds
2018	A..O. Christie
2019	D. Burbeck
2020	Not held - Coronavirus (Covid-19)
2021	P.A. Dodds
2022	W. Howard
2023	I. Cahill

<b>Year</b>	<b>4-Bowl Over 60 Handicap</b>
1957	E. Forster
1958	J.W. Weightman
1959	E.P. Bell
1960	R.W. Preston
1961	R. Selby
1962 - 1963	A. Ridley
1964	J.W. Weightman
1965	Not completed
1966	R.F. Pascoe
1967	W.S. Douglas
1968	Not completed
1969	T.S. Bruce
1970	W. Mole
1971	T. Mills
1972	W. Mole
1973	J.A. Main
1974	F.L. Kitto
1975	F.E. Loughton
1976	J. Carr
1977	A. Young
1978	W. Middlemiss
1979	D.L. Walker
1980	E. Forster
1981 - 1983	J.S. Duff
1984	J.W. Atkinson
1985	S. Wright
1986	S. Rutherford
1987	B. Armstrong
1988	R. Stafford
1989 - 1990	J.S. Duff
1991	T. Nichol
1992	H. Davis
1993	S. Vine
1994	P. Telfer
1995	W. Bell
1996	D.T. Edwards
1997 - 1998	R.A. Peckham
1999	R. Stafford
2000	J.T. Harrison
2001	D. Hudson
2002	J.S. Varley
2003	J.T. Harrison
2004	J.S. Varley
2005	J.T. Harrison
2006	M.L. Brennan
2007	R.J. Varley

<b>Year</b>	<b>John English 3-Bowl Handicap</b>
2008	R.J. Varley
2009	J.D. Cowings
2010	D.W. Morrison
2011	D.W. Morrison
2012	J.D. Cowings
2013	D.W. Morrison
2014	R. Horsfall
2015	R. Horsfall
2016	R. Horsfall
2017	R. Symonds
2018	W. Howard
2019	D. Burbeck
2020	Not held - Coronavirus (Covid-19)
2021	W. Howard
2022	W. Howard
2023	I. Cahill

<b>Year</b>	<b>William Wilson Memorial Trophies : Pairs</b>
1948	J. Robson & E. Hopkinson
1949	W.V. Reed & E. Hopkinson
1950	W.R. Yates & T. Wintrip
1951	R.F. Pascoe & W.V. Reed
1952	J.A. Ions & M. Johnstone
1953	W.L. Hepple & W. Tait
1954	J. Oliver & H.S. Robinson
1955	C.F. Jameson & A. Ridley
1956	J. Carr & J. Wilson
1957	A. Attwater & A. Oates
1958	J. Carr & R. Eayrs
1959	W.S. Douglas & E.P. Bell
1960	W.L. Hepple & J. Wallace
1961	A. Young & J. Wood
1962	W. Mole & G.C. Nicholson
1963	J. Loughton & G. Cresswell
1964	R. Selby & E. Forster
1965	G. Latham & J. Parsons
1966	W.S. Douglas & E. Forster
1967	J.M. Moorhead & T.S. Bruce
1968	W. Wilson & J. Richley
1969	T. McPhee & E. Moxon
1970	J. Carr & G. Berry
1971	W. Mole & J.A. Milne
1972	R.F. Pascoe & T.S. Bruce
1973	J.A. Main & L.R. Mankin
1974	A.H. Baker & A. Howes
1975	A. Young & B.D.W. Wright
1976	A. Young & E. Forster
1977	J.H. Lees & H. Kinnear
1978	J.A. Main & E. Forster
1979	E. Scholes & J. English
1980	T.W. Cuthbert & M.A. Bennett
1981	M. Wearmouth & J.W. Crabb
1982	J. English & R.I. Shuttleworth

Year	William Wilson Memorial Trophies : Pairs contd
1983	D.L. Walker & M.A. Bennett
1984	J. Lunn & J. English
1985	H. Hill & E.S. Johnson
1986	E.S. Johnson & R.I. Shuttleworth
1987	J.W. Nesbit & J. Lunn
1988	W. Robinson & T. Lumley
1989	J. English & G. Attwater
1990	G. Bowmer & L. Crofts
1991	T. Lumley & G. Warner
1992	J.W. Atkinson & G.D. Bennett
1993	T.W. Cuthbert & A. Turner
1994	K.D. Wood & L. Crofts
1995	W. Robinson & W.R. Liddle
1996	J.T. Harrison & S.A. Swift
1997	J.T. Harrison & G. Skinner
1998	K. Hunter & A. Harper
1999	J.S. Varley & A. Harper
2000	A.O. Christie & T.A.W. Bell
2001	K. Hunter & K. Griffiths
2002	G. Pringle & J. Lunn
2003	J.T. Harrison & A. Wilson
2004	W.R. Liddle & E.W. Lowthian
2005	J.T. Harrison & N. Buchanan
2006	J. Burn & D. Carr
2007	R.J. Varley & D. Carr
2008	Cancelled - rain
2009	J.S. Varley & J. Waller
2010	D.W. Morrison & D.G. Kennerley
2011	Cancelled - rain
2012	Cancelled - rain
2013	Cancelled - rain
2014 - 2018	Not held
2019	R.J. Varley & D. Burbeck
2020	Not held - Coronavirus (Covid-19)
2021	Not held
2022	D. Burbeck & J. Slater
2023	P.A. Dodds & J. Slater

Year	Wm M. Straughan Memorial Trophy
1957	C.R. Ions
1958	E. Forster
1959 - 1960	G. Latham
1961	T.W. Cuthbert
1962	G. Latham
1963	W. Urwin
1964	H. Emery
1965	E. Forster
1966	A. Robinson
1967	C.F. Jameson
1968	J. Irvine

<b>Year</b>	<b>Wm M. Straughan Memorial Trophy contd</b>
1969	W. Mole
1970 - 1971	Not held -
1972 - 1973	W. Mole
1974	F.L. Kitto
1975	J. English
1976	J.H. Lees
1977	J.A. Main
1978	T. McPhee
1979	J.S. Duff
1980	T. McPhee
1981	J.S. Duff
1982	J.W. Nesbit
1983	J. Carr
1984	S. Rutherford
1985	R. Potts
1986 - 1987	J.S. Duff
1988	T. Lumley
1989	R. Stafford
1990	R. Stafford / P. Cordingley
1991	J.S. Duff
1992	R. Stafford
1993	K.D. Wood
1994	P. Telfer
1995	R. Stafford
1996	K.D. Wood
1997	R.A. Peckham
1998 - 1999	P. Telfer
2000	R. Stafford
2001	J.S. Varley
2002	R. Stafford
2003 - 2005	P. Telfer
2006	M. L. Brennan
2007	K. Hunter
2008	A.O. Christie
2009 - 2010	P. Telfer
2011	B. Ashford
2012	P. Telfer
2013	J.S. Varley
2014	P. Kilmister
2015	P. Wilson
2016	P. Telfer
2017	R. Pearson
2018	W. Howard
2019	L. Collins
2020	Not held - Coronavirus (Covid-19)
2021	P. Wilson
2022 - 2023	D. Burbeck

<b>Year</b>	<b>Angora Trophy</b>
1992	E. Scholes
1993	D. Marshall
1994	K. Griffiths
1995	A. Harper
1996	G. Cassidy
1997	G.M. Wilcock
1998 - 2001	Not held
2002	B.C. Johnson
2003	Not held
2004	J. Lunn
2005	D. Noble
2006	K. Hunter
2007	G. Lowe
2008	D. Carr
2009	J. Gatenby
2010	D.W. Morrison
2011	G. Shepley
2012	P. Kilmister
2013	P.A. Wilson
2014	Not completed
2015	W. Howard
2016	D. Redhead
2017	M. O'Rourke
2018	A. Russell
2019	D. Burbeck
2020	Not held - Coronavirus (Covid-19)
2021	G. Lord
2022	M. Anderson
2023	C. Potts

**Year                    Blue Series - Short Jack : Singles**

2022	G. Burnip
2023	C. Asmussen

**Year                    Blue Series - Short Jack : Pairs**

2022	G. Daunt & B. Foreman
2023	C. Asmussen & D. Crozier

**Year                    Blue Series - Short Jack Matches**

2022	A. Atkinson
2023	P. Ryder



**Annual Prize Presentation : Men's Section Trophies, 1976**



**Annual Prize Presentation : Men's Section Trophies, 2011**

## **11.2 Ladies' Section**

<b>Year</b>	<b>2-Bowl</b>	
<b>1972</b>	<b>L. Barrons</b>	
<b>1973</b>	<b>M. Little</b>	
<b>1974</b>	<b>J. English</b>	<b>Elizabeth Pascoe</b>
<b>1975</b>	<b>E. Mills</b>	<b>Memorial 4-Bowl</b>
<b>1976</b>	<b>M. Cassie</b>	
<b>1977</b>	<b>H. Bell</b>	<b>A.O. MacLeod</b>
<b>1978</b>	<b>M. Little</b>	<b>M. Little</b>
<b>1979</b>	<b>M. Shuttleworth</b>	<b>J. Carmichael</b>
<b>1980</b>	<b>D. Emery</b>	<b>F. Owen</b>
<b>1981</b>	<b>M. Shuttleworth</b>	<b>M. Shuttleworth</b>



<b>Year</b>	<b>2-Bowl contd</b>	<b>Elizabeth Pascoe Memorial 4-Bowl contd</b>
1982	J. Graham	J. Graham
1983	D. Emery	M. Shuttleworth
1984	B. Johnston	M. Cassie
1985	J. Graham	J. Graham
1986	M. Little	J. Graham
1987	N.F. Ortton	B. Johnston
1988	M. Little	I. Fletcher
1989	A. Gill	J. Graham
1990	B. Johnston	M. Shuttleworth
1991	L. Telfer	J. Graham
1992	A. Gill	M. Shuttleworth
1993	M. Shuttleworth	M. Shuttleworth
1994	L. Telfer	M. Shuttleworth
1995	J. Nichol	M. Shuttleworth
1996	T. Wright	E. Newton
1997	T. Wright	M. Tailford
1998	M. Shuttleworth	M. Shuttleworth
1999	D. Walwyn-James	M. Shuttleworth
2000	M.E.H. Nesbit	M. Shuttleworth
2001	E. French	M. Shuttleworth
2002	J. Nichol	M. Shuttleworth
2003	N. Caldwell	L. Telfer
2004	L. Telfer	N. Caldwell
2005	J. Nichol	M.E.H. Nesbit
2006	M. Cowan	L. Telfer
2007	N. Caldwell	J. Nixon
2008	M. Cowan	E. Emmerson
2009	E. Emmerson	M. Catchpole
2010	E. Emmerson	M. Cowan
2011	S.A. Storey	E. Emmerson
2012	P. Varley	M. Cowan
2013	M. Cowan	E. Emmerson
2014	J. Nixon	J. Nixon
2015	P. Varley	E. Emmerson
2016	E. Emmerson	S. O'Rourke
2017	I. Eden	G. Stapylton
2018	L. Marsh	G. Stapylton
2019	J. Nixon	E. Emmerson
2020	Not held - Coronavirus (Covid-19)	
2021	E. Emmerson	A. Pearson
2022	A. Pearson	E. Emmerson
2023	A. Pearson	A. Pearson

<b>Year</b>	<b>Lilian Loughton Cup, 3-Bowl</b>	<b>Nan MacLeod Salver</b>
1982	D. Emery	M. Little
1983	M. Shuttleworth	M. Cassie
1984	M. Shuttleworth	M. Little
1985	N. Rutherford	M. Duff
1986	M. Little	W.O. Carse
1987	T. Wright	L. Stockman
1988	F. Owen	M. Duff

Year	Lilian Loughton Cup, 3-Bowl contd	Nan MacLeod Salver contd
1989 - 1990	M. Shuttleworth	M. Little
1991	M. Shuttleworth	T. Wright
1992	A. Gill	F. Owen
1993	M. Shuttleworth	M. Myers
1994	T. Wright	M. Little
1995	A. Gill	N.F. Ortton
1996	L. Telfer	A. Baxter / B. Stafford
1997	E. French	M. Lowthian
1998	T. Wright	B. Stafford
1999	E. Donkin	B. Johnston
2000	L. Telfer	M. Catchpole
2001	M. Shuttleworth	D. Green
2002	J. Nichol	N. Caldwell
2003	M.E.H. Nesbit	R. Boland
2004	N. Caldwell	E. Emmerson
2005	M. Cowan	C. Cobbing
2006	M. Cowan	A. Brennan
2007	E. Emmerson	E. Trimble
2008	J. Nixon	S. Smith
2009	J. Nichol	S. Smith
2010	M. Cowan	M. Brown
2011	J. Nixon	J. Howell
2012	N. Caldwell	J. Pringle
2013	E. Emmerson	A. Graham
2014	G. Stapyhton	J. Barras
2015	G. Stapyhton	N. Caldwell
2016	J. Nixon	O. Driver
2017	E. Emmerson	A. Pearson
2018	E. Emmerson	M. Dodd
2019	Cancelled - rain	O. Driver
2020	Not held - Coronavirus (Covid-19)	
2021	A. Pearson	I. Young
2022	M. Cowan	L. Marsh
2023	A. Pearson	A. Pearson

Year	Pairs' Trophies
1980	F. Owen & A.O. MacLeod
1981	M. Shuttleworth & H. Bell
1982	J. Graham & M. Shuttleworth
1983	M. Baker & J. Carmichael
1984	M. Little & N. Rutherford
1985	M. Shuttleworth & D.A. Johnson
1986	M. Little & M. Scarlett
1987	M. Duff & M. Myers
1988	M. Shuttleworth & B. Johnston
1989	N.F. Ortton & M. Duff
1990	N. Rutherford & M. Shuttleworth
1991	L. Telfer & M. Scarlett
1992	D. Lumley & F. Owen
1993	E. French & M. Shuttleworth
1994	L. Telfer & V. Lonsdale

<b>Year</b>	<b>Pairs' Trophies contd</b>
1995	M. Little & F. Owen
1996	J. Nichol & M. Tailford
1997	N. Rutherford & M.E.H. Nesbit
1998	T. Wright & C. Cobbing
1999	M.E.H. Nesbit & M. Cassie
2000	C. Cobbing & E. Donkin
2001	M. Bryson & C. Cobbing
2002	L. Telfer & M. Scarlett
2003	E. Emmerson & L. Porritt
2004	M.E.H. Nesbit & J.Crosby
2005	E. Emmerson & J. Marshall
2006	A. Brennan & M. Brown
2007	E. Emmerson & J. Trimble
2008	N. Caldwell & A. Rutter
2009	E. French & M. Robinson
2010	L. Telfer & W. Olds
2011	M. Catchpole & E. Trimble
2012	W. Olds & J. Nixon
2013	M. Mannings & D. Walwyn-James
2014	S.A Storey & M. Dodds
2015	P. Haylock & M. Catchpole
2016	Abandoned due to heavy rain
2017	M. Kilmister & S.A. Storey
2018	E. French & M. Robinson
2019	A. Brennan & A. Graham
2020	Not held - Coronavirus (Covid-19)
2021	Not held
2022	M. Kilmister & L. Bolam
2023	I. Young & A. Shipley

<b>Year</b>	<b>Joyce Carmichael Memorial Cup : Triples</b>
1986	B. Stafford, M. Myers & W.O. Carse
1987	B. Johnston, E. Scott & F. Owen
1988	M.E.H. Nesbit, E. French & N. Rutherford
1989	M. Davis, M. Healy & M. Shuttleworth
1990	L. Stockman, F. Jeffs & M. Healy
1991	M. Williamson, A. Gill & J. Nichol
1992	J. Cosby, B. Johnston & J. Nichol
1993	E. French, V. Lonsdale & L. Telfer
1994	F. Owen, A. Gill & E. Newton
1995	T. Wright, M. Williamson & W.O. Carse
1996	J. Nichol, M. Lowthian & I. Cassidy
1997	T. Wright, N. Orton & N. Rutherford
1998	F. Owen, A. Gill & E. Donkin
1999	E. French, M. Healy & F. Owen
2000	E. French, B. Grieve & C. Cobbing
2001	M. Catchpole, E. Emmerson & E. Shuttleworth
2002	M. Catchpole, M. Lowthian & F. Owen
2003	E. Shuttleworth, M. Williamson & L. Telfer
2004	M. Williamson, N. Caldwell & J. Howell
2005	M. Richardson, J. Jackson & E. Emmerson
2006	N. Caldwell, M.E.H. Nesbit & A. Rutter
2007	M. Brown, M. Bryson & L. Telfer

<b>Year</b>	<b>Joyce Carmichael Memorial Cup : Triples contd</b>
2008	E. Emmerson, J. Marshall & E. Trimble
2009	D.A. McDonnell, E. Cowings & M. Robinson
2010	M. Brown, W. Olds & N. Caldwell
2011	P. Haylock, A. Rutter & R. Johnson
2012	E. French, W. Olds & J. Nixon
2013	I. Young, D. Walwyn-James & M. Robinson
2014	M. Bryson, M. Cowan & R. Twizell
2015	C. Davison, P. Haylock & J. Nixon
2016	J. Dineen, J. Nichol & J. Nixon
2017	M. Richardson, E. Shuttleworth & M. Catchpole
2018	O. Driver, C. Davison & A. Graham
2019	Cancelled - rain
2020	Not held - Coronavirus (Covid-19)
2021	Not held
2022	E. Emmerson, M. Kilmister & M. Turner
2023	E. Leiper & A. Pearson

<b>Year</b>	<b>Rainbow Trophy</b>
-------------	-----------------------

1997	B. Stafford
1998	M. Myers
1999	E. Emmerson
2000	J. Smith
2001	M. Catchpole
2002	J. Trimble
2003	M. Cowan
2004	I. Cassidy
2005	E. Donkin
2006	S.M. Ridley
2007	M. Richardson
2008	C. Donachey
2009	M. Robinson
2010	M. Bryson
2011	Cancelled - rain
2012	M.E.H. Nesbit
2013	P. Haylock
2014	W. Olds
2015	J. Dineen
2016	O. Driver
2017	J. Barras
2018	J. Nichol
2019	Cancelled - rain
2020	Not held - Coronavirus (Covid-19)
2021	Not held
2022	W. Tate
2023	Not held

<b>Year</b>	<b>Mary Little Memorial, 1997</b>
-------------	-----------------------------------

1998	W.O. Carse & M. Myers
1999	F. Owen
2000	Not held - Coronavirus (Covid-19)
2001	J. Cosby
2002	F. Owen
2003	Mr G. Webb

**Year Mary Little Memorial, 1997 contd**

<b>2004</b>	<b>M.E.H. Nesbit</b>
<b>2005</b>	<b>No award made</b>
<b>2006</b>	<b>M. Taylor</b>
<b>2007</b>	<b>D. Walwyn-James</b>
<b>2008</b>	<b>D. Green</b>
<b>2009</b>	<b>D. Walwyn-James</b>
<b>2010</b>	<b>No award made</b>
<b>2011</b>	<b>L. Telfer</b>
<b>2012</b>	<b>M.E.H. Nesbit</b>
<b>2013</b>	<b>M. Bryson</b>
<b>2014</b>	<b>M. Bryson</b>
<b>2015</b>	<b>L. Telfer</b>
<b>2016</b>	<b>C. Davison</b>
<b>2017</b>	<b>J. Pringle</b>
<b>2018</b>	<b>G. Stapylton</b>
<b>2019</b>	<b>L. Telfer</b>
<b>2020</b>	<b>Not held - Coronavirus (Covid-19)</b>
<b>2021</b>	<b>No award made</b>
<b>2022</b>	<b>No award made</b>
<b>2023</b>	<b>I. Eden</b>

**Year Blue Series - Short Jack Matches**

<b>2022</b>	<b>M. Sutherland</b>
<b>2023</b>	<b>J. Brady</b>



**Annual Prize Presentation : Ladies' Section Trophies, 2011**

## 11.3 Mixed Competitions

<b>Year</b>	<b>Joint Presidents' Day</b>
2004	K. Harrisin, Mesdames M. Lowthian, J. Nichol & M. Williamson
2005	Mrs J. Nichol, J. Burn, E. Caldwell & Mrs J. Marshall
2006	A.O. Christie, Mrs D. Walwyn-James, A. Ridley & Mrs B. Johnston
2007	P. Telfer, A. Ridley, Mrs A. Brennan & J.M. Gill
2008	Cancelled - rain
2009	P. Telfer, Mrs R. Smith, J.Waller & Mrs A. Brennan
2010	P. Telfer, Mesdames H. Furniss, S.A. Storey & D.A. McDonnell
2011	A. Mahmood, Mesdames J. Howell & M. Richardson, R.J. Varley
2012	J. Waller, E. Scholes, Mesdames E. Emerson & G. Staplyton
2013	Mesdames E. Cowings & G. Staplyton, E. Scholes & J. Waller
2014	D.C. Crozier, Mesdames C. Donachey & J. Nichol, J.D Cowings
2015	A. Barnfather, W. Howard, Mesdames P. Haylock & L. Telfer.
2016	Mesdames M. Brunson, D. Walwyn-James & C. Davison, D. Franks
2017	J. Driver, Mesdames, D. Taylor, M. Richardson & P. Telfer
2018	Mesdames M. Dodd, A. Pearson and R. Rochester & A.O. Christie
2019	Postponed on two occasions - rain
2020	Not held - Coronavirus (Covid 19)
2021	Not held
2022	R. Pearson, M. Anderson, F. Woodhouse & M. Pringle
2023	Postponed on three occasions - rain

<b>Year</b>	<b>Telfer Open Pairs</b>
2005	J. Varley & Mrs D. Walwyn-James
2006	R. Stafford & E. Scholes
2007	Mesdames M. Catchpole & M.E.H. Nesbit
2008	Mesdames M. Catchpole & M.E.H. Nesbit
2009	Not held
2010	P. Telfer & Mrs L. Telfer
2011	Cancelled - rain
2012	P. Telfer & Mrs L. Telfer
2013	M. Mc Donnell & Mrs D.A McDonnell
2014	R.J. Varley & Mrs P. Varley.
2015	Ms S.A. Storey & Mrs G. Staplyton
2016	Mrs P. Varley & R.J. Varley
2017	D. Thompson & Miss J. Barras
2018	P. Dodds & Mrs M. Dodds
2019	M. Cowan & A.O.Christie

<b>Year</b>	<b>Percy &amp; Lorna Telfer Trophy</b>
2022	D. Burbeck & Mrs L. Marsh
2023	D. Burbeck & Mrs G. Staplyton

<b>Year</b>	<b>Harry Emery Memorial, 1974 : Pairs</b>
1975	Mrs E. Roper & R.F. Pascoe
1976	Mrs M. Peterson & A. Young
1977	Mrs H. Bell & R.F. Pascoe
1978	Mrs M. Little & R. Elder
1979	Mrs F.M. Bird & J.W. Atkinson
1980	Mrs M. Shuttleworth & J. English
1981	Mrs J. Carmichael & M. Wearmouth
1982	Mrs D. Emery & J. English
1983	Mrs M. Shuttleworth & J.W. Nesbit
1984	Mrs L. Barrons & M.A. Bennett
1985	Mrs J. Graham & A.H. Baker
1986	Mrs D. Emery & M. Wearmouth
1987	Mrs B. Johnston & T. Nichol
1988	Mrs D. Emery & L. Crofts
1989	Mrs F. Owen & J. English
1990	Mrs A. Gill & D. Boland
1991	Mrs F. Owen & G. Attwater
1992	Mrs D. Lumley & T. Lumley
1993	Mrs L. Barrons & J. English
1994	Mrs M. Little & C. Walters
1995	Mrs N. Rutherford & E.W. Lowthian
1996	Mrs J. Nichol & D. Gibb
1997	Miss E. Trimble & W.R. Liddle
1998	Mrs C. Cobbing & E. Scholes
1999	Mrs J. Nichol & J.S. Varley
2000	Mrs M. Lowthian & B.C Johnson
2001	Mrs J. Smith & P. Cordingley
2002	Mrs L. Telfer & J.W. Nesbit
2003	Mesdames M.E.H. Nesbit & D.A. McDonnell
2004	Mrs H. Furniss & E. Scholes
2005	Mrs J. Smith & E. Marshall
2006	Mrs P. Varley & P. Telfer
2007	Mrs J. Marshall & R.J. Varley.
2008	Mrs J. Nichol & M. McDonnell
2009	Mrs L. Telfer & R. Rutter

<b>Year</b>	<b>Emery / Wright Mixed Triples</b>
2010	Mesdames L. Telfer & H. Furniss, R. Rutter
2011	Cancelled - rain
2012	Cancelled - rain.

<b>Year</b>	<b>John Nesbit Trophy : Pairs</b>
1987	G.D. Bennett & T. McPhee
1988	S. Wright & A.M. Maclean
1989	A.S. Swift & J.W. Atkinson
1990	R.B. Baxter & W.R. Liddle
1991	W.R. Liddle & C. Taylor
1992	Mrs M. Little & R.B. Baxter
1993	Mrs D. Crofts & G. Bowmer
1994	P. Telfer & E.W. Lowthian

**Year            John Nesbit Trophy : Pairs contd**

**1995            Cancelled**  
**1996            Mrs A. Gill & T. Lumley**  
**1997            Cancelled**  
**1998            Mesdames M. Catchpole & L. Telfer**  
**1999            R. Lyon & L. Crofts**  
**2000            G. Warner & Mrs T. Wright**

**Year            John Nesbit Trophy : Triples**

**1995            Mrs D. Crofts, D.T. Edwards & Mrs G. Jordan**  
**1997            P. Cordingley, Mesdames F. Owen & M. Catchpole.**

**Year            Brian & Kathleen Armstrong Memorial Trophy :  
Ladies' Tens v. Men's Tens**

**2002 - 2005    Men's Section**  
**2006            Not held**  
**2007 - 2008    Ladies' Section**  
**2009 - 2013    Men's Section**  
**2014            Ladies' Section**  
**2015            Men's Section**  
**2016            Cancelled - rain**  
**2017 - 2019    Men's Section**  
**2020            Not held - Coronavirus (Covid-19)**  
**2021            Not held**  
**2022 - 2023    Men's Section**

**Year            Ron Elder Trophies : Presidents' Mixed Triples**

**1985            A.H. Baker, T. Nichol & Mrs M. Shuttleworth**  
**1986            Mrs K. Armstrong, G. Attwater & J. English**  
**1987            S. Wright, Mrs E. Younger & J. Graham**  
**1988            N. French, Mrs M.E.H. Nesbit & S. Rutherford**  
**1989            M.A. Bennett, Mrs M. Healy & J.W. Atkinson**  
**1990            M.A. Bennett, Mesdames M. Cassie & D.A. Johnson**  
**1991            Mesdames E. French & M. Tailford, S. Wright**  
**1992            Mrs J. Graham, P. Cordingley & J.T. Harrison**  
**1993            R. Stafford, Mrs M. Lowthian & J.W. Atkinson**  
**1994            J.T. Harrison, Mesdames N. Rutherford & N. Caldwell**  
**1995            M. Edison, Mrs B. Stafford & Miss J. Trimble**  
**1996            Mrs M. Shuttleworth, C. Taylor & N. French**  
**1997            A.M. Maclean, J.T. Harrison & Miss E. Trimble**  
**1998            Mesdames N. Caldwell & T. Wright, D. Gibb**  
**1999            L. Crofts, Mrs M. Shuttleworth & E. Watson**  
**2000            Mesdames J. Nichol & M. Goldie, A. Wilson**  
**2001            Mesdames D. Crofts & E.D. Brown, E.W. Lowthian**  
**2002            Mesdames N. Caldwell & M. Tailford, J.S. Varley**  
**2003            R. Brown, Mesdames M. Tailford & F. McDonald**  
**2004            J.T. Harrison, D. Downing & Mrs H. Waddell**  
**2005            Mrs E. Emmerson, K. Griffiths & Mrs M. Brown**  
**2006            Mrs N. Caldwell, D. Carr & Mrs A. Rutter**  
**2007            P. Telfer, Mrs E. French & F. Marshall**  
**2008            R.J. Varley, Mrs D. Green & E.W. Lowthian**



<b>Year</b>	<b>Ron Elder Trophies : Presidents' Mixed Triples contd</b>
2009	J.D. Cowings, J. Gatenby & Mrs M. Catchpole
2010	P. Telfer, Mesdames M. Anderson & J. Dineen
2011	Mesdames A. Rutter, W. Olds & C. Davison
2012	Mesdames J. Nixon & M. Catchpole, D. Thompson
2013	Mesdames D.A. Mc Donnell, M. Dodds & P. Varley
2014	Mrs S.M. Ridley, A.O. Christie & Mrs J. Nichol
2015	Cancelled - rain
2016	Mesdames I. Eden & M. Cowan, G. Lord
2017	Mesdames E. Emerson & M. Kilmister, R.D. Redhead
2018 - 2023	Not held



**Trophies : Presidents' Mixed Triples, 2012**

<b>Year</b>	<b>Stan Wright Trophy : Rinks</b>
1992	Mrs E. Walters, C. Walters, Mrs L. Telfer & R.B. Baxter
1993	Mesdames E. Newton & E. Walters, R.B Baxter & J.S. Duff
1994	Mesdames T. Wright, D. Crofts & M. Tailford, R. Stafford
1995	Mrs M. Lowthian, D. Gibb, Mrs E. Emmerson & T. Lumley
1996	Mesdames M. Bryson & E. Emmerson, T. Lumley & Mrs M. Scarlett
1997	Mesdames E. French & B. Grieve, R. Stafford
1998	Mesdames N. Caldwell & E. Emmerson, A. Harper
1999	Mrs M. Bryson, A. Reid & Mrs N. Rutherford
2000	Mrs L. Telfer, J.S. Varley, Mesdames C. Cobbing & J. Trimble
2001	R. Donkin, Mesdames E. French, H. Furniss & J. Marshall
2002	R.B. Baxter, Mrs M. Catchpole, G. Goldie & Mrs M. Healy
2003	K. Harrison, Mesdames M. Lowthian, J. Nichol & M. Williamson
2004	Mesdames E. Emmerson & D. Walwyn-James, G. Goldie & Mrs M. Healy

**Year Stan Wright Trophy : Rinks contd**

**2005 Mesdames M.E.H. Nesbit & B. Stafford, C. Bryson &  
Mrs A. Baxter**

**2006 Mrs M. Catchpole, E. Scholes, J.S. Varley & Mrs M. Brown**

**Year Stan Wright Trophy : Triples**

**2007 F. Marshall, J. Waller & Mrs M. Williamson**

**2008 F. Marshall, Mesdames A. Brennan & M. Richardson**

**2009 Mrs R. Johnson, T.N. Robson & D.G. Kennerley**



**Winners of the Ron Elder Presidents' Mixed Triples Competition, 1986  
(l - r) : John English, Kathleen Armstrong and Gerald Attwater**

# 12

## PBC Membership

In most cases, and for conciseness, only the initials of forenames or familiar names of members are shown in photographs and the text. Their names are listed below together with those of the domestic competition winners in Section 11.

Altogether, there are 376 members' names recorded in this narrative, 143 ladies and 233 men. However, in some of the earlier men's group photographs it has not been possible to obtain their names.

### Ladies' Section

Anderson, R. (Rosalynde)  
Armstrong, K. (Kathleen)  
Baker, M. (Margaret)  
Barclay, M. (Miriam)  
Barras, J. (Jean)  
Barras, S. (Susan)  
Barrons, L. (Lilian)  
Baxter, A. (Audrey)  
Bell, H. (Hilda)  
Bird, F.M. (Marjory)  
Boland, R. (Rosemary)  
Bowyer, D. (Dorothy)  
Brady, J. (Judith)  
Brennan, A. (Adrienne)  
Brown, E.D. (Doreen)  
Brown, E. (Betty)  
Brown, M. (Peg)  
Bryson, M. (Margaret)  
Caldwell, N. (Nancy)  
Carr, O.M. (Olive)  
Carmichael, J. (Joyce)  
Carse, W.O. (Ora)  
Cassidy, I. (Irene)  
Cassie, M. (Marjory)  
Catchpole, M. (Marina)  
Coard, M. (Mary)  
Cobbing, C. (Cynthia)  
Cosby, J. (Jean)  
Cowan, M. (Margaret)  
Cowings, E. (Liz)  
Cuthbert, D. (Dorothy)  
Davis, M. (Mary)  
Davison, C. (Cynthia)  
Dineen, J. (Joan)  
Donachey, C. (Cathy)  
Donkin, E. (Esther)  
Dodd, M. (Marjorie)

### Men's Section

Adam, G. (Graham)  
Anderson, M. (Mike)  
Armstrong, B. (Brian)  
Arrowsmith, W.S. (Bill)  
Ashford, B. (Bryan)  
Asmussen, C. (Colin)  
Atkinson, A. (Andrew)  
Atkinson, J.W. (Jack)  
Attwater, G. (Gerald)  
Baker, A.H. (Arthur)  
Baker, R.I. (Richard)  
Barnfather, A. (Alan)  
Barratt, A. (Tony)  
Barritt, A.D. (Alan)  
Barrons, W. (Billy)  
Baxter, R.B. (Bob)  
Bell, E.P. (Percy)  
Bell, T.A.W. (Andrew)  
Bell, W. (Billy)  
Bennett, G.D. (Geoff)  
Bennett, M.A. (Michael)  
Berry, G. (George)  
Boland, D. (Don)  
Boothby, D. (Derek)  
Bowmer, G. (George)  
Brennan, M.L. (Malcolm)  
Brown, G. (Geoffrey)  
Brown, R. (Bob)  
Bruce, T.S. (Tom)  
Bryson, C. (Crosby)  
Buchanan, N. (Neil)  
Buckley, H. (Harold)  
Burbeck, D. (Don)  
Burn, J. (John)  
Burn, T.R. (Tom)  
Burnip, G. (Grahame)  
Cahill, I. (Ian)

## Ladies' Section

Dodds, M. (Margery)  
Driver, O. (Olive)  
Duff, M. (Marjorie)  
Edwards, R. (Ruth)  
Emery / Crofts, D. (Dorothy)  
Emmerson, E. (Liz)  
English, J. (June)  
Fletcher, I. (Iris)  
French, E. (Elizabeth)  
Furniss, H. (Hazel)  
Galbraith, J. (Joyce)  
Gatenby, E. (Ena)  
Gibson, M. (Margaret)  
Gill, A. (Anne)  
Goldie, M. (Mae)  
Graham, A. (Ann)  
Graham, J. (Joan)  
Green, D. (Doreen)  
Grieve, B. (Beatrice)  
Harrison, L. (Lilian)  
Haylock, P. (Pat)  
Healy, M. (Muriel)  
Howell, J. (Joan)  
Jackson, J. (Joyce)  
Jeffer, F. (Frances)  
Johnson, R. (Rose)  
Johnston, B. (Betty)  
Jordan, G. (Gina)  
Kilmister, M. (Marilyn)  
Leiper, E. (Eleanor)  
Liddle, G. (Gemma)  
Linthwaite, M. (Margaret)  
Little, M. (Mary)  
Lonsdale, V. (Vera)  
Loughton, L.H. (Lilian)  
Lowe, A. (Ann)  
Lowthian, M. (Margaret)  
Lumley, D. (Doreen)  
MacLeod, A.O. (Nan)  
Mannings, M. (Margaret)  
Marsh, L. (Lesley)  
Marshall, J. (Jean)  
Marshall, J. (Joan)  
Mason, C. (Chris)  
McDonald, F. (Florence)  
McDonnell, D.A. (Di)  
Mills, E.. (Eve)  
Mole, J. (Jenny)  
Myers, M. (Peggy)  
Nesbit, M.E.H. (Betty)  
Newton, E. (Ethel)  
Nichol, J. (June)  
Nixon, J. (Jenifer)  
O'Rourke, S. (Shelley)  
Olds, W. (Winifred)  
Ortton, N.F. (Nora)

## Men's Section

Caldwell, E. (Ted)  
Carr, D. (David)  
Carr, J. (Jim)  
Cassidy, G. (Ged)  
Cassie, C. (Cliff)  
Cattliff, T. (Tom)  
Christie, A.O. (Sandy)  
Collins, L. (Les)  
Cordingley, P. (Peter)  
Cowings, J.D. (Dave)  
Crabb, J.W. (Jack)  
Crofts, L. (Len)  
Crozier, D.C. (David)  
Cuthbert, T.W. (Tom)  
Daunt, G. (Geoff)  
Davis, H. (Harry)  
Dodds, P.A. (Peter)  
Donkin, R. (Dick)  
Douglas, W.S. (Bill)  
Downing, D. (David)  
Driver, J. (Jack)  
Duff, J.S. (John)  
Dunn, D. (Dennis)  
Edison, M. (Mike)  
Edwards, D.T. (Ted)  
Elder, R. (Ron)  
Emery, H. (Harry)  
Endersby, W. (Bill)  
English, J. (John)  
Fatkin, T. (Tommy)  
Foreman, B. (Brian)  
Forster, E. (Ted)  
Franks, D. (Donald)  
French, N. (Norman)  
Gatenby, J. (John)  
Gibb, D. (Don)  
Gill J.M. (John)  
Goldie, G. (George)  
Graham, J. (John)  
Griffiths, K. (Ken)  
Harper, A. (Alec)  
Harrison, J.T. (Tom)  
Harrison, K. (Ken)  
Henderson, J. (Joe)  
Hepple, W.L. (Billy)  
Hill, H. (Harry)  
Hilton, J. (James)  
Hindmarsh, D. (David)  
Holt, F. (Frank)  
Horsfall, R. (Bob)  
Howard, W. (Bill)  
Howell, H. (Harry)  
Howes, A. (Alan)  
Hoy, J. (James)  
Hudson, D. (Doug)  
Hunter, K. (Ken)

## Ladies' Section

Owen, F. (Freda)  
Pascoe, E. (Betty)  
Pearson, A. (Ann)  
Peterson, M. (Marian)  
Pirnie, M.N. (Nancy)  
Porritt, L. (Lorna)  
Pringle, J. (Joyce)  
Ramsay, E.J. (Jean)  
Richardson, M. (Margaret)  
Richley, I. (Iris)  
Riddell / Buckley, B.B. (Beatrice)  
Ridley, S.M. (Sylvia)  
Robinson, M. (Mary)  
Roper, E.M. (Em)  
Rochester, R. (Ruth)  
Rutherford, N. (Noreen)  
Rutter, A. (Ann)  
Scarlett, M. (Marjorie)  
Scott, E. (Ella)  
Shiple, A.. (Amanda)  
Shuttleworth, E. (Elaine)  
Shuttleworth, M. (Maria)  
Smith, J. (Joan)  
Smith, S. (Sylvia)  
Stafford, B. (Brenda)  
Stapylton, G. (Gloria)  
Stockman, L. (Lil)  
Storey, S.A. (Allison)  
Stuart, M. (Mary)  
Sutherland, M. (Margaret)  
Tailford, M. (Mary)  
Tate, W. (Wendy)  
Taylor, D. (Dot)  
Taylor, M. (Muriel)  
Telfer, L. (Lorna)  
Telfer, V. (Val)  
Tough, J. (Julie)  
Trimble, E. (Betty)  
Trimble, J. (Jean)  
Twizell, R. (Rita)  
Varley, P. (Pamela)  
Waddell, H. (Hazel)  
Walters, E. (Ellenor)  
Walwyn-James, D. (Doreen)  
Williamson, M. (Marjorie)  
Woodhouse, M. (Margaret)  
Wright, K. (Kath)  
Wright, T. (Thelma)  
Young, I. (Irene)  
Younger, E. (Ena)

## Men's Section

Ions, C.R. (Charlie)  
Ions, J.A. (Jimmy)  
Irvine, J. (John)  
Jameson, C.F. (Fred)  
Jones, E.H. (Ted)  
Kelly, E. (Ned)  
Kennerley, D.G. (David)  
Kilmister, P. (Peter)  
Kinnear, H. (Harry)  
Kirk, D.W. (Dave)  
Kitto, F.L. (Frank)  
Knight, F. (Fred)  
Lane, A.S. (Bert)  
Latham, G. (George)  
Lees, J.H. (John)  
Leonard, G. (Geoff)  
Liddle, W.R. (Bob)  
Linley, G. (Gary)  
Linley, J.R. (Jack)  
Longstaff, G. (George)  
Loughton, F.E. (Frank)  
Loughton, J. (Joe)  
Lord, G. (Graham)  
Lowe, G. (Geoff)  
Lowthian, E.W. (Ernest)  
Lumley, T. (Tom)  
Lumbsden, B. (Brian)  
Lunn, J. (John)  
Lyon, R. (Ray)  
Maclean, A.M. (Murray)  
Madison, R. (Roland)  
Mahmood, A. (Azhar)  
Main, J.A. (Jim)  
Mankin, L.R. (Len)  
Manson, P. (Peter)  
Marshall, W.D. (Duncan)  
Marshall, E. (Eric)  
Marshall, F. (Fergus)  
Martin, T. (Tom)  
Mattison, J.L. (Les)  
McDonald, G.H. (George)  
McDonnell, M. (Mike)  
McMillan, A. (Alex)  
McPhee, T. (Tom)  
Meek, R. (Dick)  
Middlemiss, W. (Walter)  
Mills, T. (Tom)  
Mitchell, J. (John)  
Mole, W. (Bill)  
Moorhead, J.M. (Jack)  
Morley, E. (Ernest)  
Morley, J. (John)  
Morrison, D.W. (Dave)  
Moxon, E. (Eddie)  
Neale, C.F. (Charles)  
Nesbit, J.W. (John)

## **Men's Section**

**Nichol, T. (Tom)**  
**Nichol, T. (Tommy)**  
**Nicholson, G.C. (Cecil)**  
**Noble, D. (David)**  
**Oliver, J. (Joe)**  
**O'Rourke, M. (Mike)**  
**Pascoe, R.F. (Dick)**  
**Pearson, R. (Bob)**  
**Peckham, R.A. (Ron)**  
**Potts, R. (Ron)**  
**Preston, K. (Keith)**  
**Pringle, G. (George)**  
**Pringle, M. (Michael)**  
**Redhead, R.D. (David)**  
**Reid, A. (Alex)**  
**Richley, J. (Jonathan)**  
**Ridley, A. (Alan)**  
**Ridley, A. (Arthur)**  
**Ridley, W. (Bill)**  
**Roberts, J. (Jim)**  
**Roberts, J. (John)**  
**Robinson, A. (Otto)**  
**Robinson, H.S. (Bert)**  
**Robinson, W. (Bill)**  
**Robson, H. (Harry)**  
**Robson, T.N. (Norman)**  
**Rutherford, S. (Stan)**  
**Rutter, R. (Dick)**  
**Ryder, P. (Peter)**  
**Scholes, E. (Eric)**  
**Selby, R. (Bob)**  
**Shepley, G. (Graham)**  
**Shuttleworth, R.I. (Ron)**  
**Skinner, G. (Gordon)**  
**Slater, J. (John)**  
**Smith, J. (Jim)**  
**Smith, R. (Ron)**  
**Stafford, R. (Ron)**  
**Stobert, H.B. (Henry)**  
**Stoker, J. (Jack)**  
**Stokoe, E. (Ted)**  
**Stonehouse, R. (Ray)**  
**Straughan, K.B. (King)**  
**Straughan, W.M. (William)**  
**Swift, S.A. (Andrew)**  
**Symonds, R. (Richard)**  
**Taylor, C. (Colin)**  
**Taylor, J. (Jim)**  
**Telfer, P. (Percy)**  
**Thompson, D. (Duncan)**  
**Tingcombe, J.C. (Jack)**  
**Titman, C. (Clive)**  
**Turner, A. (Archie)**  
**Turner, J. (John)**

## **Men's Section**

**Urwin, W. (Billy)**  
**Varley, J.S. (Jim)**  
**Varley, R.J. (Richard)**  
**Vine, S. (Sid)**  
**Waller, J. (Jack)**  
**Walters, C. (Charles)**  
**Warner, G. (Geoff)**  
**Watson, E. (Eric)**  
**Wearmouth, M. (Max)**  
**Webb, G. (George)**  
**Weightman, W. (Bill)**  
**White, D. (Doug)**  
**Wilcock, G.M. (Geoff)**  
**Wilkinson, A. (Alan)**  
**Wilkinson, R.S. (Bob)**  
**Wilson, A. (Alan)**  
**Wilson, P.A. (Peter)**  
**Wilson, W. (Billy)**  
**Wilson, W. (William)**  
**Wintrip, T. (Tommy)**  
**Wood, H. (Harold)**  
**Wood, J. (Joe)**  
**Wood, K.D. (Keith)**  
**Woodhouse, F. (Frank)**  
**Wright, B.D.W. (Bernard)**  
**Wright, S. (Stan)**  
**Yates, W.R. (Rowley)**  
**Young, A. (Archie)**  
**Young, R.**  
**Younger, N.I. (Norman)**

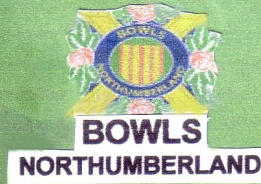

Bowls has been played in all of the English-speaking countries and more recently taken up in Europe. During its long history dating back to the 13th Century, it was banned by both king and parliament it being considered a hindrance to training men in the skills of archery for military purposes. Proclamations forbade it along with other forms of recreation during the reigns of Edward III and Richard II. The ban remained long after the use of bows and the introduction of muskets and other weapons. Although some may be unmindful of its history, the game of bowls has proved to be an enjoyable pastime for members of Ponteland bowling club. This account provides a credible record of social events and bowling achievements of members since its foundation in 1923 and centennial celebration in 2023.

100  
YEARS

